

User Manual

Tektronix

CTS 710
SONET Test Set
070-8852-03

This document applies to firmware version 1.3
and above.



Copyright © Tektronix, Inc. 1994. All rights reserved.

Tektronix products are covered by U.S. and foreign patents, issued and pending. Information in this publication supercedes that in all previously published material. Specifications and price change privileges reserved.

Tektronix, Inc., **P.O. Box 500, Beaverton, OR, 97077**

TEKTRONIX and TEK are registered trademarks of Tektronix, Inc.

WARRANTY

Tektronix warrants that this product will be free from defects in materials and workmanship for a period of three (3) years from the date of shipment. If any such product proves defective during this warranty period, Tektronix, at its option, either will repair the defective product without charge for parts and labor, or will provide a replacement in exchange for the defective product.

In order to obtain service under this warranty, Customer must notify Tektronix of the defect before the expiration of the warranty period and make suitable arrangements for the performance of service. Customer shall be responsible for packaging and shipping the defective product to the service center designated by Tektronix, with shipping charges prepaid. Tektronix shall pay for the return of the product to Customer if the shipment is to a location within the country in which the Tektronix service center is located. Customer shall be responsible for paying all shipping charges, duties, taxes, and any other charges for products returned to any other locations.

This warranty shall not apply to any defect, failure or damage caused by improper use or improper or inadequate maintenance and care. Tektronix shall not be obligated to furnish service under this warranty a) to repair damage resulting from attempts by personnel other than Tektronix representatives to install, repair or service the product; b) to repair damage resulting from improper use or connection to incompatible equipment; or c) to service a product that has been modified or integrated with other products when the effect of such modification or integration increases the time or difficulty of servicing the product.

THIS WARRANTY IS GIVEN BY TEKTRONIX WITH RESPECT TO THIS PRODUCT IN LIEU OF ANY OTHER WARRANTIES, EXPRESSED OR IMPLIED. TEKTRONIX AND ITS VENDORS DISCLAIM ANY IMPLIED WARRANTIES OF MERCHANTABILITY OR FITNESS FOR A PARTICULAR PURPOSE. TEKTRONIX' RESPONSIBILITY TO REPAIR OR REPLACE DEFECTIVE PRODUCTS IS THE SOLE AND EXCLUSIVE REMEDY PROVIDED TO THE CUSTOMER FOR BREACH OF THIS WARRANTY. TEKTRONIX AND ITS VENDORS WILL NOT BE LIABLE FOR ANY INDIRECT, SPECIAL, INCIDENTAL, OR CONSEQUENTIAL DAMAGES IRRESPECTIVE OF WHETHER TEKTRONIX OR THE VENDOR HAS ADVANCE NOTICE OF THE POSSIBILITY OF SUCH DAMAGES.

Table of Contents

General Safety Summary	xvii
Preface	xxi
How This Manual is Organized	xxi
Conventions	xxi
Related Manuals	xxii
Using the CTS 710 Reference	xxiii

Getting Started

Getting Started	1-1
Product Description	1-1
Accessories	1-2
Standard Accessories	1-2
Optional Accessories	1-2
First Time Operation	1-3
Installing the Accessory Pouch	1-3
Setting Up the CTS 710	1-7
Turning On the CTS 710	1-9
Turning Off the CTS 710	1-10

Operating Basics

Functional Overview	2-1
Front-Panel Controls, Indicators, and Connectors	2-2
Rear-Panel Controls and Connectors	2-4
Front-Panel Status Lights	2-4
Reading the Display	2-6
The Basic Menu Structure	2-9
What is a Menu?	2-9
Selecting Menus	2-11
Selecting Pages	2-11
Displaying Help	2-12
Connecting Signals	2-13
Connecting Optical Signals	2-14
Connecting SONET Electrical Signals	2-15
Connecting DS1/DS3 Electrical Signals	2-15
Initiating Autoscan	2-15

Changing Parameters	2-15
Selecting Parameters	2-16
Selecting from Lists	2-16
Changing Decimal Numbers	2-17
Changing Binary Numbers	2-20
Entering Text	2-21
Working with the Disk Drive	2-23
Reading Files on Disk	2-24
Tutorial	2-27
Before Turning On the CTS 710	2-27
Setting Transmit Parameters	2-28
Setting Receive Parameters	2-30
Setting the Test Time	2-31
Where Test Results Are Displayed	2-32
Begin the Test	2-33
Inserting Errors	2-34
Adjusting Pointers	2-36
Viewing Transport Overhead	2-40
Editing the Transport Overhead	2-41
Viewing Test Results	2-43

Reference

Basic Test Procedures	3-1
Setting Up the CTS 710	3-1
Network Continuity Checking	3-2
Transmission Signal Quality Testing	3-4
Measuring Bit Error Rate	3-4
Testing Mapping and Demapping	3-6
Fault Tolerance Checking	3-8
Response to Errors and Alarms	3-8
Response to Pointer Movements	3-13
Response to Line Frequency Offset	3-16
Performance Monitoring	3-18
Setting Test Control Parameters	3-23
Setting the Test Time Duration	3-23
Setting a Unique Test Time Duration	3-24
Setting the History Resolution	3-26

Starting and Stopping a Test	3-27
Making Changes While Running a Test	3-28
Actions You Cannot Perform While Running a Test	3-28
Working with Test Setups	3-31
Saving and Recalling Instrument Setups	3-31
Saving Instrument Setups	3-32
Recalling Instrument Setups	3-34
Recalling the Default Factory Setup	3-35
Deleting Instrument Setups from Disk	3-36
Pass/Fail Tests	3-37
Parameters of a Pass/Fail Test	3-37
Fail If Conditions	3-38
Creating a Pass/Fail Test	3-44
Running a Pass/Fail Test	3-49
Changing an Existing Pass/Fail Test	3-51
Deleting a Pass/Fail Test from Disk	3-53
Checking Signal Status	3-55
Viewing Signal Structure	3-55
Viewing the Payload (Add/Drop/Test Option Only)	3-56
Determining the Payload Pattern and Framing (Add/Drop/Test Option Only)	3-57
Printing the AutoScan Dialog Box	3-58
Viewing the Signal State	3-58
Extended Status	3-61
Setting the Beeper	3-61
Setting SONET Transmit Parameters	3-63
Steps for Setting Parameters	3-63
Setting the Transmit Rate	3-64
Independent Transmit and Receive Settings	3-64
Coupling Transmit and Receive Settings	3-65
Through Mode	3-67
Setting the Transmit Clock	3-68
Setting the Transmit Level	3-69
Setting the Signal Structure	3-69
Specifying the STS to Test	3-70
Setting the Payload Mapping	3-71
Unequipped Payload Mapping	3-72

Mapping a Tributary Signal (Add/Drop/Test Option Only) . . .	3-72
Mapping a Tributary with VT1.5 Floating Async Payload	
Mapping	3-72
Setting the Test Pattern	3-75
Setting Overhead Bytes	3-77
How to Edit an Overhead Byte	3-77
Editing the V5 Byte	3-80
Bytes You Cannot Edit	3-81
Editing the J1 Path Trace Byte	3-82
Adding DCC and User Channel Overhead Bytes	3-84
Setting Tributary Signal Transmit Parameters	3-89
Steps for Setting Parameters	3-89
Setting the Transmit Rate	3-90
Independent Transmit and Receive Settings	3-90
Coupling Transmit and Receive Settings	3-90
Setting the Transmit Clock	3-92
Setting the Line Clock Offset	3-93
Setting the Transmit Line Code	3-93
Specifying the Framing	3-94
Specifying the Test Pattern	3-96
Setting SONET Receive Parameters	3-99
Steps for Setting Parameters	3-99
Setting the Receive Rate	3-100
Independent Receive and Transmit Settings	3-101
Coupling Receive and Transmit Settings	3-101
Setting the Receive Level	3-103
Setting the Signal Structure	3-103
Specifying Which STS to Test	3-104
Setting the Mapping	3-104
Demultiplexing a DS1 from a DS3 Mapped in a SONET Signal (Add/Drop/Test Option Only)	3-107
Demapping a Tributary Signal (Add/Drop/Test Option Only) .	3-110
Dropping a Tributary Signal	3-111
Setting the Test Pattern	3-113
Unequipped Payload Mapping	3-114
Checking Received Optical Power or Received Peak Voltage .	3-114

Viewing Overhead Bytes	3-115
Viewing Transport Overhead Bytes	3-115
Viewing Path Overhead Bytes	3-116
Displaying the J1 Path Trace Message	3-116
Displaying the V5 Byte	3-117
Dropping DCC and User Channel Overhead Bytes	3-117
Controlling the Display Update	3-120
Setting Tributary Receive Parameters	3-121
Steps for Setting Parameters	3-121
Setting the Receive Rate	3-122
Independent Receive and Transmit Settings	3-123
Coupling Receive and Transmit Settings	3-123
Setting the Receive Level	3-124
Setting the Framing	3-124
Specifying the Test Pattern	3-125
Demultiplexing a DS1 from a DS3 Signal	3-127
Setting Alarms and Inserting Errors	3-131
Simulating Error Conditions	3-131
Specifying the Error to Insert	3-132
Inserting Errors	3-133
Setting Alarms	3-135
Simulating Transmit Failures	3-138
Setting Pointers and Changing Timing	3-141
Setting Pointers	3-141
Manual Pointer Control	3-142
Continuous Pointer Movement	3-147
Changing Timing	3-149
Generating Pointer Sequences	3-151
Starting Pointer Sequences	3-156
Testing Automatic Protection Switching	3-161
Setting the APS Mode	3-161
Setting the K1 Byte	3-162
Setting the K2 Byte	3-166
Transmitting the K1 and K2 Bytes	3-170
Viewing the Network Response to APS Commands	3-172
Viewing Results	3-173
Viewing a Summary of Results	3-173

Viewing Detailed Results	3-174
Displaying an Overview of Test Results	3-175
Displaying an Analysis of Test Results	3-177
Viewing Measurement Histories	3-181
Types of Graphs	3-182
Elements of the History Graph Display	3-186
Graph Name	3-186
History Resolution	3-186
Power Out Indicator	3-187
Cursor	3-187
Cursor Position	3-187
Measurement Results at Cursor Position	3-187
Zooming History Graphs	3-188
Panning History Graphs	3-190
Changing the Displayed History Graph	3-190
Displaying Mini-Graphs	3-191
Saving and Recalling Results	3-192
Saving Test Results to Disk	3-192
Recalling Test Results from Disk	3-194
Deleting Test Results from Disk	3-195
Recalling Test Results from Memory	3-196
Printing Results	3-196
Printing Main Results or Error Analysis	3-196
Printing History Graphs	3-198
Changing Instrument Settings	3-199
Viewing the Instrument Configuration	3-199
Setting the Display Brightness	3-200
Turning the Beeper On and Off	3-201
Setting the Date	3-202
Setting the Time	3-202
Changing the Printer Setup	3-203
Specifying the Printer or File Type	3-204
Setting RS-232 Parameters	3-204
Setting the Print User & Company Text	3-206
Setting Remote Control Parameters	3-206
Setting the GPIB Address	3-207
Setting RS-232 Parameters	3-208

Running Instrument Self Tests	3-210
Running the Power Up Self Test	3-211

Appendices

Appendix A: Menu Maps	A-1
TEST CONTROL Page	A-1
RECALL INSTRUMENT SETUPS Page	A-1
RECALL PASS/FAIL TESTS Page	A-2
SAVE INSTRUMENT SETUPS Page	A-2
SAVE PASS/FAIL TESTS Page	A-3
TRANSMIT SETTINGS Page (1 of 2)	A-4
TRANSMIT SETTINGS Page (2 of 2)	A-5
ERRORS & ALARMS Page (1 of 4)	A-6
ERRORS & ALARMS Page (2 of 4)	A-7
ERRORS & ALARMS Page (3 of 4)	A-8
ERRORS & ALARMS Page (4 of 4)	A-9
POINTERS & TIMING Page (1 of 3)	A-10
POINTERS & TIMING Page (2 of 3)	A-11
POINTERS & TIMING Page (3 of 3)	A-12
APS COMMANDS Page (1 of 3)	A-13
APS COMMANDS Page (2 of 3)	A-14
APS COMMANDS Page (3 of 3)	A-15
TRANSPORT OVERHEAD Page	A-16
PATH OVERHEAD Page	A-17
RECEIVE SETTINGS Page (1 of 2)	A-18
RECEIVE SETTINGS Page (2 of 2)	A-19
SIGNAL STATUS Page	A-20
TRANSPORT OVERHEAD Page	A-20
PATH OVERHEAD Page	A-21
TEST SUMMARY Page	A-21
MAIN RESULTS Page	A-22
ERROR ANALYSIS Page	A-22
HISTORY GRAPHS Page	A-23
SAVE RESULTS Page	A-24
RECALL RESULTS Page	A-24
MISC SETTINGS Page	A-24
PRINTER SETUP Page	A-25
REMOTE CONTROL Page	A-26
INSTR CONFIG Page	A-27
SELF TEST Page	A-27

Appendix B: Status and Error Messages	B-1
Status Messages	B-1
Error Messages	B-3
Appendix C: Default Factory Settings	C-1
Appendix D: Specifications	D-1
Appendix E: Incoming Inspection Test	E-1
Loop-Back Connection	E-2
How to Proceed	E-3
System Self Test with External Loop-Back	E-3
SONET Signals	E-4
Tributary Signals (Add/Drop/Test Option Only)	E-6
Appendix F: Example Disk Contents	F-1
Instrument Setups	F-1
Test Results	F-1
Pass/Fail Tests	F-1
Appendix G: Rear-Panel Connectors	G-1
VGA Video Output	G-1
GPIB Port	G-3
RS-232 Port	G-3
External Clock Input	G-4
Calibration Signal Output	G-4
Overhead Add/Drop Port	G-5
BITS Timing Reference Input	G-7
Appendix H: Changing Optical Port Connectors	H-1
Cleaning the Optical Ports	H-1
Changing the Optical Port Connectors	H-2
Appendix I: Packing for Shipment	I-1

Glossary and Index

List of Figures

Figure i: Placing the Reference for Easy Viewing	xxiii
Figure 1–1: Installing the Accessory Pouch	1–4
Figure 1–2: Inserting the Pouch Under the Front Panel Trim	1–5
Figure 1–3: Location of the D-Ring on the Accessory Pouch	1–6
Figure 1–4: Rear-Panel Controls and Connectors Used in Setup	1–8
Figure 1–5: ON/STBY Button	1–10
Figure 2–1: Controls Located Around the Display	2–2
Figure 2–2: Front-Panel Controls, Indicators, and Connectors	2–3
Figure 2–3: Rear-Panel Controls and Connectors	2–4
Figure 2–4: Status Lights (With Option 22 Installed)	2–5
Figure 2–5: Major Areas of the Display	2–6
Figure 2–6: Specific Elements of the Display	2–7
Figure 2–7: The Five Menus	2–9
Figure 2–8: Menus and Pages	2–10
Figure 2–9: Menu Select Buttons	2–11
Figure 2–10: How to Display a Page	2–12
Figure 2–11: Help Dialog Box	2–13
Figure 2–12: Selecting a Parameter	2–16
Figure 2–13: Selecting Choices From a List	2–17
Figure 2–14: Selecting USER DEFINED	2–18
Figure 2–15: Entering a Numeric Value	2–19
Figure 2–16: Selecting a Byte for Editing	2–20
Figure 2–17: Editing a Byte	2–21
Figure 2–18: Selecting a Text String for Editing	2–22

Figure 2–19: Editing a Text String	2–23
Figure 2–20: Setup for the Tutorial	2–28
Figure 2–21: The TRANSMIT SETTINGS Page of the TRANSMIT Menu	2–29
Figure 2–22: The TEST TIME Page of the UTILITY Menu	2–31
Figure 2–23: The TEST SUMMARY Page of the RESULTS Menu	2–32
Figure 2–24: The MAIN RESULTS Page of the RESULTS Menu	2–33
Figure 2–25: The Message Line and Test Status Indicator .	2–34
Figure 2–26: The ERRORS & ALARMS Page of the TRANSMIT Menu	2–35
Figure 2–27: The POINTERS & TIMING Page of the TRANSMIT Menu	2–37
Figure 2–28: Adjusting Frequency Offset Using the Knob .	2–39
Figure 2–29: The TRANSPORT OVERHEAD Page of the TRANSMIT Menu	2–41
Figure 2–30: The Display in Edit Mode	2–42
Figure 2–31: The TEST SUMMARY Page of the RESULTS Menu	2–44
Figure 2–32: The MAIN RESULTS Page of the RESULTS Menu	2–45
Figure 3–1: Setup to Check Network Continuity	3–2
Figure 3–2: Setup to Check a Transmission Link	3–4
Figure 3–3: Setup to Test Mapping and Demapping	3–6
Figure 3–4: Setup to Check Error and Alarm Response ...	3–9
Figure 3–5: Setup to Check Pointer Movements	3–14
Figure 3–6: Setup to Check Line Frequency Offset Response	3–16
Figure 3–7: Setup to Monitor Performance	3–19
Figure 3–8: The Test Control Page	3–24
Figure 3–9: Setting a USER DEFINED Test Duration	3–25

Figure 3–10: Elapsed Time and Bar Graph Indicators	3–28
Figure 3–11: The SAVE INSTRUMENT SETUPS Page . . .	3–33
Figure 3–12: The RECALL INSTRUMENT SETUPS Page	3–35
Figure 3–13: Selecting a Disk File for Deleting	3–36
Figure 3–14: The SAVE PASS/FAIL TESTS Page	3–37
Figure 3–15: Entering Fail If Conditions	3–47
Figure 3–16: The TEST BEGIN Dialog Box	3–51
Figure 3–17: Selecting a Pass/Fail Test for Deleting	3–53
Figure 3–18: The AUTOSCAN Dialog Box Showing Signal Structure	3–56
Figure 3–19: Viewing Tributary Signal Structure	3–57
Figure 3–20: The Meaning of the Icons in the Autoscan Dialog Box	3–58
Figure 3–21: Front-Panel Status Lights (with Add/Drop/Test Option Installed)	3–59
Figure 3–22: Sequence for Setting SONET Signal Parameters	3–63
Figure 3–23: Sequence for Setting SONET Signal Parameters When Mapping a Tributary Signal	3–64
Figure 3–24: SONET Transmit Rates	3–65
Figure 3–25: CTS 710 in Through Mode	3–68
Figure 3–26: Mapping a Tributary Signal	3–73
Figure 3–27: Editing the User Word Byte	3–77
Figure 3–28: Editing the Z2 Transmit Overhead Byte	3–79
Figure 3–29: Editing an Overhead Byte	3–80
Figure 3–30: Editing the J1 Path Trace Byte	3–84
Figure 3–31: Adding Data into the DCC	3–86
Figure 3–32: Adding Data into the User Channel	3–87
Figure 3–33: Sequence for Setting Tributary Signal Parameters	3–89
Figure 3–34: Tributary Transmit Rates	3–91
Figure 3–35: Editing the User Word	3–97

Figure 3–36: Sequence for Setting SONET Signal Parameters	3–99
Figure 3–37: Sequence for Setting SONET Signal Parameters When Demapping a Tributary Signal	3–100
Figure 3–38: SONET Receive Rates	3–101
Figure 3–39: Setting Tributary Mapping	3–110
Figure 3–40: Displaying Received Optical Power	3–115
Figure 3–41: J1 Path Trace Message Received by the CTS 710	3–117
Figure 3–42: Dropping Data from the DCC	3–118
Figure 3–43: Dropping the User Channel Data Byte	3–119
Figure 3–44: Sequence for Setting Tributary Signal Parameters	3–121
Figure 3–45: Sequence for Setting Signal Parameters to Demultiplex a DS1 from a DS3	3–121
Figure 3–46: Tributary Signal Receive Rates	3–122
Figure 3–47: Setting An Error Rate	3–135
Figure 3–48: Manual Pointer Control Choices	3–142
Figure 3–49: Alternating Burst Pointer Movement	3–144
Figure 3–50: Incrementing Pointer Location Once Every Two Milliseconds	3–149
Figure 3–51: Offsetting the Transmit Rate by +4.6 ppm ...	3–151
Figure 3–52: The Three Periods of a Pointer Sequence	3–152
Figure 3–53: An Example of a Pointer Sequence	3–153
Figure 3–54: Status Display While Pointer Sequences are Running	3–160
Figure 3–55: The APS COMMANDS Page	3–162
Figure 3–56: The RECEIVE Column on the APS COMMANDS Page	3–172
Figure 3–57: The Test Summary Page	3–174
Figure 3–58: Bar Graphs Showing Code Violations and Errored Seconds	3–182

Figure 3–59: Line Graph Showing Pointer Value	3–184
Figure 3–60: On/Off Graphs Showing Failures and Alarms	3–185
Figure 3–61: Elements of a History Graph	3–188
Figure 3–62: Changing the Displayed History Graph	3–191
Figure 3–63: The SAVE RESULTS Page	3–193
Figure 3–64: The RECALL RESULTS Page	3–195
Figure 3–65: The PRINT CONTROL Dialog Box	3–197
Figure 3–66: The MISC SETTINGS Page	3–201
Figure 3–67: The PRINTER SETUP Page	3–203
Figure 3–68: The REMOTE CONTROL Page	3–208
Figure E–1: Front-Panel Status Lights	E–1
Figure G–1: CTS 710 Rear Panel Connectors	G–1
Figure G–2: The VGA Video Output Connector	G–2
Figure G–3: The RS-232 Port	G–3
Figure G–4: The Overhead Add/Drop Port	G–5
Figure H–1: Removing the Optical Bulkhead Connector ..	H–2
Figure H–2: FC Optical Bulkhead Assembly	H–3
Figure H–3: ST Optical Bulkhead Assembly	H–3
Figure H–4: DIN 47256 Optical Bulkhead Assembly	H–4
Figure H–5: SC Optical Bulkhead Assembly	H–4

List of Tables

Table 1–1: Fuse and Fuse Cap Part Numbers	1–8
Table 1–2: Power Requirements	1–9
Table 2–1: Icons that Appear in the Display	2–8
Table 2–2: CTS 710 Disk File Types	2–24
Table 3–1: LTE Responses to Errors and Alarms	3–9
Table 3–2: Test Duration Limits	3–26
Table 3–3: Actions You Cannot Perform While a Test is Running	3–29
Table 3–4: Fail If Conditions of a Pass/Fail Test	3–39
Table 3–5: Green Status Lights	3–59
Table 3–6: Red and Yellow Status Lights	3–60
Table 3–7: Choices for Bits 5, 6, and 7 of the V5 Byte	3–81
Table 3–8: Overhead Bytes That Cannot Be Edited	3–81
Table 3–9: Bytes You Cannot Edit Due to Parameter Settings	3–82
Table 3–10: Tributary Rate Line Codes	3–94
Table 3–11: Maximum Error Rates for SONET Signals ...	3–134
Table 3–12: Maximum Error Rates for Tributary Signals .	3–134
Table 3–13: Pointer Sequences Generated	3–153
Table 3–14: Availability of Pointer Sequences	3–155
Table 3–15: Status Lines for Pointer Sequences	3–160
Table 3–16: Choices for Bits 1–4 of the K1 Byte When Mode is Set to Ring	3–163
Table 3–17: Choices for Bits 1–4 of the K1 Byte When Mode is Set to Span	3–164
Table 3–18: Choices for Bits 5–8 of the K1 Byte	3–166
Table 3–19: Choices for Bits 1–4 of the K2 Byte	3–168

Table 3–20: Choices for Bit 5 of the K2 Byte When Mode is Set to Span	3–169
Table 3–21: Choices for Bit 5 of the K2 Byte When Mode is Set to Ring	3–169
Table 3–22: Choices for Bits 6–8 of the K2 Byte	3–170
Table 3–23: Results Displayed on MAIN RESULTS Page	3–175
Table 3–24: T1M1 Section Analysis Results Displayed on the ERROR ANALYSIS Page	3–178
Table 3–25: T1M1 Line Analysis Results Displayed on the ERROR ANALYSIS Page	3–178
Table 3–26: T1M1 Path Analysis Results Displayed on the ERROR ANALYSIS Page	3–179
Table 3–27: T1M1 VT1.5 Analysis Results Displayed on the ERROR ANALYSIS Page	3–179
Table 3–28: T1M1 Payload Analysis Results Displayed on ERROR ANALYSIS Page	3–180
Table 3–29: DS1 Path Analysis Results Displayed on ERROR ANALYSIS Page	3–181
Table 3–30: DS3 Path Analysis Results Displayed on ERROR ANALYSIS Page	3–181
Table 3–31: Measurements Displayed as Bar Graphs	3–183
Table 3–32: Measurements Displayed as a Line Graph	3–184
Table 3–33: Measurements Displayed as On/Off Graphs for SONET Rates	3–185
Table 3–34: Measurements Displayed as On/Off Graphs for Tributary Rates	3–186
Table 3–35: Time Represented by Bars on History Graph	3–188
Table 3–36: Lines of the Instrument Configuration Page	3–199
Table C–1: Default Factory Settings	C–1
Table D–1: Standard CTS 710 Specifications	D–1
Table D–2: Option 22 DS1/DS3/VT1.5 Capabilities	D–10

Table D-3: Environmental Specifications	D-17
Table D-4: Physical Characteristics	D-18
Table D-5: Certifications and Compliances	D-18
Table E-1: Required Equipment	E-2
Table G-1: VGA Video Output Connector Pin Assignment	G-2
Table G-2: RS-232 Rear Panel Connector Pin Assignment	G-3
Table G-3: Overhead Channels Added	G-5
Table G-4: Overhead Channels Dropped	G-6
Table G-5: Overhead Add/Drop Port Data Signal Pin Assignments	G-6
Table G-6: Overhead Add/Drop Port Additional Pin Assignments	G-7



General Safety Summary

Review the following safety precautions to avoid injury and prevent damage to this product or any products connected to it.

Only qualified personnel should perform service procedures.

To avoid potential hazards, use this product only as specified.

Injury Precautions

Use Proper Power Cord

To avoid fire hazard, use only the power cord specified for this product.

Avoid Electric Overload

To avoid electric shock or fire hazard, do not apply a voltage to a terminal that is outside the range specified for that terminal.

Ground the Product

This product is grounded through the grounding conductor of the power cord. To avoid electric shock, the grounding conductor must be connected to earth ground. Before making connections to the input or output terminals of the product, ensure that the product is properly grounded.

Do Not Operate Without Covers

To avoid electric shock or fire hazard, do not operate this product with covers or panels removed.

Use Proper Fuse

To avoid fire hazard, use only the fuse type and rating specified for this product.

Do Not Operate in Wet/Damp Conditions

To avoid electric shock, do not operate this product in wet or damp conditions.

Do Not Operate in Explosive Atmosphere

To avoid injury or fire hazard, do not operate this product in an explosive atmosphere.

Wear Eye Protection

To avoid eye injury, wear eye protection if there is a possibility of exposure to high-intensity rays.

Product Damage Precautions

Use Proper Power Source

Do not operate this product from a power source that applies more than the voltage specified.

Provide Proper Ventilation

To prevent product overheating, provide proper ventilation.

Do Not Operate With Suspected Failures

If you suspect there is damage to this product, have it inspected by qualified service personnel.

Safety Terms and Symbols

Terms in This Manual

These terms may appear in this manual:



WARNING. Warning statements identify conditions or practices that could result in injury or loss of life.



CAUTION. Caution statements identify conditions or practices that could result in damage to this product or other property.

Terms on the Product

These terms may appear on the product:

DANGER indicates an injury hazard immediately accessible as you read the marking.

WARNING indicates an injury hazard not immediately accessible as you read the marking.

CAUTION indicates a hazard to property including the product.

Symbols on the Product

The following symbols may appear on the product:



DANGER
High Voltage



Protective Ground
(Earth) Terminal



ATTENTION
Refer to
Manual



Double
Insulated

Certifications and Compliances

CSA Certified Power Cords

CSA Certification includes the products and power cords appropriate for use in the North America power network. All other power cords supplied are approved for the country of use.

Preface

This manual describes how to use the Tektronix CTS 710 SONET Test Set. This manual is your primary source of information about how the CTS 710 functions.

How This Manual is Organized

This manual is divided into four sections: *Getting Started*, *Operating Basics*, *Reference*, and *Appendices*.

- *Getting Started* provides an overview of the CTS 710 and describes first time operation.
- *Operating Basics* explains the basic principles of operating the CTS 710. The *Operating Basics* section also includes a tutorial which introduces you to most of the capabilities of the CTS 710 by having you run a BER test.
- *Reference* provides explanations of how to perform detailed tasks.
- The *Appendices* provide a listing of specifications, default factory settings, an incoming inspection test, and other useful information.

Conventions

This manual uses the following conventions:

- The names of front-panel controls and menus appear in all upper case letters, for example, TRANSMIT and HELP.
- Names appear in the same case in this manual as they appear on the display of the CTS 710, for example, Test Duration and USER DEFINED.
- Within a procedure, a specific button to be pressed or a parameter to be selected appears in boldface print. For example, press the **AUTOSCAN** button or select **Continuous**.

The *Tutorial* and the *Reference* sections frequently present procedures in tables. Perform the procedure by reading from left to right in the table (see example below). The word *none* in a cell indicates that no action is required.

Press Menu Button	Select Menu Page	Highlight Parameter	Select Choice
Begin here with Step 1	Step 2	Step 3	Step 4
		Step 5	Step 6
		Step 7	Step 8, CTS 710 instruction is complete

Some procedures require several iterations of highlighting parameters and selecting choices. Some procedures may require more than one menu button or menu page selection as well.

Related Manuals

The following documents are also available for the CTS 710 SONET Test Set:

- The *CTS 710 SONET Test Set Reference* (Tektronix part number 070-9336-XX) provides a quick overview of the menu structure, front-panel buttons, example alarm responses, and a glossary.
- The *CTS 710 SONET Test Set Programmer Manual* (Tektronix part number 070-8924-XX) describes how to control the CTS 710 using an instrument controller.
- The *CTS 710 SONET Test Set & CTS 750 SDH Test Set Reference* (Tektronix part number 070-8854-XX) provides a quick overview of the instrument programming commands.
- The *CTS 710 SONET Test Set & CTS 750 SDH Test Set Service Manual* (Tektronix part number 070-8853-XX) provides information on maintaining and servicing your instrument to the module level.

Using the CTS 710 Reference

The Reference presents an overview of the CTS 710 menu structure, front-panel buttons, examples of alarm responses, and a glossary. To store the Reference for easy viewing, fold the card to display the desired page and slide the card behind the window located on the inside of the top flap of the pouch (see Figure i).

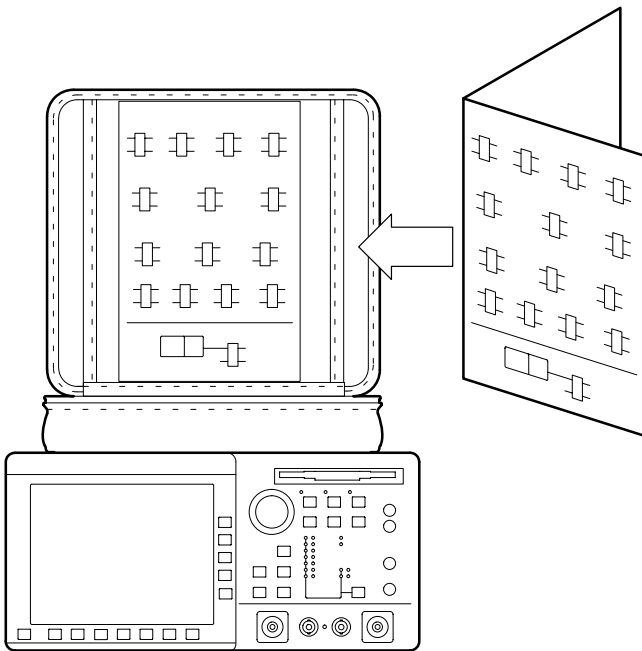

Figure i: Placing the Reference for Easy Viewing

Contacting Tektronix

Product Support	<p>For application-oriented questions about a Tektronix measurement product, call toll free in North America: 1-800-TEK-WIDE (1-800-835-9433 ext. 2400) 6:00 a.m. – 5:00 p.m. Pacific time</p> <p>Or contact us by e-mail: tm_app_supp@tek.com</p> <p>For product support outside of North America, contact your local Tektronix distributor or sales office.</p>
Service Support	<p>Contact your local Tektronix distributor or sales office. Or visit our web site for a listing of worldwide service locations.</p> <p>http://www.tek.com</p>
For other information	<p>In North America: 1-800-TEK-WIDE (1-800-835-9433) An operator will direct your call.</p>
To write us	<p>Tektronix, Inc. P.O. Box 1000 Wilsonville, OR 97070-1000</p>



Getting Started

Getting Started

This section provides a description of the CTS 710, a list of standard and optional accessories, and explains how to operate the CTS 710 for the first time.

Product Description

The Tektronix CTS 710 SONET Test Set is a rugged, portable test set designed for installing and maintaining telecommunications networks. The CTS 710 is a SONET analyzer that combines bit error rate test capabilities with overhead testing, payload mapping, and demapping in one unit. The CTS 710 features the following capabilities:

- STS-1, STS-3, OC-1, OC-3, OC-12, DS1, and DS3 transmit and receive
- Optical interface available at 1310 nm and 1550 nm
- Bit Error Rate testing
- BIP error monitoring and analysis
- Payload mapping and demapping
- Tributary Add/Drop/Test
- Pointer generation, including sequences, and analysis
- Alarm generation and analysis
- DS1/DS3 error monitoring and analysis
- DS1 Demultiplex from direct-input DS3 or a DS3 embedded in a SONET rate signal
- Performance monitoring
- APS testing
- DCC and user channel access
- Programmable via IEEE 488.2 and RS-232

The CTS 710 meets the needs of the craftsperson and the network engineer. The CTS 710 meets the requirements of those working in network installation and maintenance by providing the capability to perform:

- Network integrity testing
- In-service performance monitoring
- Stimulus and response testing
- Stress testing
- Overhead testing

Accessories

Some accessories are included with the CTS 710 SONET Test Set. If you wish to purchase optional accessories or additional standard accessories, see a Tektronix products catalog or contact your local Tektronix field representative.

Standard Accessories

- *CTS 710 SONET Test Set User Manual*, Tektronix part number 070-8852-XX
- *CTS 710 SONET Test Set Reference*, Tektronix part number 070-9336-XX
- Instrument Front Cover, Tektronix part number 200-3232-XX
- 75 Ω loopback cable, Tektronix part number 012-1338-XX
- Pouch, Tektronix part number 016-1266-XX

Optional Accessories

- *CTS 710 SONET Test Set Programmer Manual* (Tektronix part number 070-8924-XX)
- *CTS 710 SONET Test Set & CTS 750 SDH Test Set Reference*, Programming commands (Tektronix part number 070-8854-XX)

- *CTS 710 SONET Test Set & CTS 750 SDH Test Set Service Manual* (Tektronix part number 070-8853-XX)
- Hard Transit Case, Tektronix part number 016-1157-XX
- Soft Carrying Bag, Tektronix part number 016-1158-XX
- K212 Portable Instrument Cart
- Optical Connector Kit, Tektronix part number 020-1885-XX

First Time Operation

This section describes how to set up the CTS 710 for the first time.

Installing the Accessory Pouch

The CTS 710 ships with an accessory pouch that mounts on top of the instrument. The pouch is not installed at the factory. To install the accessory pouch:

1. Place the CTS 710 on a table or work bench with the front facing toward you.
2. Center the pouch plate and insert the rear edge of the plate in the space between the cabinet top and the rear panel trim (see part A of Figure 1-1).
3. Move the pouch sideways as necessary to line up the key slots in the pouch plate with the keys on the rear panel (the plate is centered when it is aligned) and push the plate all the way in (see part B of Figure 1-1).
4. While keeping the pouch plate pushed under the rear panel trim, reach under the pouch plate and carefully remove the backing from the Velcro strip to expose the adhesive on the Velcro strip. The Velcro should remain attached to the pouch plate.
5. Grasp the pouch plate assembly with both hands near the front of the assembly.

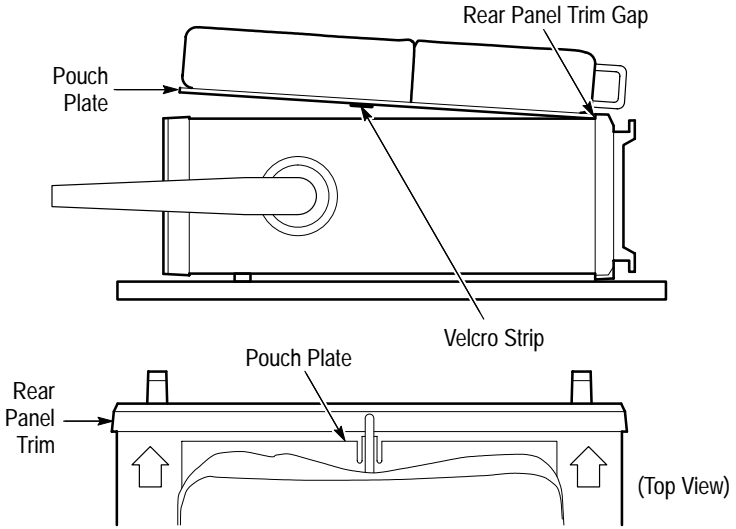

A. Push the pouch plate into the rear panel trim gap.

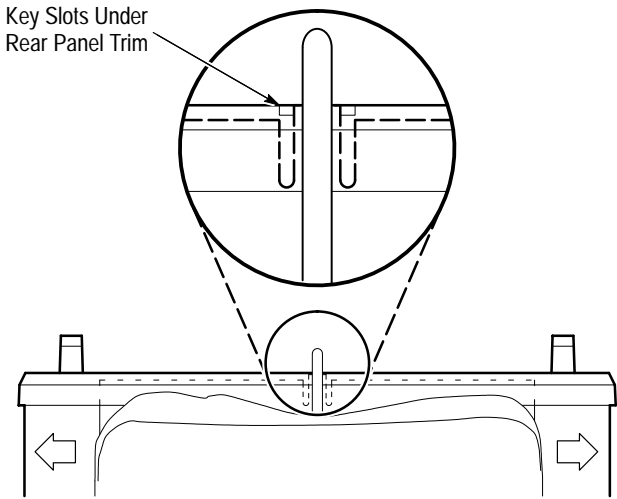

B. Center the pouch plate to align with key slot under the rear panel trim.

Figure 1-1: Installing the Accessory Pouch



CAUTION. In the next step, use only enough force to clear the front panel trim with the plate front edge. Excessive force will cause a permanent bow in the plate.

6. Push back on the pouch plate and press down with the heels of your hands to bow the plate enough to slide the front of the plate into the space between the cabinet top and the front panel trim (see Figure 1–2).
7. Move the front of the pouch as needed to line up the slots in the plate with the keys on the front panel.
8. Release the pressure on the plate to allow it to return to its normal flat shape.
9. Press down firmly to secure the Velcro strip to the top of the cabinet top.

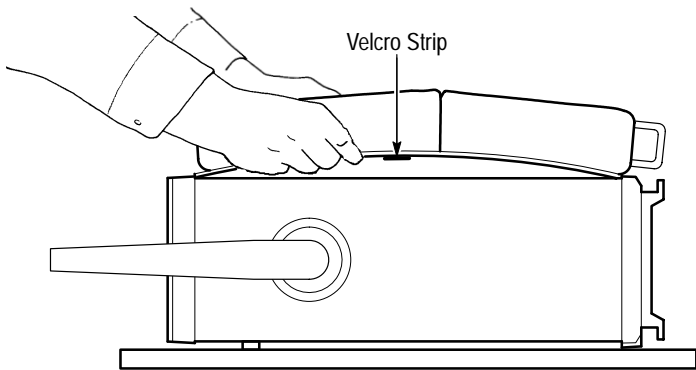

Figure 1-2: Inserting the Pouch Under the Front Panel Trim



CAUTION. Do not use the D-ring (see Figure 1–3) on the pouch plate to lift the CTS 710. Using the D-ring to lift the CTS 710 can pull the accessory pouch off the CTS 710, resulting in damage to the CTS 710.

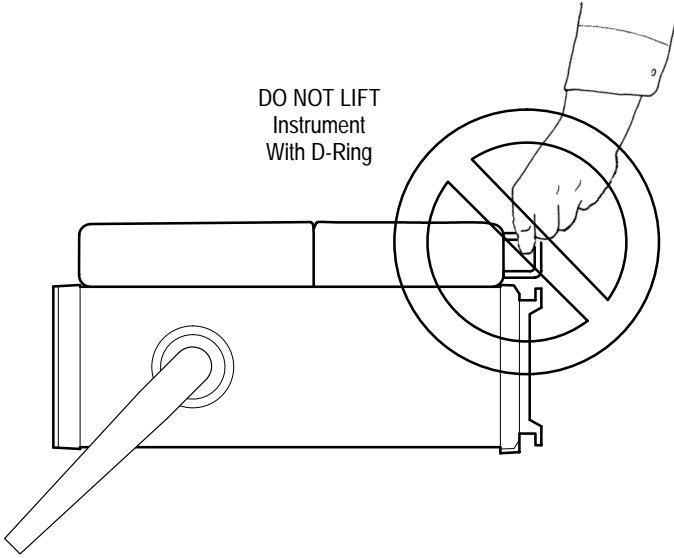

Figure 1-3: Location of the D-Ring on the Accessory Pouch

Setting Up the CTS 710

Before you use the CTS 710, ensure that it is properly set up and powered on.

To properly set up the CTS 710, do the following:

1. Be sure that the environment in which you will operate the CTS 710 is within instrument specifications. Specifications for temperature, relative humidity, altitude, vibrations, and emissions are included in *Appendix D*.
2. Leave space around the CTS 710 for cooling. Verify that the air intake and exhaust holes on the sides of the cabinet (where the fan operates) are free of any airflow obstructions. Leave at least 5 cm (2 in) free on each side.



WARNING. *To avoid electrical shock, be sure that the power cord is disconnected before checking the fuse.*

3. Check the fuse to be sure it is the proper type and rating (see Figure 1–4). The CTS 710 works with one of two fuses, depending on the AC supply. Each fuse requires its own cap (see Table 1–1). The CTS 710 is shipped with the UL-approved fuse installed.

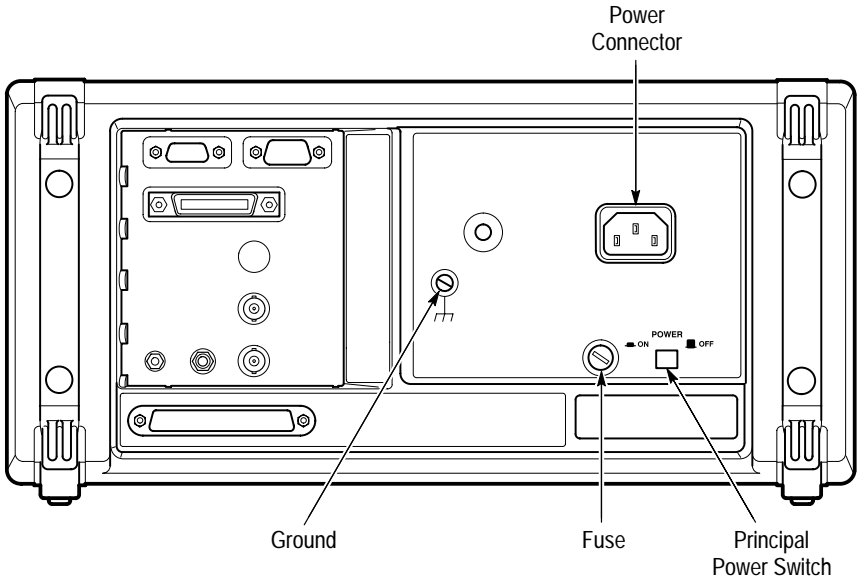

Figure 1-4: Rear-Panel Controls and Connectors Used in Setup

Table 1-1: Fuse and Fuse Cap Part Numbers

Fuse	Fuse Tektronix Part Number	Fuse Cap Tektronix Part Number
0.25 in × 1.25 in (UL 198.6, 3AG): 5 A FAST, 250 V	159-0014-XX	200-2264-XX
5 mm × 20 mm (IEC 127): 4 A, 250 V	159-0255-XX	200-2265-XX

4. Check that you have the proper electrical connections. The CTS 710 power requirements are listed in Table 1–2.

Table 1–2: Power Requirements

Voltage Range	Frequency Range	Maximum Power
90–132 V	48–62 Hz	250 W
180–250 V	48–62 Hz	250 W

5. Connect the proper power cord from the rear-panel power connector (see Figure 1–4) to the power system.

Turning On the CTS 710

To properly turn on the CTS 710:

1. Check that the rear-panel principal power switch is on. The principal power switch controls all AC power to the instrument.
2. If the CTS 710 is not turned on (the screen is blank), press the front-panel **ON/STBY** (On/Standby) button to turn it on (see Figure 1–5).

The ON/STBY button controls power to most instrument circuits. Power continues to go to certain parts even when this switch is set to STBY.

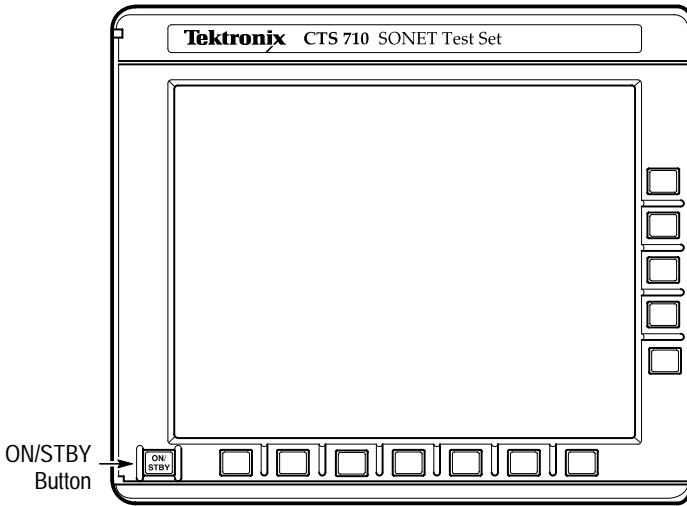

Figure 1-5: ON/STBY Button

The CTS 710 performs an internal self test each time it is turned on. When turned on, it displays a screen that states whether or not it passed the self test. (If the self test passes, the status display screen is removed after a few seconds.)

3. Check the self-test results.

If the self test fails, contact your local Tektronix Service Center for assistance.

Turning Off the CTS 710

Press the **ON/STBY** button to turn off the CTS 710.

Once the CTS 710 is in use, it is typical to leave the principal power switch on and use the ON/STBY button as the power switch. If the CTS 710 is frequently moved, use the principal power switch to turn the CTS 710 on and off.



Operating Basics



Functional Overview

This section describes how to use and navigate through the basic functions of the CTS 710, including:

- Controls, indicators, and connectors
- Elements of the display
- Menu structure
- On-line help
- Connecting signals
- Parameter selection and editing
- Disk drive operation

Front-Panel Controls, Indicators, and Connectors

Figures 2-1 and 2-2 identify the controls, indicators, and connectors located on the front panel of the CTS 710 SONET Test Set.

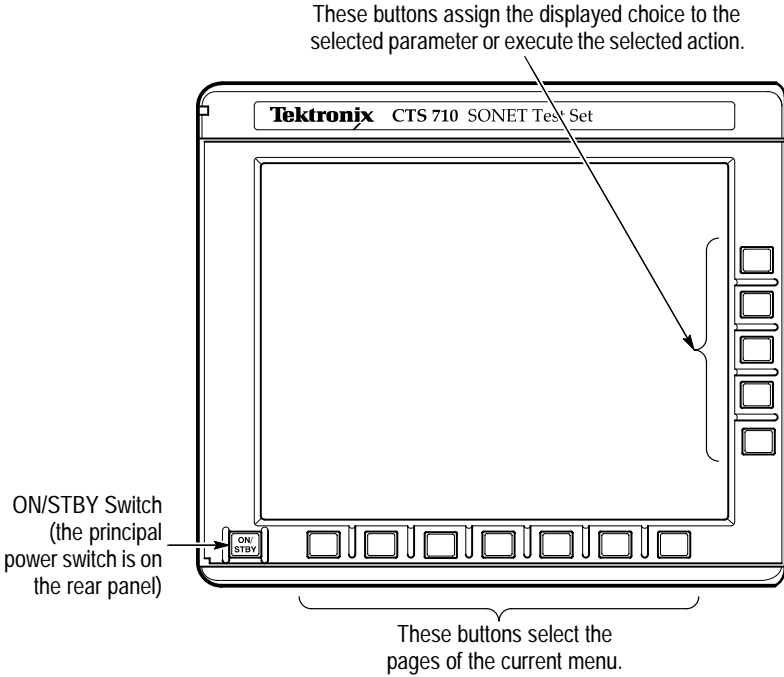

Figure 2-1: Controls Located Around the Display

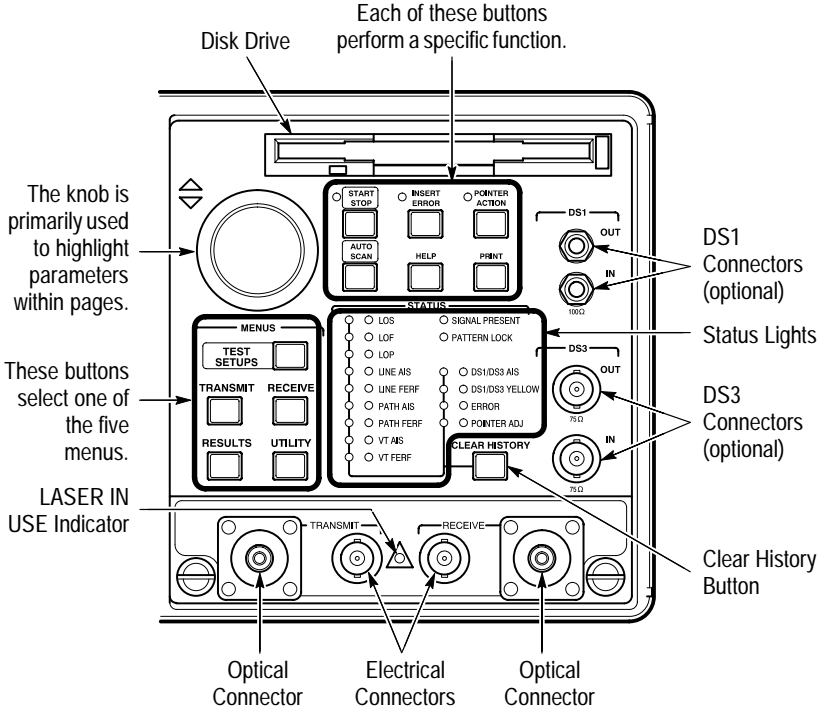

Figure 2-2: Front-Panel Controls, Indicators, and Connectors

Rear-Panel Controls and Connectors

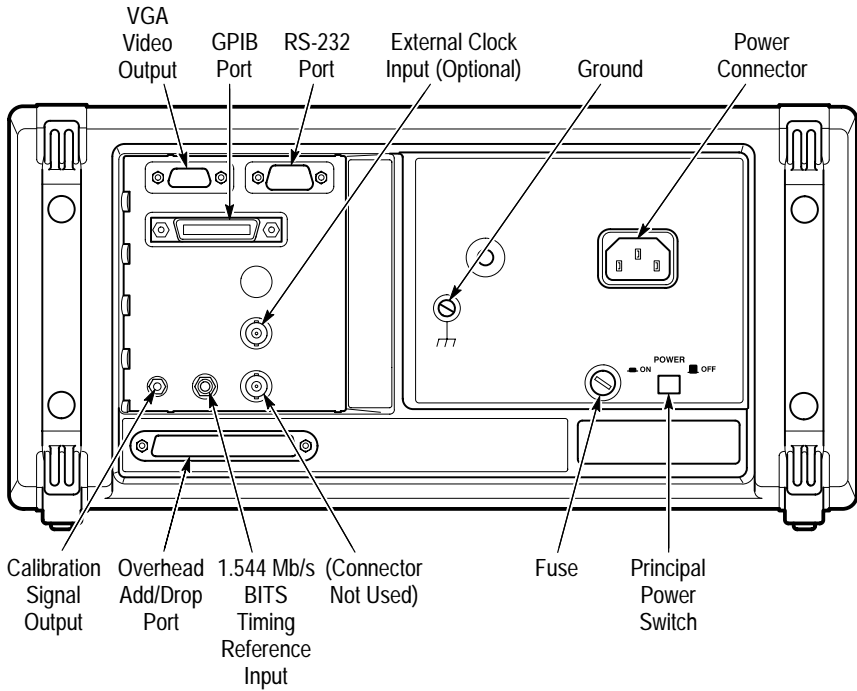

Figure 2-3: Rear-Panel Controls and Connectors

Front-Panel Status Lights

The status lights make it easy to quickly determine the condition of the received signal. There are three types of front-panel status lights.

- Green status lights. Green lights indicate whether a signal is present and whether the CTS 710 has locked onto the signal.
- Red status lights. When a red status light is on, it means that the indicated event is occurring. When the red light is off, no event is occurring.

- Yellow history lights.** Once an event has been detected, a yellow history light is turned on. The yellow history light shows that the associated event occurred at some time in the past. Yellow history lights remain on until you reset the event history by pressing the CLEAR HISTORY button, starting a new test, or changing the Receive Rate.

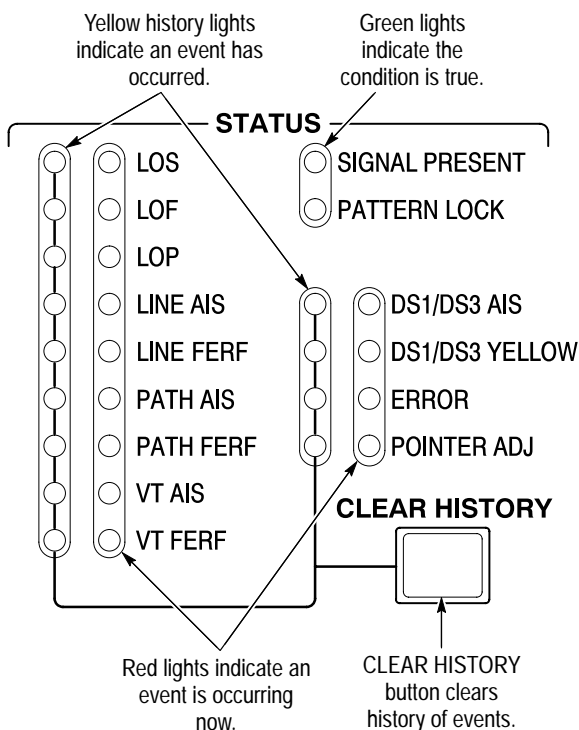

Figure 2-4: Status Lights (With Option 22 Installed)

Reading the Display

There are several major areas that make up the CTS 710 display (see Figure 2-5).

This area displays the contents of the different pages of each menu. Some pages display control parameters; some pages display test results.

The menu name appears here; the menu name is always visible.

Status message area. This area is always visible.

Signal Status Indicators

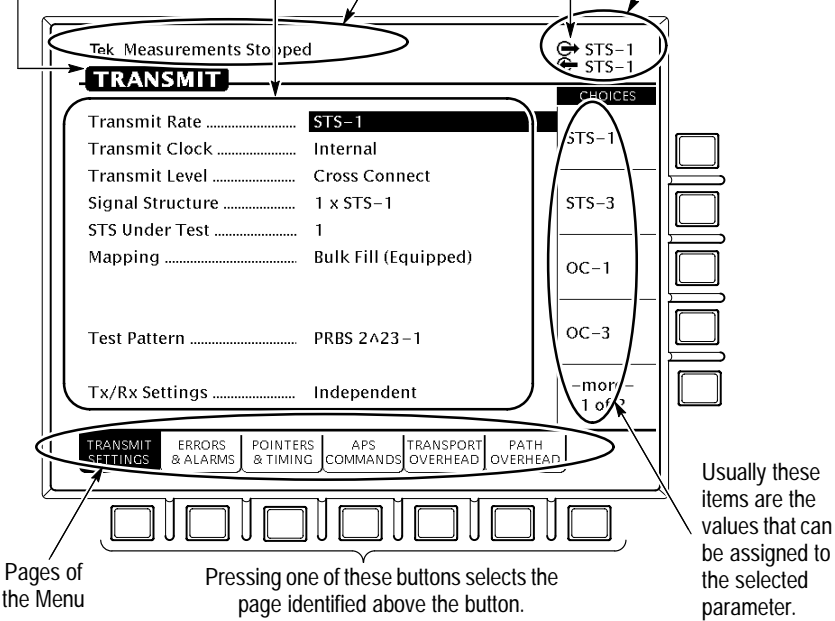

Figure 2-5: Major Areas of the Display

Figure 2–6 provides a guide to specific areas of the display.

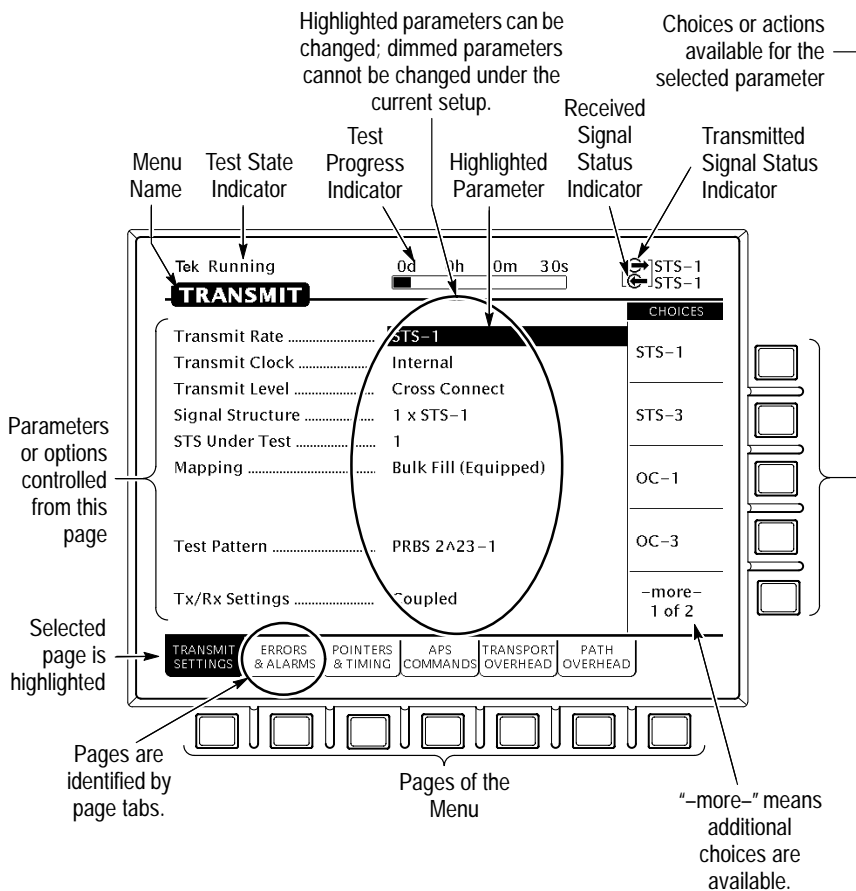













Figure 2–6: Specific Elements of the Display

Table 2–1 provides a list of icons that appear on the display. Icons are used to identify information, indicate instrument status, and clarify available actions.

Table 2-1: Icons that Appear in the Display

Icon	Meaning
	Transmitted signal
	Received signal
	CTS 710 is in through mode
	CTS 710 is in coupled mode
	Use the knob
	Not allowed
	File stored on disk
	File stored in memory
	Message or warning identifier
	Press the button to perform the indicated action
	The CTS 710 is busy

The Basic Menu Structure

The CTS 710 is controlled primarily through its menu system. Though several controls are located on the front panel, such as INSERT ERROR, most functions are controlled from one of the five menus. Figure 2-7 shows the five menus.

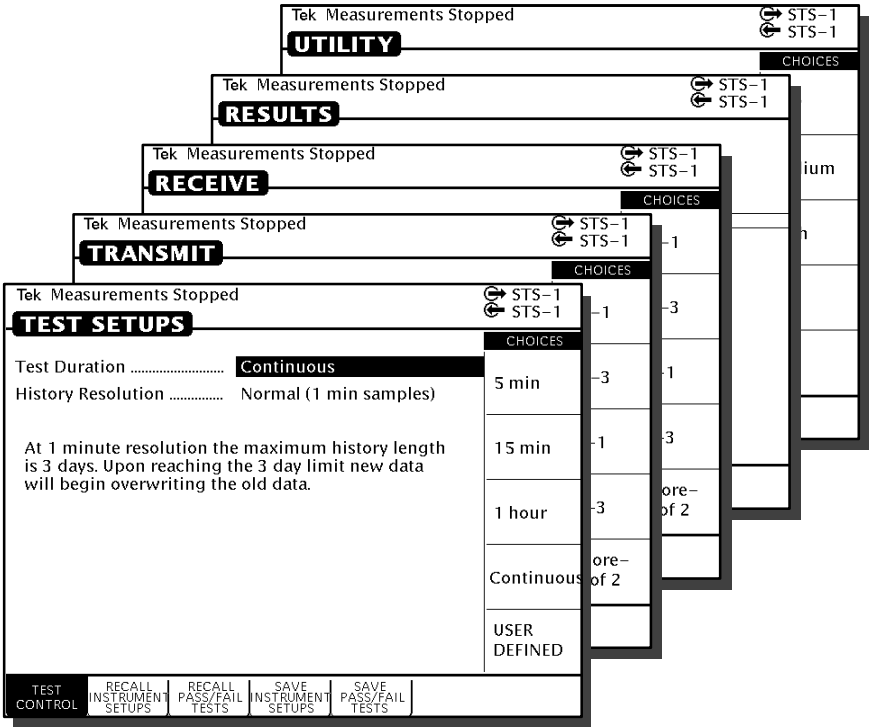

Figure 2-7: The Five Menus

What is a Menu?

A menu groups related functions together. For example, all settings that affect the signal transmitted by the CTS 710 are located in the TRANSMIT menu. Each menu is made up of pages. A page is

identified by a page tab located at the bottom of the display (see Figure 2–8).

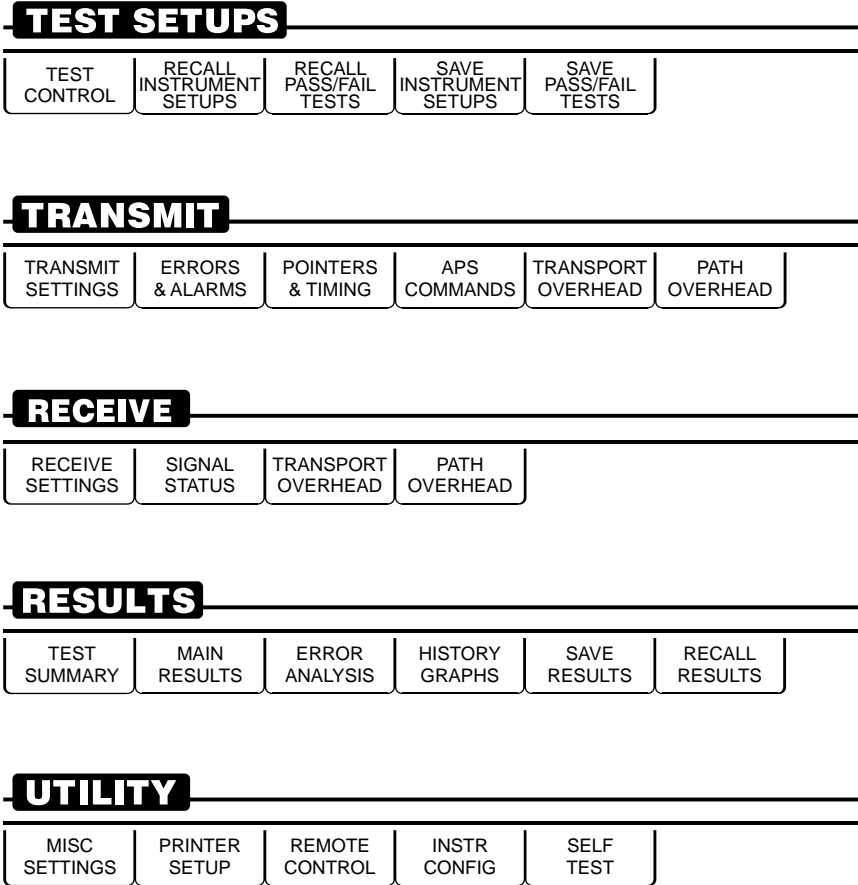

Figure 2–8: Menus and Pages

The CTS 710 always displays a menu. The name of the current menu is shown near the top of the display. To change to another menu, press a menu button on the front panel.

NOTE. The only times pressing a menu button does not change menus are when a dialog box is displayed or when you are entering a value for a parameter. You must first exit the dialog box or finish entering the value before you can change menus.

A page usually provides control over a related group of instrument functions or parameters. For example, the TRANSMIT SETTINGS page in the TRANSMIT menu controls the rate, format, and active channels of the signal transmitted by the CTS 710. However, some pages display information rather than provide control over settings; for example, the pages of the RESULTS menu display various test results.

Selecting Menus

To display a menu, press the button on the front panel with the same name (see Figure 2–9).

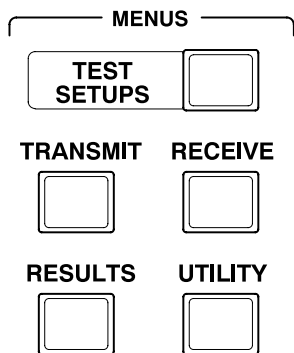

Figure 2–9: Menu Select Buttons

Selecting Pages

To select a page within a menu, press the button beneath the page tab located at the bottom of the display (see Figure 2–10).

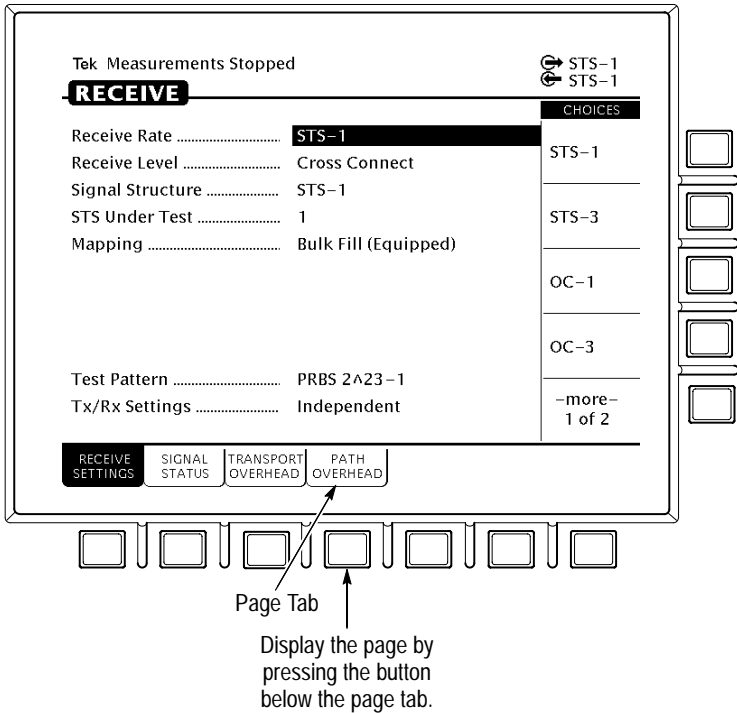

Figure 2-10: How to Display a Page

Displaying Help

To display help, press the **HELP** front-panel button.

When the HELP dialog box appears, use the knob to select the topic you wish to view (see Figure 2-11). After you select the topic to view, select **View Help** to see the help screen.

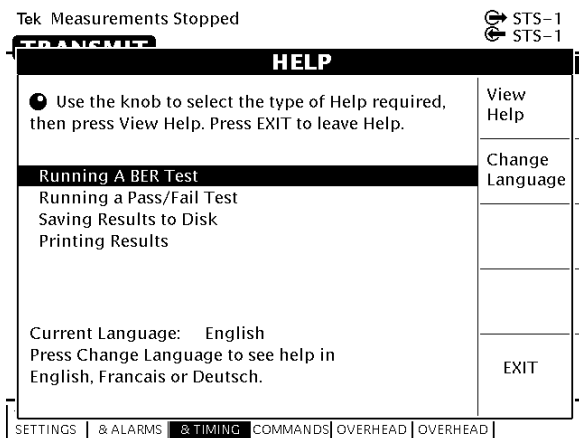

Figure 2–11: Help Dialog Box

Once you press View Help, the help screen for that topic is displayed. If a help topic covers more than one page, you can display the next page by selecting **Page Down**. To display the previous page, select **Page Up**.

To display help in a different language, select **Change Language**. Then, to display help in French, select **Francais**. To display help in German, select **Deutsch**.

When you finish reading the help text, you can exit the help dialog box by selecting **EXIT**. If you wish to read additional help topics, select **Help Menu** to return to the main help screen.

Connecting Signals

To connect signals to the CTS 710, use the electrical and optical connectors located at the bottom and right side of the front panel.

For optical connections, the CTS 710 accepts both single mode and multimode fiber. For electrical connections, the CTS 710 accepts 75 Ω coaxial cable with BNC connectors for SONET rates and DS3 signals. The CTS 710 accepts bantam connectors for DS1 signals.

Connecting Optical Signals

NOTE. *The optical TRANSMIT output is produced by a Class 1 laser device. The output from a Class 1 laser is safe to view without special eye protection. However, because other optical signals in your environment may exceed the Class 1 limits, we recommend eye protection as a precaution.*

To connect optical signals to the CTS 710:

1. Unscrew the dustcap that covers the optical port on the CTS 710.
2. Remove the dustcap (if present) covering the connector on the optical fiber.
3. Carefully insert the transmit end of the optical fiber into the **RECEIVE** port on the CTS 710. Line up the key on the optical fiber connector with the cutout on the optical port connector. Make sure that the optical fiber connector is fully inserted into the optical port.
4. Tighten the optical fiber connector so it does not accidentally come loose during use.
5. Carefully insert the receive end of the optical fiber into the **TRANSMIT** port on the CTS 710. Make sure that the optical fiber connector is fully inserted into the optical port.
6. Tighten the optical fiber connector so it does not accidentally come loose during use. Tighten the connectors only finger tight; do not use a tool to tighten the connectors.



CAUTION. *To prevent damage to the optical port connectors and to keep them clean, always replace the dustcaps on the optical port connectors when not using the optical ports.*

Connecting SONET Electrical Signals

To connect SONET electrical signals to the CTS 710:

1. Connect the transmit end of the signal cable to the **RECEIVE** connector on the CTS 710.
2. Connect the receive end of the signal cable to the **TRANSMIT** connector on the CTS 710.

Connecting DS1/DS3 Electrical Signals

To connect DS1/DS3 electrical signals to the CTS 710:

1. Connect the transmit end of the signal cable to the **IN** connector for the appropriate rate on the CTS 710.
2. Connect the receive end of the signal cable to the **OUT** connector for the appropriate rate on the CTS 710.

Initiating Autoscan

Autoscan is a feature that automatically scans the received signal and changes the CTS 710 receive settings to match the received signal. Autoscan is the quickest way to set up the CTS 710 to view a signal.

To initiate autoscan, press the **AUTOSCAN** front-panel button. For detailed information on the AUTOSCAN function, see *Checking Signal Status* on page 3–55.

Changing Parameters

Most of the menu pages in the CTS 710 contain parameters (or settings) that you can change. The choices available for a parameter appear in four ways (examples in parentheses):

- As a list (Test Pattern: PRBS 2²³–1, PRBS 2²⁰–1, ...)
- As a decimal number (Frequency Offset: 74.3 ppm)
- As a binary number (Z1 Byte: 10101111)
- As a text string (File Name: TEST_34)

Selecting Parameters

To change a parameter, use the knob to highlight it. As you turn the knob, the display highlight moves from parameter to parameter (see Figure 2–12).

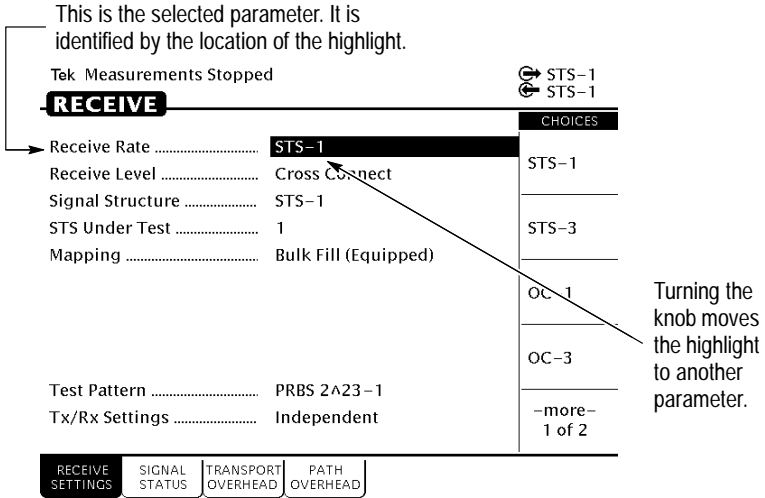

Figure 2–12: Selecting a Parameter

The parameter values displayed in high-intensity text indicate parameters that you can change. If a parameter is displayed in dimmed text, it cannot be selected under the current setup.

Selecting from Lists

Most parameters have a set group of choices available. The choices are presented as a list, located along the right side of the display. Press the button next to the choice to assign that choice to the highlighted parameter.

Sometimes parameters have more than five choices available. When more than five choices are available, the bottom choice changes to –more–. Selecting –more– displays additional choices. Each time

you press **more** the next list of choices is displayed. Below **more** is a line that shows which list of choices is displayed. When the last list of choices is displayed, pressing **more** displays the first list of choices again (see Figure 2-13).

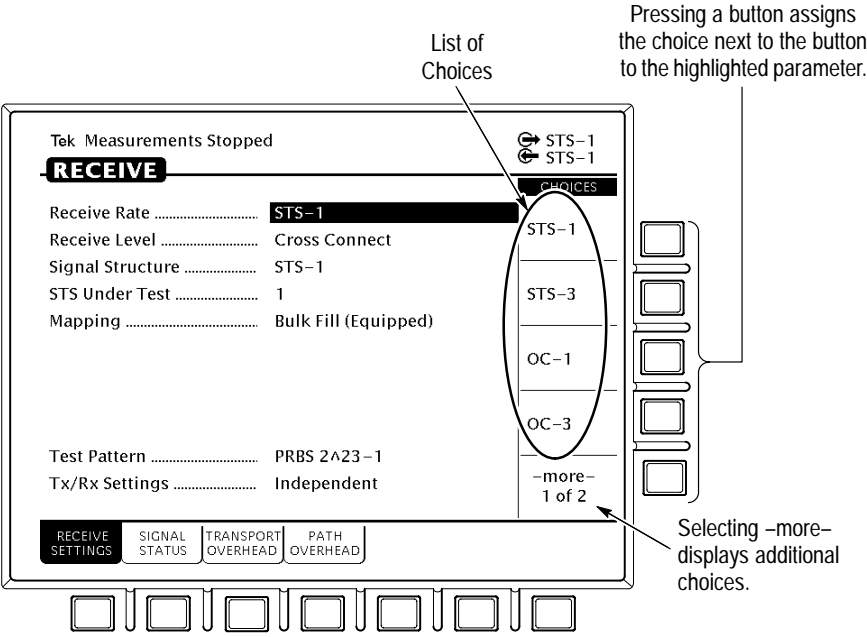

Figure 2-13: Selecting Choices From a List

Changing Decimal Numbers

Some parameters allow you to set a numeric value for them. For these parameters, preset choices are always provided to save you time. However, if the preset choices are not appropriate for your needs, you can set specific values by selecting the **USER DEFINED** choice (see Figure 2-14).

Tek Measurements Stopped

TRANSMIT

Pointer / Timing Mode	Pointer Movements	CHOICES
Pointer Type	STS Pointer	Min 0
Pointer Control	Set Value	Max 782
Pointer Value set to	522	Default 522
Set with New Data Flag	Yes	Illegal (Max+1)
Pointer S-Bits	00	USER DEFINED

STB-1
STB-1

← Selecting USER DEFINED allows you to enter a numeric value.

TRANSMIT SETTINGS | ERRORS & ALARMS | **POINTERS & TIMING** | APS COMMANDS | TRANSPORT OVERHEAD | PATH OVERHEAD

Figure 2-14: Selecting USER DEFINED

After you select USER DEFINED, the buttons at the right side of the display are reassigned, as shown in Figure 2-15.

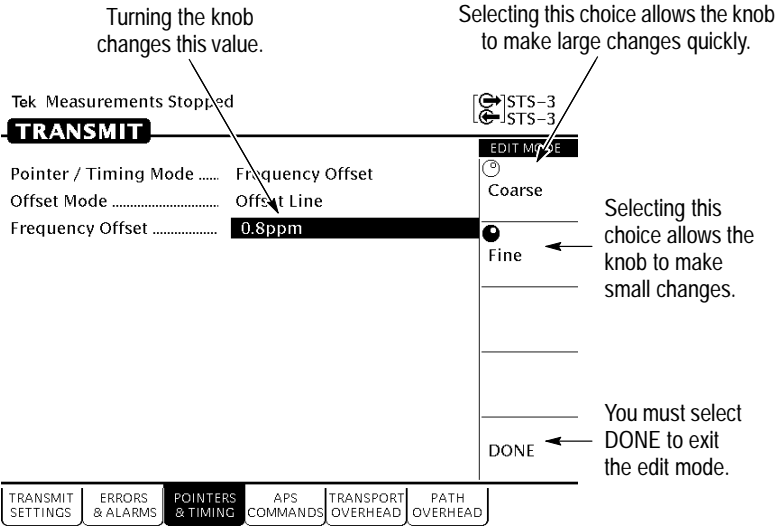

Figure 2–15: Entering a Numeric Value

After you press USER DEFINED, the CTS 710 enters edit mode. In edit mode, you change the value of the highlighted parameter by turning the knob. When you have set the parameter to the desired value, select **DONE** to enter the value and exit edit mode.

NOTE. The new value does not take effect until **DONE** is selected.

When in edit mode, the knob can work in several ways. As shown in Figure 2–15, the knob can be assigned to make either coarse or fine adjustments to the highlighted parameter. For other parameters, the knob is assigned to change different elements of the selected parameter. For example, when setting a test time, rather than making coarse or fine adjustments, the knob is assigned to change days, hours, minutes, or seconds.

The knob icon is displayed in solid form to indicate which function it is currently assigned to. The knob icon is displayed in outline form next to other possible choices.

Changing Binary Numbers

There are two kinds of binary numbers that can be changed in the CTS 710: payload patterns and overhead bytes. As with other numerical values, you can select preset values or enter specific values by selecting Edit Byte.

To change a byte:

1. Select the byte with the knob (see Figure 2–16).
2. Change the byte by selecting one of the preset choices at the right side of the display or to enter a different bit pattern, select **EDIT BYTE**. This places the CTS 710 into edit mode.

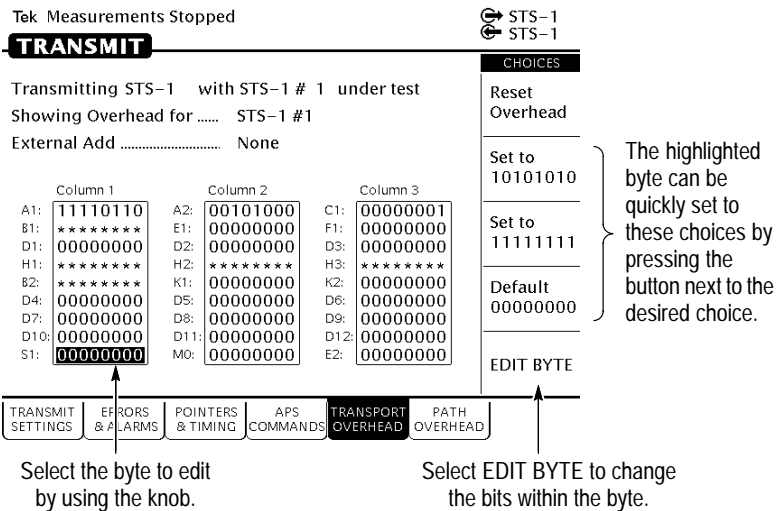

Figure 2–16: Selecting a Byte for Editing

When in edit mode, the choices along the right side of the display change (see Figure 2–17). The highlight now applies to a single bit.

- 3. To change the value of the highlighted bit, select either **1** or **0**. Each time you select 1 or 0, the highlighted bit is changed and the highlight moves to the next bit.
- 4. To select a different bit for editing, select either the right or left arrow to move the highlight. When the desired bit is highlighted, select either **1** or **0**.
- 5. When you are finished editing the byte, select **DONE**. This enters the changes to the byte and exits edit mode.

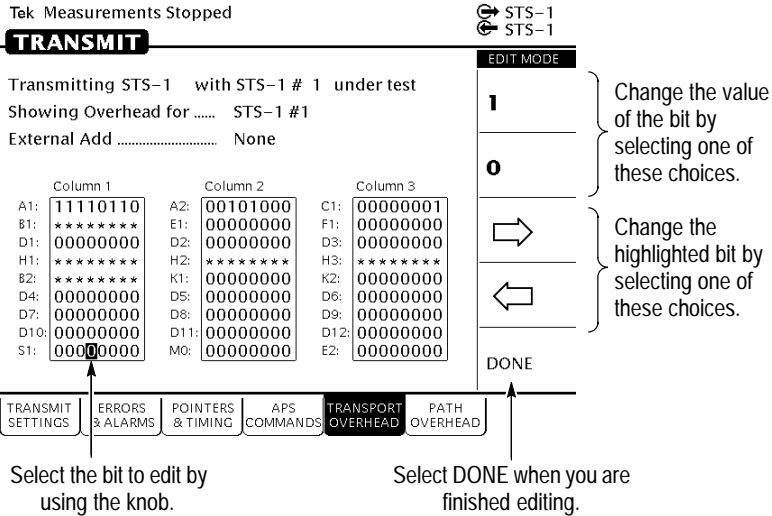

Figure 2-17: Editing a Byte

Entering Text

Several parameters, such as file names, operator prompts, and path trace messages, consist of text strings. You can set text strings to preset choices or enter your own text string. When you highlight a text parameter using the knob, the choices at the right side of the display change to present predefined text strings (if appropriate) and the option to edit the text string (see Figure 2-18).

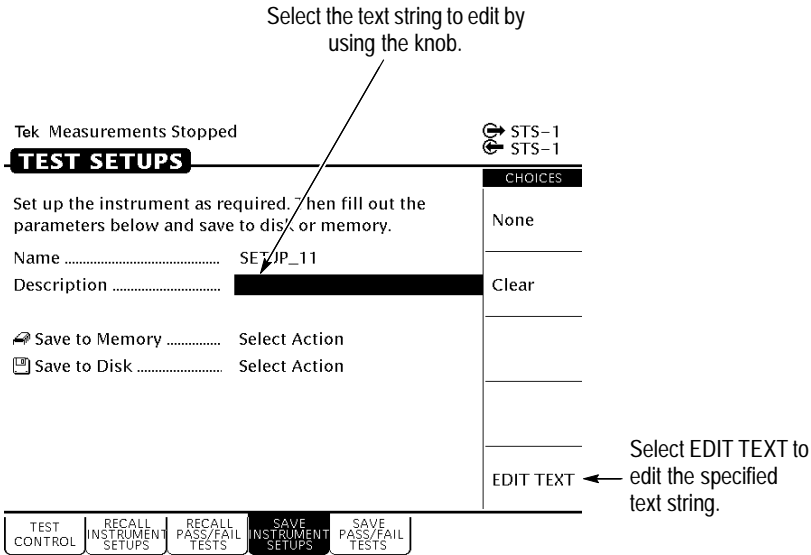

Figure 2–18: Selecting a Text String for Editing

To edit a text string:

1. Select the text string by turning the knob until the desired text string is highlighted (see Figure 2–18).
2. Select **EDIT TEXT**. This places the CTS 710 into edit mode.

When in edit mode, the choices along the right side of the display change (see Figure 2–19). In edit mode, the status line at the top of the display is replaced with a line that displays the characters available for placing into the text string. (Some characters available for message text are not available for file names.)

3. To change the highlighted character or enter a new one, select the character to enter by turning the knob.
4. To enter the selected character, select **Enter <character>**.

To delete a character already entered, use the arrows to highlight the character. Select **Delete** to delete the character.

5. When you are finished editing the text string, select **DONE**.

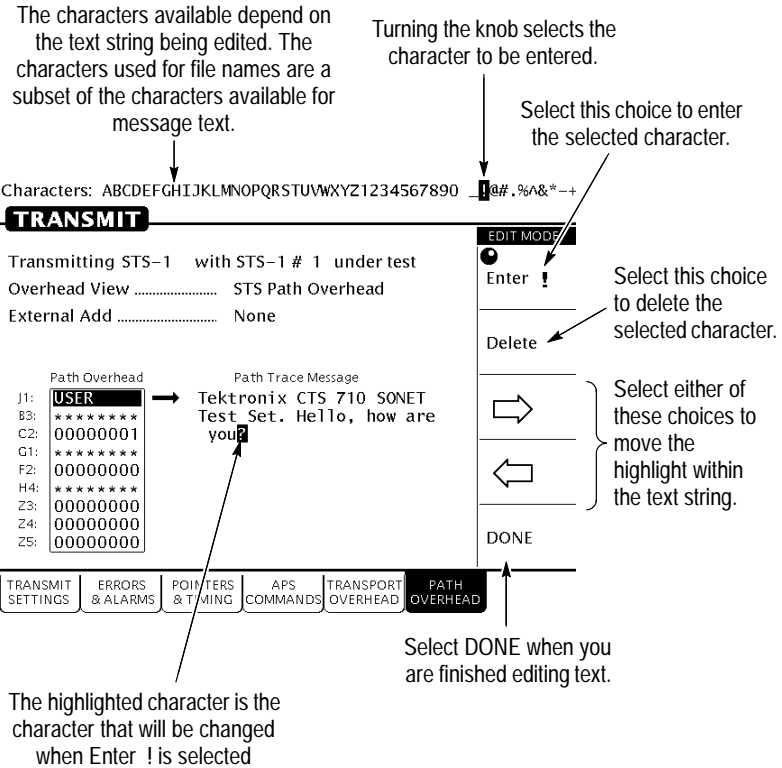

Figure 2-19: Editing a Text String

Working with the Disk Drive

Use the disk drive in the CTS 710 to save instrument setups, pass/fail tests, measurement results and measurement histories. The CTS 710 reads disks formatted in MS-DOS format. It reads only 1.44 MB disks. The CTS 710 does not format disks. Files written to disk consist of four types, as shown in Table 2-2.

Table 2-2: CTS 710 Disk File Types

File Type	Description	File Extension
Instrument Setups	Complete description of instrument settings	.SET
Pass/Fail Tests	Complete description of instrument settings, operator prompts, and Fail If conditions	.TST
Measurement Results ¹	An ASCII file listing the results of a test	.RES
Measurement History ¹	Binary file containing the history of test results	.HIS

¹ **The CTS 710 creates two files (with extensions .RES and .HIS) when you save test results.**

The CTS 710 displays only file names with the extensions shown in Table 2-2. Disk files with any other extensions do not appear in file name displays.

Reading Files on Disk

You can display disk file names in three places: the **RECALL INSTRUMENT SETUPS** page and the **RECALL PASS/FAIL TESTS** page of the **TEST SETUPS** menu, and the **RECALL RESULTS** page of the **RESULTS** menu.

To view instrument setups files on a disk:

1. Insert the disk into the disk drive.
2. Press the **TEST SETUPS** front-panel button to display the **TEST SETUPS** menu.
3. Select the **RECALL INSTRUMENT SETUPS** page.
4. Select **Disk** to display the instrument setups on disk.

To view pass/fail files on a disk:

1. Insert the disk into the disk drive.

2. Press the **TEST SETUPS** front-panel button to display the TEST SETUPS menu.
3. Select the **RECALL PASS/FAIL TESTS** page.
4. Select **Disk** to display the pass/fail tests on disk.

To view test results files on a disk:

1. Insert the disk into the disk drive.
2. Press the **RESULTS** front-panel button to display the RESULTS menu.
3. Select the **RECALL RESULTS** page.
4. Select **Disk** to display the test results files on disk.

***NOTE.** Disk operations may take several seconds if there are many files on the disk. The light on the front of the disk drive turns off when the disk operation is complete.*

Tutorial

The tutorial acquaints you with the features of the CTS 710 by having you run a test while you explore specific features of the CTS 710. For full details on how to use the CTS 710, refer to *Reference*.

The tutorial presents procedures in tables. Perform the procedure by reading from left to right in the table (see example below). The word *none* in a cell indicates that no action is required.

Press Menu Button	Select Menu Page	Highlight Parameter	Select Choice
Begin here with Step 1	Step 2	Step 3	Step 4
		Step 5	Step 6
		Step 7	Step 8, CTS 710 instruction is complete

Some procedures require several iterations of highlighting parameters and selecting choices. Some procedures may require more than one menu button or menu page selection as well.

Before Turning On the CTS 710

This tutorial describes how to perform a bit-error rate (BER) test on an STS-1 signal. To perform the tutorial, you need a 75 Ω coaxial cable with BNC connectors on each end. This tutorial assumes you have set up the CTS 710 as described in *First Time Operation*, on page 1–3.

To set up your CTS 710 for the tutorial, perform these steps:

- Check that the CTS 710 is turned off. If it is on, you can put it in standby mode by pressing the **ON/STBY** button.

Connect the coaxial cable between the **TRANSMIT** and **RECEIVE** BNC connectors on the front panel (see Figure 2–20).

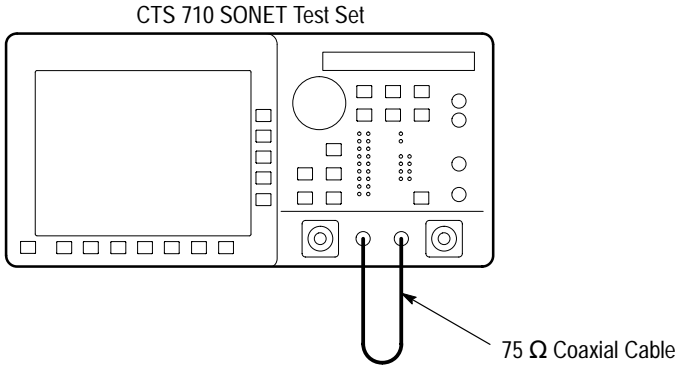

Figure 2–20: Setup for the Tutorial

Press the **ON/STBY** button to turn on the CTS 710.

The CTS 710 performs its power-on self test and then displays the **TRANSMIT** menu.

Before proceeding with the tutorial, initialize the CTS 710 as follows:

Press Menu Button	Select Menu Page	Highlight Parameter	Select Choice
TEST SETUPS	RECALL INSTRUMENT SETUPS	DEFAULT FACTORY SETTINGS	Recall Setup

Setting Transmit Parameters

Before beginning the BER test, set the transmit and receive parameters.

To set the transmit and receive parameters:

Press Menu Button	Select Menu Page	Highlight Parameter	Select Choice
TRANSMIT	TRANSMIT SETTINGS	Transmit Rate (see Figure 2-21)	STS-3

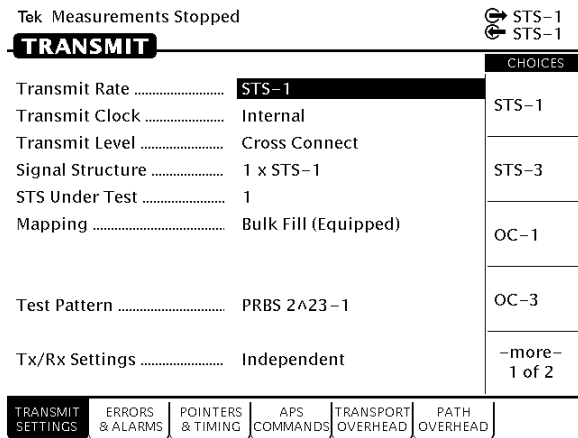

Figure 2-21: The TRANSMIT SETTINGS Page of the TRANSMIT Menu

Note that as soon as you changed the transmit rate that the red ERROR light on the front panel came on and the red LOS, LOF, and LOP status lights came on (also, NO SIG appeared next to the incoming-signal icon at the top of the display). The lights turned on because you can set the transmit and receive settings independently and right now the receive section is still set to STS-1. You will change the receive rate later in this tutorial.

An STS-3 signal is made up of three STS-1 signals. The CTS 710 can test only one signal at a time; therefore, you must specify which of the three signals that make up the STS-3 signal you wish to test. This tutorial has you test the second signal. The signal to be tested is identified on the STS Under Test line.

To specify which signal, or STS, to test:

Press Menu Button	Select Menu Page	Highlight Parameter	Select Choice
		STS Under Test	2

To set the mapping and the test pattern:

Press Menu Button	Select Menu Page	Highlight Parameter	Select Choice
		Mapping	No Mapping (Equipped)
		Test Pattern	PRBS 2^20-1

Setting Receive Parameters

You can set receive parameters two ways. The first way is to set the parameters individually: display the RECEIVE menu and set each parameter manually on the RECEIVE SETTINGS page. The second way is to couple the receive settings to the transmit settings. To do this, use the Tx/Rx Settings line on the TRANSMIT SETTINGS page. (The Tx/Rx Settings line appears on both the TRANSMIT SETTINGS page and the RECEIVE SETTINGS page. To couple transmit settings to the receive settings, you would use the Tx/Rx Settings line on the RECEIVE SETTINGS page.)

To couple the receive settings to the transmit settings:

Press Menu Button	Select Menu Page	Highlight Parameter	Select Choice
TRANSMIT	TRANSMIT SETTINGS	Tx/Rx Settings	Coupled

As soon as you select Coupled, the red error light turns off and the icon in the status area changes to indicate the Tx/Rx Settings are

coupled. However, note that the yellow history light remains on as an indication that an error has occurred.

Press **CLEAR HISTORY** to clear the error history light.

When the Tx/Rx Settings parameter is set to Coupled, all parameter settings on the RECEIVE SETTINGS page transfer to the TRANSMIT SETTINGS page. Thereafter, any change to either page affects both pages as long as Tx/Rx Settings is set to Coupled.

Setting the Test Time

Before beginning the BER test, you must specify the duration of the test.

To set the duration of the test:

Press Menu Button	Select Menu Page	Highlight Parameter	Select Choice
TEST SETUPS (see Figure 2-22)	TEST CONTROL	Test Duration	15 min

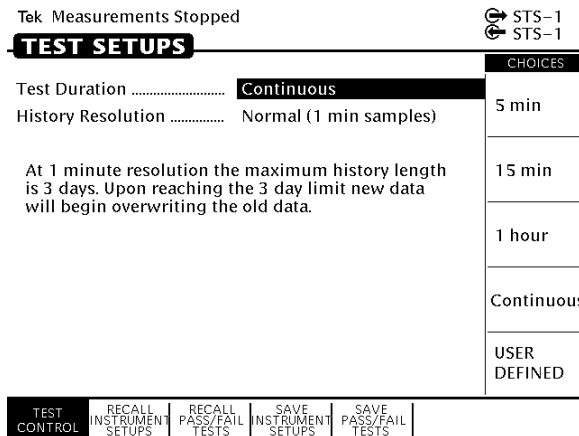

Figure 2-22: The TEST CONTROL Page of the UTILITY Menu

Where Test Results Are Displayed

Once you have set the transmit and receive parameters and the test time, you can begin the test. However, before starting the test, look at the RESULTS menu where the results of the test appear.

To display the RESULTS menu:

Press Menu Button	Select Menu Page	Highlight Parameter	Select Choice
RESULTS	<i>none</i>	<i>none</i>	<i>none</i>

The TEST SUMMARY page contains a summary of the current or most recent test (see Figure 2–23). Just below the menu name is information about the current or most recent test. If the test detected no alarms or errors, the CTS 710 displays the message No Alarms No Errors.

Tek Measurements Stopped ↻ STS-3
↻ STS-3

RESULTS

Results Source: ↻ Current Results
 Results Rate: STS-3
 Results Mapping: Equipped
 Test Started: 20:40:00 16-Jul-95
 Elapsed Time: 0d 0h 0m

TROUBLE SCAN

No Alarms No Errors

TEST SUMMARY	MAIN RESULTS	ERROR ANALYSIS	HISTORY GRAPHS	SAVE RESULTS	RECALL RESULTS
--------------	--------------	----------------	----------------	--------------	----------------

Figure 2–23: The TEST SUMMARY Page of the RESULTS Menu

The RESULTS menu contains four pages on which results are displayed: TEST SUMMARY, MAIN RESULTS, ERROR ANALYSIS, and HISTORY GRAPHS. Select **MAIN RESULTS** to see one way test results are displayed (see Figure 2–24).

Tek Measurements Stopped				STB-3	STB-3
RESULTS				CHOICES	
Errors	ERROR COUNTS	ERROR RATIOS	ERRORED SECONDS	Errors	
Section B1 BIP	0	0.00	0	Failures	
Line B2 BIP	0	0.00	0		
Path B3 BIP	0	0.00	0		
Pattern Bit	0	0.00	0	Alarms	
Line FEBE	0	0.00	0	Pointers	
Path FEBE	0	0.00	0		

TEST SUMMARY	MAIN RESULTS	ERROR ANALYSIS	HISTORY GRAPHS	SAVE RESULTS	RECALL RESULTS
--------------	---------------------	----------------	----------------	--------------	----------------

Figure 2–24: The MAIN RESULTS Page of the RESULTS Menu

The MAIN RESULTS page contains a listing of the different errors that can occur. Since you have not started your test yet, the values are those of the last test run. To continue with the test setup, select TEST SUMMARY.

Begin the Test

Note at the top of the display the message Measurements Stopped. When you start the test, this message will change. To start the test, press the front-panel **START/STOP** button.

Once a test starts, the display changes in two ways. First, the message Running appears at the top of the display (see Figure 2–25). This message line is always visible so you know that a test is running, even if a page is displayed that doesn't contain any information about tests. Second, the test status indicator appears.

There are two elements to the test status indicator. The text above the bar graph indicates how long the test has been running. The text lists the days, hours, minutes, and seconds the test has been running. The bar graph indicates what percentage of the test is complete (except when the test duration is set to continuous).

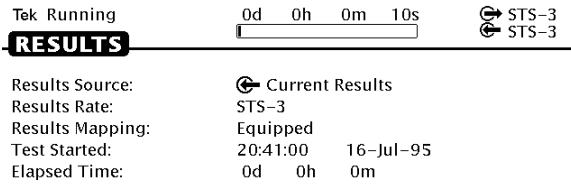

TROUBLE SCAN
No Alarms No Errors

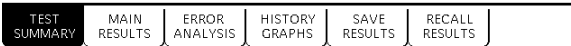

Figure 2-25: The Message Line and Test Status Indicator

Inserting Errors

Now that the test is running, you will insert some errors and see how the CTS 710 responds. To set the error insertion parameters, first display the ERRORS & ALARMS page as follows:

Press Menu Button	Select Menu Page	Highlight Parameter	Select Choice
TRANSMIT	ERRORS & ALARMS (see Figure 2-26)	<i>none</i>	<i>none</i>

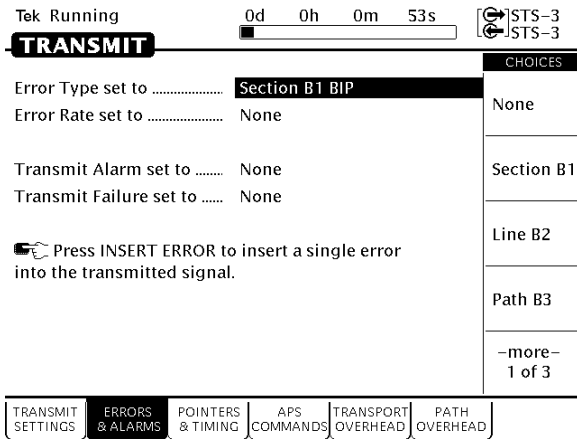

Figure 2–26: The ERRORS & ALARMS Page of the TRANSMIT Menu

There are two ways to insert errors into the transmitted signal. You can insert errors one at a time or you can set a rate at which the CTS 710 inserts errors automatically. Before inserting errors, you must specify the type of error to be inserted. You specify the type of error to be inserted with the Error type set to parameter.

To set the type of error to insert:

Press Menu Button	Select Menu Page	Highlight Parameter	Select Choice
		Error type set to	Path B3 BIP

The rate at which errors are inserted is specified on the Error rate set to line. An error rate of None specifies that no errors are inserted unless the INSERT ERROR button is pressed. Any error rate other

than None results in a continuous stream of errors being inserted into the transmitted signal.

To insert a single error, press **INSERT ERROR**.

When you press the INSERT ERROR button the red ERROR light flashes.

To insert a continuous stream of errors:

Press Menu Button	Select Menu Page	Highlight Parameter	Select Choice
		Error rate set to	1.0E-5

Note that the red ERROR light now stays on all the time; errors are being detected continually.

To turn off the automatic error insertion:

Press Menu Button	Select Menu Page	Highlight Parameter	Select Choice
TRANSMIT	ERRORS & ALARMS	Error Rate set to	None

Now that errors are no longer being transmitted, the red ERROR light has gone out, although the yellow history light is still on. To clear the error history, press **CLEAR HISTORY**.

Adjusting Pointers

The CTS 710 enables you to adjust or move pointers. Note that pointer movements are not necessarily errors. Pointer parameters are set on the POINTERS & TIMING page of the TRANSMIT menu.

To display the POINTERS & TIMING page:

Press Menu Button	Select Menu Page	Highlight Parameter	Select Choice
TRANSMIT	POINTERS & TIMING (see Figure 2-27)	<i>none</i>	<i>none</i>

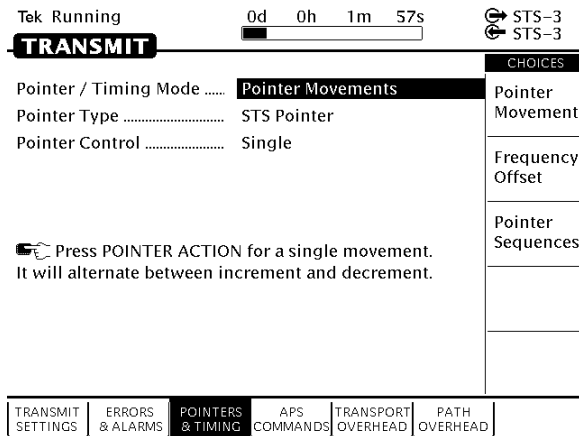

Figure 2-27: The POINTERS & TIMING Page of the TRANSMIT Menu

Before adjusting a pointer, you must decide what mode of pointer movement to use. You can change a pointer by adjusting the pointer directly or by using frequency offset. The default mode is Pointer Movements, which allows you to adjust pointers directly.

To specify how the pointer will be adjusted:

Press Menu Button	Select Menu Page	Highlight Parameter	Select Choice
		Pointer Control	Single

After selecting Single for pointer control, a message displays that tells you how to adjust the pointer. Pointer movement alternates between increment and decrement.

To adjust a pointer, press the front-panel **POINTER ACTION** button.

Each time you press **POINTER ACTION**, a pointer adjusts and the **POINTER ACTION** light turns on. Also, a message appears at the top of the display that describes the type of pointer movement that occurs. On this page you can also adjust frequency offset which may cause a network element to generate pointer movements.

To see the pointer value changing:

Press Menu Button	Select Menu Page	Highlight Parameter	Select Choice
RESULTS	MAIN RESULTS	<i>none</i>	Pointers

Now press **POINTER ACTION** again.

To adjust a pointer using frequency offset:

Press Menu Button	Select Menu Page	Highlight Parameter	Select Choice
TRANSMIT	POINTERS & TIMING	Pointer / Timing Mode	Frequency Offset

After selecting Frequency Offset, note that the available parameters change. When in Frequency Offset mode, the only parameters that can be set are Offset Mode and Frequency Offset.

To change the frequency offset of the signal:

Press Menu Button	Select Menu Page	Highlight Parameter	Select Choice
		Frequency Offset	Stress +4.6ppm

If the preset choices do not match what you need, use USER DEFINED to define an alternative.

To define a specific frequency offset:

Press Menu Button	Select Menu Page	Highlight Parameter	Select Choice
			USER DEFINED

When you select USER DEFINED, the knob is assigned to adjust the frequency offset. Two choices are available in this mode: Coarse and Fine (see Figure 2–28). Coarse adjusts the frequency offset by 10 ppm. Fine adjusts the frequency offset by 0.1 ppm. The larger the value for frequency offset, the more often the pointer is adjusted.

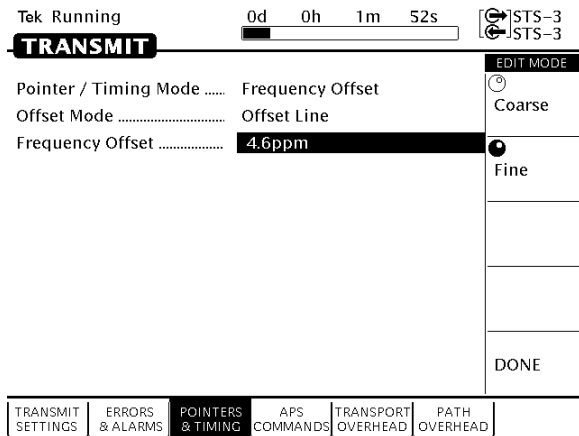

Figure 2–28: Adjusting Frequency Offset Using the Knob

Use the knob to change the value of Frequency Offset; select any value you wish. When you are finished selecting a frequency offset:

Press Menu Button	Select Menu Page	Highlight Parameter	Select Choice
			DONE

To turn off frequency offset:

Press Menu Button	Select Menu Page	Highlight Parameter	Select Choice
TRANSMIT	POINTERS & TIMING	Frequency Offset	Default Oppm

Selecting Default Oppm sets the Frequency Offset back to 0 ppm.

Viewing Transport Overhead

The CTS 710 allows you to view the transport overhead for the transmitted or received signal. To view the transport overhead for the transmitted signal:

Press Menu Button	Select Menu Page	Highlight Parameter	Select Choice
TRANSMIT	TRANSPORT OVERHEAD	<i>none</i>	<i>none</i>

The first line of text under the menu name describes the signal being received and the STS under test (see Figure 2–29).

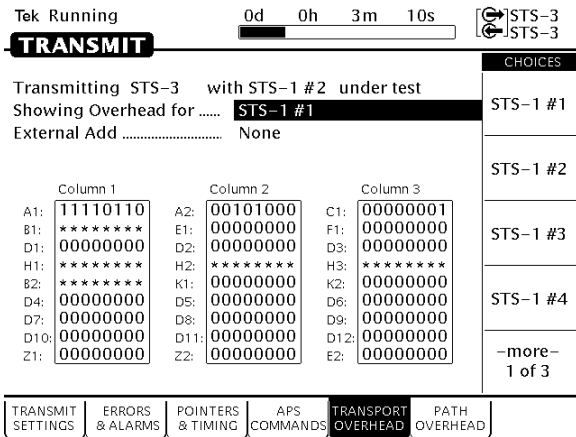

Figure 2-29: The TRANSPORT OVERHEAD Page of the TRANSMIT Menu

The Showing Overhead for parameter identifies which columns of the transport overhead are displayed. To display the overhead for other SPEs within the signal, select the appropriate choice.

Press Menu Button	Select Menu Page	Highlight Parameter	Select Choice
		Showing Overhead for	STS-1 #1

Editing the Transport Overhead

Except for certain reserved bytes, you can edit the bytes of the transport overhead of the transmitted signal. Reserved bytes are identified by asterisks (*) in the byte content area of the displayed column.

To edit a byte of the transport overhead:

Press Menu Button	Select Menu Page	Highlight Parameter	Select Choice
		S1 byte	EDIT BYTE

Once you have selected EDIT BYTE, the CTS 710 enters the edit mode (see Figure 2–30).

Tek Running 0d 0h 3m 27s STS-1 STS-1

TRANSMIT **EDIT MODE**

Transmitting STS-1 with STS-1 # 1 under test
 Showing Overhead for STS-1 #1
 External Add None

Column 1	Column 2	Column 3
A1: 11110110	A2: 00101000	C1: 00000001
B1: *****	E1: 00000000	F1: 00000000
D1: 00000000	D2: 00000000	D3: 00000000
H1: *****	H2: *****	H3: *****
B2: *****	K1: 00000000	K2: 00000000
D4: 00000000	D5: 00000000	D6: 00000000
D7: 00000000	D8: 00000000	D9: 00000000
D10: 00000000	D11: 00000000	D12: 00000000
S1: 00000000	M0: 00000000	E2: 00000000

1
0
→
←
DONE

TRANSMIT SETTINGS ERRORS & ALARMS POINTERS & TIMING APS COMMANDS **TRANSPORT OVERHEAD** PATH OVERHEAD

Figure 2–30: The Display in Edit Mode

To change the value of any bit within the byte, highlight the bit you wish to change. To change the value of the highlighted bit, select either 1 or 0. After you assign a value to the highlighted bit, the highlight moves to the next bit to be edited.

Edit the S1 byte to read **10101010**.

Select **DONE** when you have finished editing the byte.

You can assign preset values to the highlighted byte. For example, rather than editing each bit of the byte as you just did, you could also

have selected Set to 10101010. To see that the CTS 710 is now receiving the new value of the S1 byte:

Press Menu Button	Select Menu Page	Highlight Parameter	Select Choice
RECEIVE	TRANSPORT OVERHEAD	<i>none</i>	<i>none</i>

Verify that the transport overhead for STS-1 #1 is displayed. If it is not:

Press Menu Button	Select Menu Page	Highlight Parameter	Select Choice
		Showing Overhead for	STS-1 #1

Look at the value of the S1 byte. You will see that it is 10101010, as previously set.

Viewing Test Results

The test has been running for several minutes and errors have been transmitted. To see the test results, you must display the RESULTS menu. To display the RESULTS menu:

Press Menu Button	Select Menu Page	Highlight Parameter	Select Choice
RESULTS	TEST SUMMARY	<i>none</i>	<i>none</i>

The TEST SUMMARY page identifies the most common errors that the CTS 710 has detected. You will see a line that identifies the worst error rate detected and may find listings for other types of errors (see Figure 2-31).

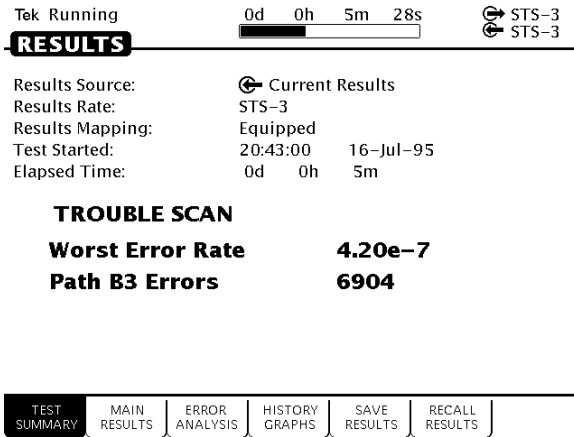

Figure 2-31: The TEST SUMMARY Page of the RESULTS Menu

The MAIN RESULTS page displays all the errors that have been detected. It also displays the error ratio and the number of errored seconds that have been logged (see Figure 2-32).

To display the MAIN RESULTS page:

Press Menu Button	Select Menu Page	Highlight Parameter	Select Choice
	MAIN RESULTS	<i>none</i>	<i>none</i>

Tek Running 0d 0h 6m 30s ↻ STS-3
↻ STS-3

RESULTS

Errors	ERROR	ERROR	ERRORED	CHOICES
	COUNTS	RATIOS	SECONDS	
Section B1 BIP	0	0.00	0	Errors
Line B2 BIP	0	0.00	0	Failures
Path B3 BIP	6904	3.53e-7	14	
Pattern Bit	0	0.00	0	Alarms
Line FEBE	0	0.00	0	Pointers
Path FEBE	0	0.00	0	

TEST SUMMARY | **MAIN RESULTS** | ERROR ANALYSIS | HISTORY GRAPHS | SAVE RESULTS | RECALL RESULTS

Figure 2-32: The MAIN RESULTS Page of the RESULTS Menu

This completes the tutorial. For detailed information on CTS 710 capabilities, refer to *Reference*, starting on page 3-1.



Reference

Basic Test Procedures

This section gives examples of how to set up and use the CTS 710 SONET Test Set for several common telecommunication network applications:

- Network continuity checking
- Transmission signal quality testing
- Fault tolerance testing
- Performance monitoring

Setting Up the CTS 710

This section presents setup instructions for the CTS 710 in tables. Perform the steps reading from left to right in the table (see example below). The word *none* in a cell indicates that no action is required.

Press Menu Button	Select Menu Page	Highlight Parameter	Select Choice
Begin here with Step 1	Step 2	Step 3	Step 4
		Step 5	Step 6
		Step 7	Step 8, CTS 710 Setup is complete

Menu buttons are located on the instrument front panel. Select menu pages with the buttons below the display. Use the knob to highlight a parameter; then use the buttons at the right to select a choice. Many setups require several iterations of highlighting parameters and selecting choices. Some setups may require more than one menu button or menu page selection as well.

The first step in each application setup initializes the CTS 710 to a known state.

Network Continuity Checking

With the AUTOSCAN feature of the CTS 710, it is easy to make a quick continuity check. The continuity check verifies that a SONET network element (NE), or portion of the network, is correctly set up and provisioned and that the signal passes through intact. In this example, the CTS 710 transmits an STS-3 signal into an NE. Then the CTS 710 receives the output from the NE and verifies that all three SPEs, including their payload patterns, are intact.

1. Connect the CTS 710 to the NE as shown in Figure 3–1.

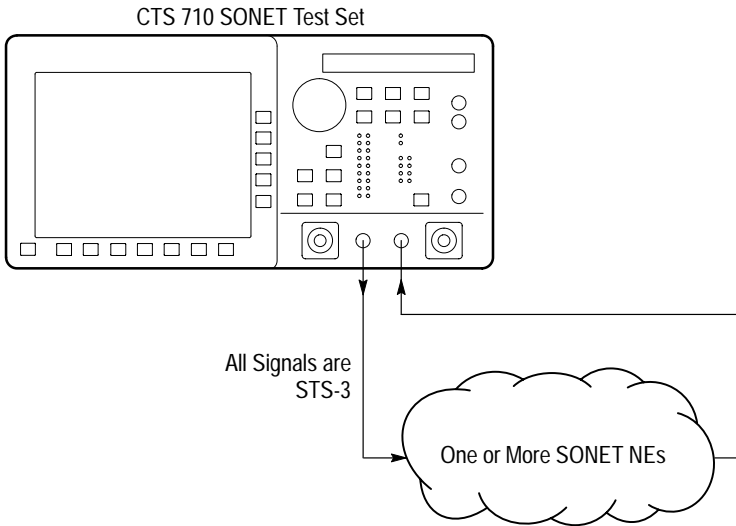

Figure 3–1: Setup to Check Network Continuity

2. Set up the CTS 710 as follows:

Press Menu Button	Select Menu Page	Highlight Parameter	Select Choice
TEST SETUPS	RECALL INSTRUMENT SETUPS	DEFAULT FACTORY SETTINGS	Recall Setup
TRANSMIT	TRANSMIT SETTINGS	Transmit Rate	STS-3

3. Press the **AUTOSCAN** button. The receiver locks onto the output from the NE, displays the signal structure, and shows information about the content of STS #1.
4. To analyze the payload pattern, select **Show Payload**. The CTS 710 detects a PRBS of length $2^{23}-1$.
5. Check the J1 Path Trace for any message.
6. Check the front-panel status lights to verify that there are no errors, alarms, or failures.
7. Select **EXIT** to leave the AUTOSCAN dialog box.
8. To check STS #2, change the CTS 710 setup to:

Press Menu Button	Select Menu Page	Highlight Parameter	Select Choice
TRANSMIT	TRANSMIT SETTINGS	STS Under Test	2

9. Press the **AUTOSCAN** button.
10. Use the knob to select STS #2.
11. Repeat steps 4 through 7 of this procedure to verify the integrity of STS #2.
12. Repeat steps 8 through 11 for the remaining STSs in the SONET signal.

Transmission Signal Quality Testing

Measuring Bit Error Rate

The bit error rate (BER) test is one of the best ways to measure the quality of a SONET transmission link. You can use the CTS 710 to make a BER test on a two-way link that is connected in a loop-back configuration. If this is a test you perform often, save it as a pass/fail test for easy recall.

1. Connect the CTS 710 to a network as shown in Figure 3–2.

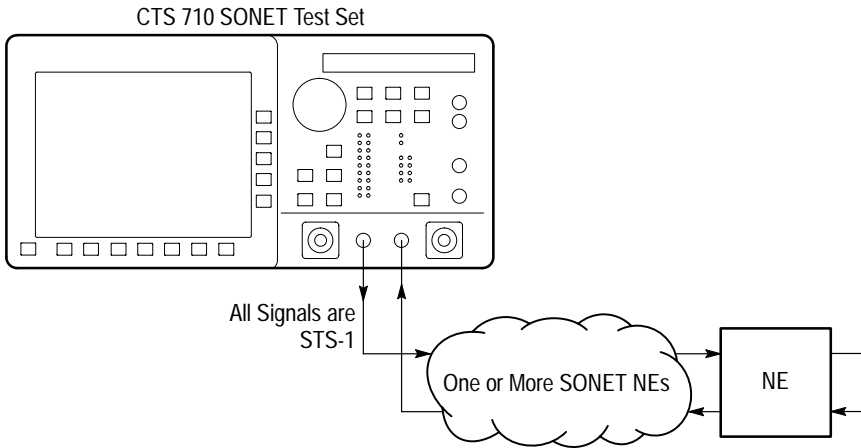

Figure 3–2: Setup to Check a Transmission Link

- Set up the CTS 710 as follows:

Press Menu Button	Select Menu Page	Highlight Parameter	Select Choice
TEST SETUPS	RECALL INSTRUMENT SETUPS	DEFAULT FACTORY SETTINGS	Recall Setup
TRANSMIT	TRANSMIT SETTINGS	Transmit Rate	STS-1
		Mapping	Bulk Fill No Mapping (Equipped)
		Tx/Rx Settings	Coupled
TEST SETUPS	TEST CONTROL	Test Duration	15 Minutes
RESULTS	MAIN RESULTS	<i>none</i>	Errors

- Press the **START/STOP** button.
- While the test is running, the CTS 710 counts errors and errored seconds and then calculates the error ratio for each error type.
- After 15 minutes have elapsed, the test stops automatically and the measured results are held on the MAIN RESULTS page until another test is started.
- When the test is complete, you can store the test results to disk or print out a hardcopy. To save the test results to disk, you must enter a name for the disk file as follows:

Press Menu Button	Select Menu Page	Highlight Parameter	Select Choice
RESULTS	SAVE RESULTS	Name	EDIT NAME

- Enter an eight-character name for the file.

8. If you wish, you can also enter a description of the test results by highlighting **Description** and selecting **EDIT TEXT**.
9. Save the test results to disk as follows:

Press Menu Button	Select Menu Page	Highlight Parameter	Select Choice
		Save to Disk	Save Current

Testing Mapping and Demapping

To test that a DS1 signal is correctly mapped into a SONET signal, you would use a Bit Error Rate test. However, testing mapping/demapping requires a different test setup than that described on page 3-4.

1. Connect the CTS 710 to an Add/Drop Multiplexer (ADM) as shown in Figure 3-3.

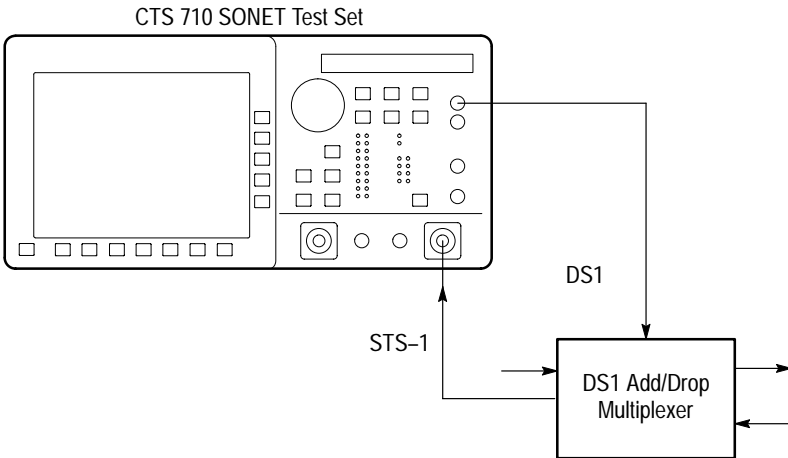

Figure 3-3: Setup to Test Mapping and Demapping

2. Set up the CTS 710 as follows:

Press Menu Button	Select Menu Page	Highlight Parameter	Select Choice
TEST SETUPS	RECALL INSTRUMENT SETUPS	DEFAULT FACTORY SETTINGS	Recall Setup
TRANSMIT	TRANSMIT SETTINGS	Transmit Rate	DS1
RECEIVE	RECEIVE SETTINGS	Receive Rate	STS-1
		Mapping	VT1.5 Async
		VT Under Test	<i>Set to match how the NE is provisioned</i>
		Payload	DS1 Unframed
TEST SETUPS	TEST CONTROL	Test Duration	15 Minutes
RESULTS	MAIN RESULTS	<i>none</i>	Errors

3. Press the **START/STOP** button.

While the test is running, the CTS 710 counts errors and errored seconds and then calculates the error ratio for each error type.

After 15 minutes have elapsed, the test stops automatically and the measured results are held on the MAIN RESULTS page until another test is started.

4. When the test is complete, you can store the test results to disk or print out a hardcopy. To save the test results to disk, you must enter a name for the disk file as follows:

Press Menu Button	Select Menu Page	Highlight Parameter	Select Choice
RESULTS	SAVE RESULTS	Name	EDIT NAME

5. Enter an eight-character name for the file.
6. If you wish, you can also enter a description of the test results by highlighting **Description** and selecting **EDIT TEXT**.
7. Save the test results to disk as follows:

Press Menu Button	Select Menu Page	Highlight Parameter	Select Choice
		Save to Disk	Save Current

Fault Tolerance Checking

Fault tolerance testing (sometimes called stimulus/response testing or stress testing) is used to ensure that a network responds correctly to various fault conditions. Though there are many additional fault conditions you can test with the CTS 710, this section covers three common examples:

- Response to errors and alarms
- Response to pointer movements
- Response to line frequency offset

Response to Errors and Alarms

This example uses two CTS 710s to simultaneously check the upstream and downstream responses to an error or alarm condition. You can use a single CTS 710 to do the same thing by alternately

connecting the upstream and downstream signals to the RECEIVE input.

Table 3–1 shows the responses expected from Line Terminating Equipment (LTE), such as an STS-3/STS-1 multiplexer, when presented with three possible error and alarm conditions.

Table 3–1: LTE Responses to Errors and Alarms

Transmitted Error or Alarm	Expected Upstream Response	Expected Downstream Response
Section B1 Error	Line FEBE	<i>none</i>
LINE AIS	LINE FERF	PATH AIS
PATH FERF	<i>none</i>	PATH FERF

1. Connect two CTS 710s to an LTE as shown in Figure 3–4.

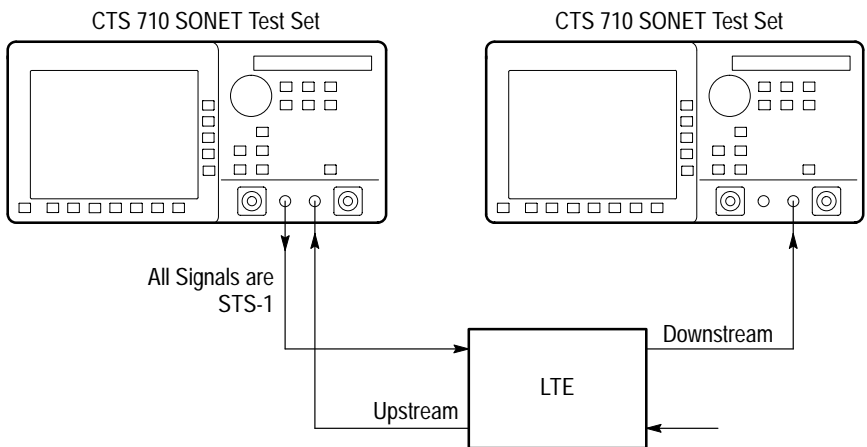

Figure 3–4: Setup to Check Error and Alarm Response

2. To check the LTE response to a Section B1 error, set up the upstream CTS 710 as follows:

Press Menu Button	Select Menu Page	Highlight Parameter	Select Choice
TEST SETUPS	RECALL INSTRUMENT SETUPS	DEFAULT FACTORY SETTINGS	Recall Setup
TRANSMIT	TRANSMIT SETTINGS	Transmit Rate	STS-1
		Tx/Rx Settings	Coupled
TRANSMIT	ERRORS & ALARMS	Error Type	Section B1 BIP
		Error Rate set to	1.0E-5
RESULTS	MAIN RESULTS	<i>none</i>	Errors

3. Set up the downstream CTS 710 as follows:

Press Menu Button	Select Menu Page	Highlight Parameter	Select Choice
TEST SETUPS	RECALL INSTRUMENT SETUPS	DEFAULT FACTORY SETTINGS	Recall Setup
RECEIVE	RECEIVE SETTINGS	Receive Rate	STS-1
RESULTS	MAIN RESULTS	<i>none</i>	Errors

4. Press the **START/STOP** buttons on both the upstream and downstream CTS 710s so that the START/STOP lights are on.
5. Verify that Line FEBE errors are counted in the MAIN RESULTS display of the upstream CTS 710.
6. Verify there are no errors counted in the MAIN RESULTS display of the downstream CTS 710.
7. Press the **START/STOP** buttons on both the upstream and downstream CTS 710s so that the START/STOP lights are off.
8. To check the LTE response to a LINE AIS alarm, change the upstream CTS 710 as follows:

Press Menu Button	Select Menu Page	Highlight Parameter	Select Choice
TRANSMIT	ERRORS & ALARMS	Error Rate set to	None
		Transmit Alarm set to	LINE AIS
RESULTS	MAIN RESULTS	<i>none</i>	Errors

9. Change the downstream CTS 710 as follows:

Press Menu Button	Select Menu Page	Highlight Parameter	Select Choice
RECEIVE	TRANSPORT OVERHEAD	<i>none</i>	<i>none</i>

10. Press the **START/STOP** buttons on both the upstream and downstream CTS 710s so that the START/STOP lights are on.

11. Verify that LINE FERF alarm seconds are counted in the MAIN RESULTS display of the upstream CTS 710.

12. With the downstream CTS 710, verify that the displayed K1 or K2 bytes are not all zeros.

13. Press the **START/STOP** buttons on both the upstream and downstream CTS 710s so that the START/STOP lights are off.

14. To check the LTE response to a PATH FERF alarm, change the upstream CTS 710 as follows:

Press Menu Button	Select Menu Page	Highlight Parameter	Select Choice
TRANSMIT	ERRORS & ALARMS	Error Rate set to	None
		Transmit Alarm set to	PATH FERF
RESULTS	MAIN RESULTS	<i>none</i>	Alarms

15. Change the downstream CTS 710 as follows:

Press Menu Button	Select Menu Page	Highlight Parameter	Select Choice
RESULTS	MAIN RESULTS	<i>none</i>	Alarms

16. Press the **START/STOP** buttons on both the upstream and downstream CTS 710s so that the START/STOP lights are on.

17. Verify that the PATH FERF light is on, on the downstream CTS 710.

Response to Pointer Movements

Pointers allow the SONET network to multiplex signals from independent sources, even if the signal clock rates differ slightly from each other. Within the allowed range, pointer movements should have no adverse affect on the performance of the network.

This example transmits a signal with frequent pointer movements to an NE and checks that the downstream signal is error free.

1. Connect the CTS 710 to an NE as shown in Figure 3–5.

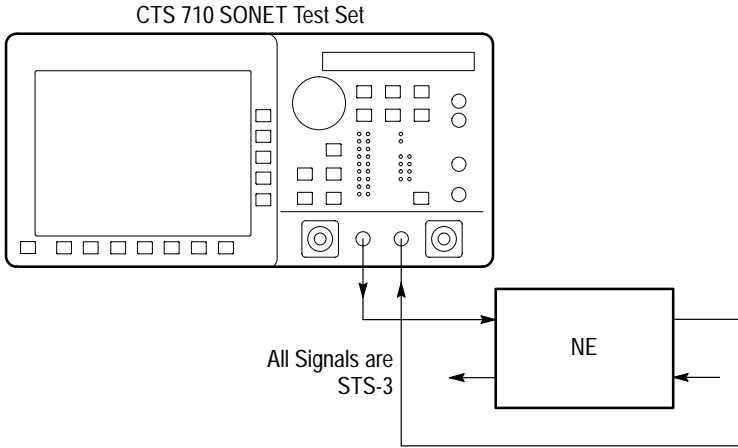

Figure 3-5: Setup to Check Pointer Movements

- Set up the CTS 710 as follows:

Press Menu Button	Select Menu Page	Highlight Parameter	Select Choice
TEST SETUPS	RECALL INSTRUMENT SETUPS	DEFAULT FACTORY SETTINGS	Recall Setup
TRANSMIT	TRANSMIT SETTINGS	Transmit Rate	STS-3
		Tx/Rx Settings	Coupled
TRANSMIT	POINTERS & TIMING	Pointer Control	Continuous
RESULTS	MAIN RESULTS	<i>none</i>	Errors

- Press the **START/STOP** button on the CTS 710 so that the START/STOP light is on.
- Verify that there are no errors in the MAIN RESULTS display. When the front-panel ERROR light is not on, it also indicates there are no errors in the received signal.
- To check for received pointer movements, change the CTS 710 setup as follows:

Press Menu Button	Select Menu Page	Highlight Parameter	Select Choice
RESULTS	MAIN RESULTS	<i>none</i>	Pointers

- Verify that the CTS 710 is counting positive pointer justifications. Depending on the clock rate of the NE, some negative pointer justifications are also possible.

Response to Line Frequency Offset

Pointers also accommodate differences in line frequency from one NE to another. In this example, the CTS 710 transmits a signal at an offset line frequency to an NE and measures the response.

1. Connect the CTS 710 to an NE as shown in Figure 3–6.

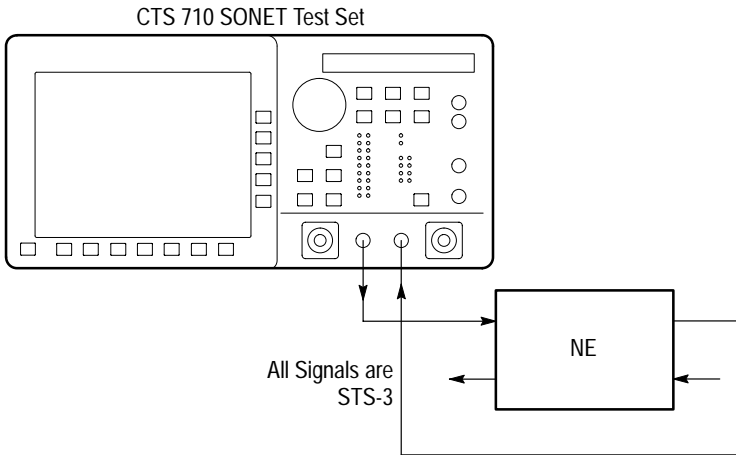

Figure 3–6: Setup to Check Line Frequency Offset Response

2. Set up the CTS 710 as follows:

Press Menu Button	Select Menu Page	Highlight Parameter	Select Choice
TEST SETUPS	RECALL INSTRUMENT SETUPS	DEFAULT FACTORY SETTINGS	Recall Setup
TRANSMIT	TRANSMIT SETTINGS	Transmit Rate	STS-3
		Tx/Rx Settings	Coupled
TRANSMIT	POINTERS & TIMING	Pointer/Timing Mode	Frequency Offset
		Offset Mode	Line
		Frequency Offset	Stress +4.6 ppm
RESULTS	MAIN RESULTS	<i>none</i>	Errors

3. Press the **START/STOP** button on the CTS 710 so that the START/STOP light is on.
4. Verify that there are no errors in the MAIN RESULTS display. When the front-panel ERROR light is not on, it also indicates there are no errors in the received signal.
5. To check that the NE is generating pointer movements, change the CTS 710 setup as follows:

Press Menu Button	Select Menu Page	Highlight Parameter	Select Choice
RESULTS	MAIN RESULTS	<i>none</i>	Pointers

6. Verify that negative pointer justifications are being counted.

Performance Monitoring

When a new line is installed you may want to monitor performance for a day or so to be sure it is operating correctly. Or, if problems are suspected on a line, you may want to run a long test to determine the cause of the problem. In either case, the CTS 710 makes it easy to monitor an electrical or optical line without the need for splitters.

During a test, the CTS 710 simultaneously takes all performance measurements, analyzes the results according to the TIM1.3 standard, and displays the measurements and analysis in your choice of three formats:

- In a brief summary
- In detail by type (error, alarm, failure)
- In detail by layer (section, line, path)

In this example, the CTS 710 is placed directly in line with a live optical signal to monitor performance in an unintrusive mode (Through Mode).

1. Connect the CTS 710 in line with an optical signal as shown in Figure 3–7.

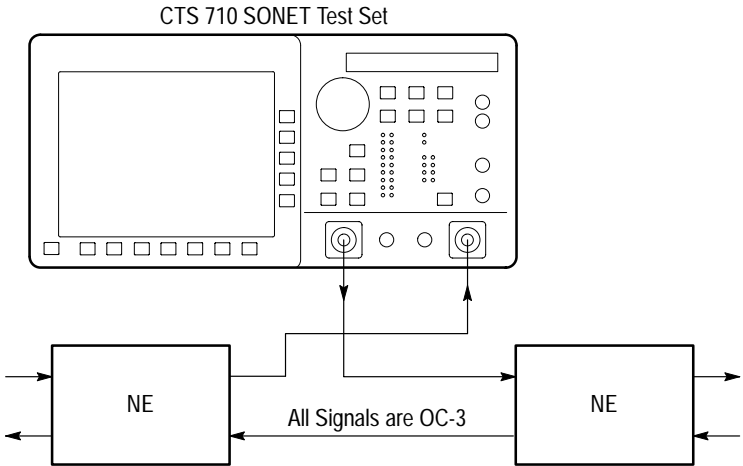

Figure 3-7: Setup to Monitor Performance

2. Set up the CTS 710 as follows:

Press Menu Button	Select Menu Page	Highlight Parameter	Select Choice
TEST SETUPS	RECALL INSTRUMENT SETUPS	DEFAULT FACTORY SETTINGS	Recall Setup
RECEIVE	RECEIVE SETTINGS	Receive Rate	OC-3
TRANSMIT	TRANSMIT SETTINGS	Tx/Rx Settings	Through Mode
RESULTS	ERROR ANALYSIS	<i>none</i>	Section Analysis

3. Press the **START/STOP** button on the CTS 710 so that the START/STOP light is on.
4. As the test is running, the analysis of Section errors continually updates. You can also look at the analysis of Line, Path, or

Payload errors by pressing the buttons corresponding to those choices.

5. To see network performance data since the start of the test presented in graphical form, change the CTS 710 setup as follows:

Press Menu Button	Select Menu Page	Highlight Parameter	Select Choice
RESULTS	HISTORY GRAPHS	<i>none</i>	<i>none</i>

6. The CTS 710 history graphs can cover a time span up to 72 hours. You can choose history graphs of the measured performance indicators in the following categories:
 - Error count (any error you choose)
 - Errored seconds (any error you choose)
 - Pointer justifications
 - Pointer value
 - All failures
 - All alarms

7. For example, to change the bottom graph to display the history of Path B3 Errored Seconds, change the CTS 710 setup as follows:

Press Menu Button	Select Menu Page	Highlight Parameter	Select Choice
RESULTS	HISTORY GRAPHS	<i>none</i>	Change Bottom
		<i>turn the knob to select the desired graph</i>	Path B3 Errored Secs
			Select Graph

8. Turning the knob moves the cursor from one bar to the next. The specific measurement values at the cursor location are shown in the display.
9. Once the graph fills the width of the display, you can pan through the entire test using the knob.
10. You can compress or expand the time scale with the Zoom Out or Zoom In action buttons. Press the button next to Zoom Out to change the time scale to 5 minutes per bar.

Setting Test Control Parameters

This section describes how to set the duration for a test, the resolution of the test history, and how to start and stop a test. It also lists parameters that cannot be adjusted during a test and other actions that cannot be performed while a test is running.

Setting the Test Time Duration

Before running a test, you must specify how long the test will run. The default test duration is continuous, which means a test runs until you stop it with the START/STOP button.

To set the duration of a test:

Press Menu Button	Select Menu Page	Highlight Parameter	Select Choice
TEST SETUPS	TEST CONTROL (see Figure 3-8)	Test Duration	5 min
			15 min
			1 hour
			Continuous
			USER DEFINED

- Select **Continuous** to set the test to run until the START/STOP button is pressed. If you select Continuous, the CTS 710 accumulates measurements from the time you start the test until the time you stop the test.

Once the test duration is set, any time a test is started it will run for the time specified on the Test Duration line.

NOTE. *If an instrument setup or pass/fail test is recalled from memory or disk, it overwrites the test duration specified on the TEST TIME page.*

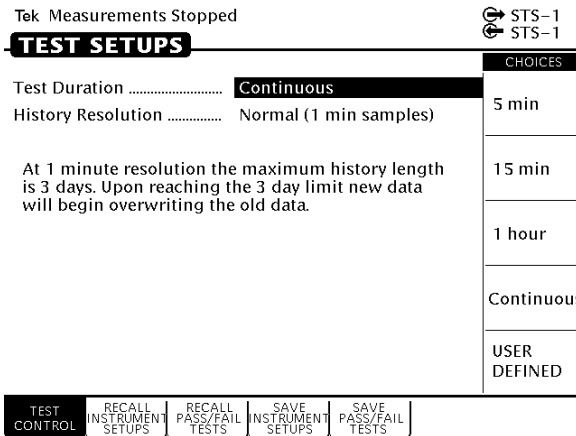

Figure 3-8: The Test Control Page

Setting a Unique Test Time Duration

To set a test duration time other than the three choices presented, use the USER DEFINED choice.

To set a unique test duration:

Press Menu Button	Select Menu Page	Highlight Parameter	Select Choice
TEST SETUPS	TEST CONTROL	<i>none</i>	USER DEFINED (see Figure 3-9)
			Day
			Hour
			Minute
			Second

- Select **Day**, **Hour**, **Minute**, or **Second** as appropriate, then use the knob to set the duration of the selected period. Set each choice as necessary.
- Select **DONE** when finished setting the duration to enter the specified test duration.

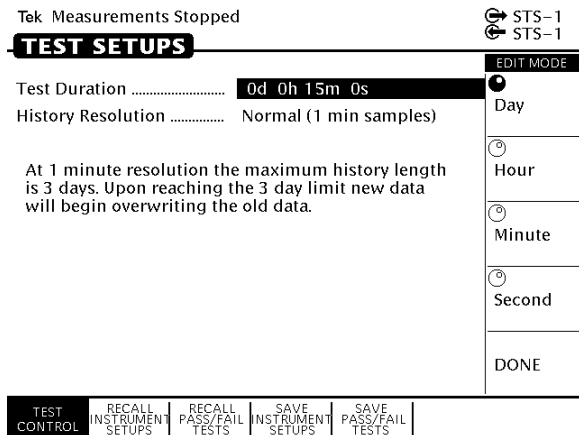

Figure 3-9: Setting a USER DEFINED Test Duration

Table 3–2 lists the range limits for the test duration.

Table 3–2: Test Duration Limits

Choice	Range	Increment
Day	0 to 99	1
Hour	0 to 23	1
Minute	0 to 59	1
Second	0 to 59	1

NOTE. *Although a test can be set to run up to 99 days, 23 hours, 59 minutes, and 59 seconds, only results from a limited period are saved in memory. The period of test results saved is determined by the History Resolution setting.*

Setting the History Resolution

The history of test results can be recorded at two resolutions, either 1 minute or 15 minutes. At 1-minute resolution, 3 days worth of test results can be recorded. At 15-minutes resolution, 45 days worth of test results can be recorded.

To set the history resolution of a test:

Press Menu Button	Select Menu Page	Highlight Parameter	Select Choice
TEST SETUP	TEST CONTROL (see Figure 3-8 on page 3-24)	History Resolution	Normal (1 min)
			Low (15 min)

Starting and Stopping a Test

To start or stop a test:

- Press **START/STOP**.

When a test starts, the light next to the START/STOP button turns on and the status line displays the message, Running.

NOTE. Pressing **START/STOP** while a test is running stops the test immediately, even if the test time has not expired.

While a test is running, the status line shows the elapsed time since the test began. If a limited test duration has been set (any setting other than Continuous), a bar graph indicates the current percentage of test completion. Figure 3-10 shows the locations of the elapsed time indicator and bar graph.

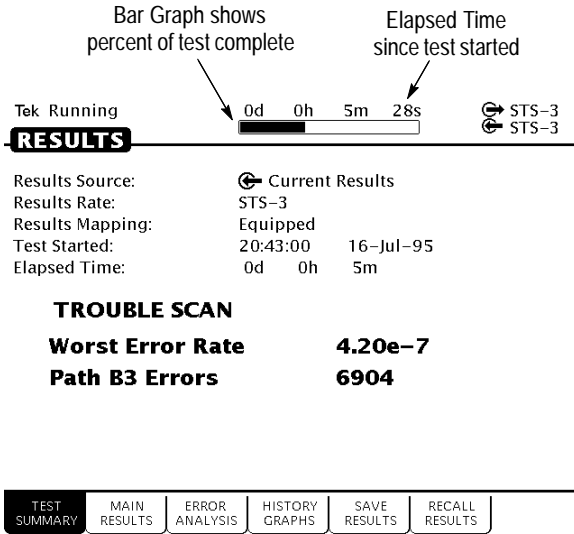

Figure 3-10: Elapsed Time and Bar Graph Indicators

Making Changes While Running a Test

If you change instrument receive settings while a test is running, the test is restarted. Error counts are cleared and the test begins again using the new settings. You can change transmitter settings while a test is running without restarting the test.

Actions You Cannot Perform While Running a Test

There are actions you cannot perform while a test is running (see Table 3-3). You cannot recall instrument settings, pass/fail tests, or results and you cannot save results while a test is running. If you try to perform a recall while a test is running, you are warned that a recall is not allowed while a test is running.

Table 3-3: Actions You Cannot Perform While a Test is Running

Menu	Page	Action
TEST SETUPS	RECALL INSTRUMENT SETUPS	Recall an instrument setup
	RECALL PASS/FAIL TESTS	Recall a pass/fail test
RESULTS	RECALL RESULTS	Recall previous results
	SAVE RESULTS	Save current results to disk
UTILITY	SELF TEST	Execute self test or diagnostics
AUTOSCAN		Autoscan the received signal

Working with Test Setups

This section describes how to save instrument setups to disk, recall instrument setups, create pass/fail tests, and run a pass/fail test.

Instrument setups are files, stored in memory or on disk, that completely describe how the CTS 710 is set up. You can use this feature to ensure that every time a test is run, using an instrument setup, that the CTS 710 is configured the same way, thus ensuring consistent results. The disk file is an ASCII format file that consists of SCPI commands. The disk file can be edited with any ASCII file editor.

Pass/fail tests are tests that display a message indicating whether the completed test encountered any of the specified failure conditions. Up to four failure conditions can be specified in a pass/fail test. Pass/fail tests can be configured to save test results to disk or to print out the test results when the test completes.

Saving and Recalling Instrument Setups

Instrument setups are files stored in memory or on disk that define how the CTS 710 is configured. If you regularly set up the CTS 710 in the same way, you can save the instrument settings in an instrument setup. Then you can recall the instrument setup whenever you want the CTS 710 configured a certain way. This capability saves you time and minimizes the chances of error when setting up the CTS 710 for standard tasks.

NOTE. *Instrument setups saved to memory are retained when the instrument is turned off. Instrument setups are retained in memory even if power is removed from the CTS 710.*

Saving Instrument Setups

To save an instrument setup:

1. Set up the CTS 710 as desired. Set all instrument parameters as required.
2. To save an instrument setup to disk, it must have a name. Enter a file name as follows:

Press Menu Button	Select Menu Page	Highlight Parameter	Select Choice
TEST SETUPS	SAVE INSTRUMENT SETUPS (see Figure 3-11)	Name	SETUP_XX
			EDIT NAME

- If you wish to label the setup file as SETUP<Number>, you can save time by selecting **SETUP_XX**. Once you select **SETUP_XX**, select **EDIT NAME** and edit **XX** to the desired number (or letter). Select **DONE** when you are finished editing the setup name. The instrument setup name can be up to eight characters long.
- Select **EDIT NAME** to enter a name other than **SETUP_XX**. Select **DONE** when you are finished editing the setup name. The instrument setup name can be up to eight characters long.

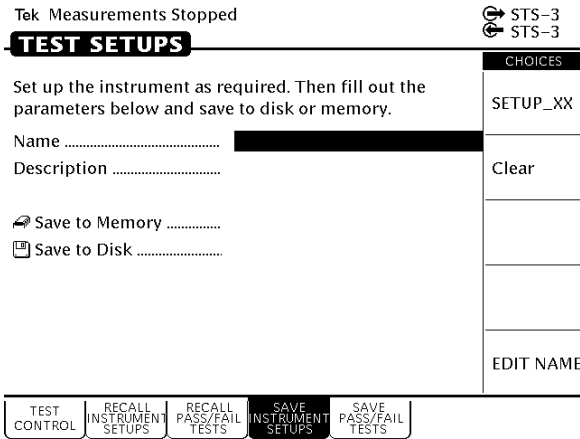

Figure 3–11: The SAVE INSTRUMENT SETUPS Page

3. Enter a description of the instrument setup as follows:

Press Menu Button	Select Menu Page	Highlight Parameter	Select Choice
		Description	EDIT TEXT

- Select **EDIT TEXT** to edit the description of the instrument setup. The description can be up to 24 characters long. To remove an existing description, select **Clear** or **None**.

4. Save the instrument setup to memory as follows:

Press Menu Button	Select Menu Page	Highlight Parameter	Select Choice
		Save to Memory	Memory n

5. Save the instrument setup to disk as follows:

- Insert a disk to store the file on, if one has not already been inserted.

Press Menu Button	Select Menu Page	Highlight Parameter	Select Choice
		Save to Disk	Save File

The instrument setup is saved to disk with the name specified on the Name line. Status messages indicate the progress of the file save. Once the file is written to disk, the CTS 710 reads the disk directory and updates the file listing shown on the RECALL INSTRUMENT SETUPS page.

Recalling Instrument Setups

To recall an instrument setup from memory:

Press Menu Button	Select Menu Page	Highlight Parameter	Select Choice
TEST SETUPS	RECALL INSTRUMENT SETUPS (see Figure 3-12)	<i>none</i>	Memory
		<i>none</i>	Disk
		<i>select setup</i>	Recall Setup

- Use the knob to select the desired instrument setup.
- To recall setups from memory rather than disk, select **Memory** to highlight the Memory listing (see Figure 3-12).
- To recall setups from disk rather than memory, select **Disk** to highlight the Disk listing.

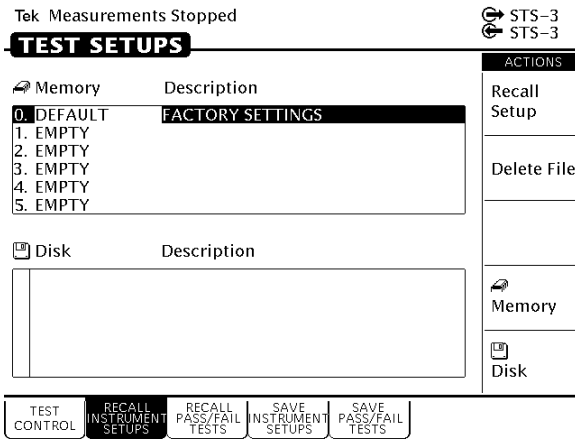

Figure 3–12: The RECALL INSTRUMENT SETUPS Page

The disk file listing displays up to six file names at a time. If more than six files are on disk, the file listing automatically scrolls when you turn the knob.

Recalling the Default Factory Setup

To recall the default factory setup (initialize the CTS 710):

Press Menu Button	Select Menu Page	Highlight Parameter	Select Choice
TEST SETUPS	RECALL INSTRUMENT SETUPS (see Figure 3–12)	<i>none</i>	Memory
		0. Default	Recall Setup

Recall the default settings whenever you want to restore the CTS 710 to a known state. For a listing of the factory default settings, see page C–1.

Deleting Instrument Setups from Disk

You can delete instrument setups from disk using the Delete File action.

To delete an instrument setup from disk:

Press Menu Button	Select Menu Page	Highlight Parameter	Select Choice
TEST SETUPS	RECALL INSTRUMENT SETUPS (see Figure 3–12)	<i>none</i>	Disk
		<i>select setup</i>	Delete File

- Use the knob to select the file to delete (see Figure 3–13).

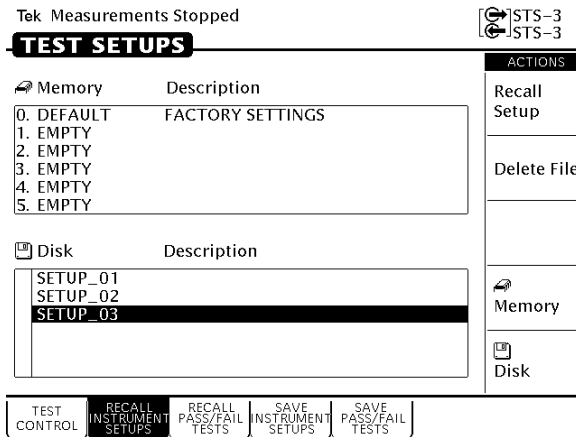

Figure 3–13: Selecting a Disk File for Deleting

After you select Delete File, status messages appear indicating the progress of the file deletion. When the file has been deleted, the file listing updates.

Pass/Fail Tests

A pass/fail test is an easy way to run a test and get a simple response stating whether or not the CTS 710 encountered the specified errors during the test. When a pass/fail test completes, the CTS 710 displays a message stating that either the test passed or failed. Pass/fail tests are set up in the TEST SETUPS menu on the SAVE PASS/FAIL TESTS page (see Figure 3–14). A pass/fail test consists of instrument setup information and the parameters described in *Parameters of a Pass/Fail Test*.

Tek Measurements Stopped ↻ STS-1
↻ STS-1

TEST SETUPS

CHOICES

Set up the instrument as required. Then fill out the parameters below and save your test to disk.

Name XXXXXXXXXX

Description

Operator Start Prompt

Test Duration 0d 0h 15m 0s

Fail If	None	None	None
	None	None	None
	None	None	None
	None	None	None

Operator End Prompt

On Test Completion Do Nothing

Save to Disk

EDIT NAME

TEST TIME

RECALL INSTRUMENT SETUPS

RECALL PASS/FAIL TESTS

SAVE INSTRUMENT SETUPS

SAVE PASS/FAIL TESTS

Figure 3–14: The SAVE PASS/FAIL TESTS Page

Parameters of a Pass/Fail Test

A pass/fail test has the following parameters (some parameters are optional):

- **Name.** The name of the test, a mandatory parameter. It can be up to eight-characters long. The name of the test also serves as the file name for the test when you save it to disk.

NOTE. *A pass/fail test can only be saved on disk. It cannot be saved in memory.*

- **Description.** An optional, 24-character field that describes the test.
- **Operator Start Prompt.** An optional, 72-character field that is displayed at the beginning of the test. You can use the operator start prompt to provide instruction to the operator prior to the beginning of the test.
- **Test Duration.** A required parameter that sets the length of the test.
- **Fail If conditions.** The specific conditions that define whether a test has failed.
- **Operator End Prompt.** An optional, 72-character field that is displayed at the end of the test. You can use the operator end prompt to provide instruction to the operator after the test is completed.
- **On Test Completion.** A required parameter that defines the action to be taken when a test completes.

Fail If Conditions

A Fail If condition is what determines if a test passes or fails. There are three elements to a Fail If condition: condition type, specific condition, and threshold (see Table 3–4).

The condition type describes the general condition that indicates a test has failed. For each condition type (except None), there is list of specific conditions and thresholds used to determine when a test fails. None indicates that no condition type has been assigned.

The specific condition describes the type of failure used to determine when a test fails. The specific conditions that define a failure depend on the condition type (see Table 3–4).

The threshold is the level at which a test fails (see Table 3–4). For example, for the condition types Alarm and Failure, the threshold for any specific condition is Detected or Not Detected.

- Detected. If the specified condition is detected, the test fails.
- Not Detected. If the specified condition is not detected, the test fails.

Table 3–4: Fail If Conditions of a Pass/Fail Test

Condition Type	Specific Condition	Threshold
Alarm	Any	Detected/Not Detected
	Line AIS	Detected/Not Detected
	Line FERF	Detected/Not Detected
	Path AIS	Detected/Not Detected
	PATH FERF	Detected/Not Detected
	VT AIS	Detected/Not Detected
	VT FERF	Detected/Not Detected
	DSn AIS	Detected/Not Detected
	Yellow	Detected/Not Detected
Failure	Any	Detected/Not Detected
	LOS	Detected/Not Detected
	LOF	Detected/Not Detected
	STS LOP	Detected/Not Detected
	VT LOP	Detected/Not Detected
	VT LOM	Detected/Not Detected
	Pattern Sync	Detected/Not Detected
Error Ratio	Any	>1.0e-9 >1.0e-8 >1.0e-7 >1.0e-6 USER

Table 3-4: Fail If Conditions of a Pass/Fail Test (Cont.)

Condition Type	Specific Condition	Threshold
	Section B1	>1.0e-9 >1.0e-8 >1.0e-7 >1.0e-6 USER
	Line B2	>1.0e-9 >1.0e-8 >1.0e-7 >1.0e-6 USER
	Path B3	>1.0e-9 >1.0e-8 >1.0e-7 >1.0e-6 USER
	VT BIP	>1.0e-9 >1.0e-8 >1.0e-7 >1.0e-6 USER
	VT FEBE	>1.0e-9 >1.0e-8 >1.0e-7 >1.0e-6 USER
	Payload BIT	>1.0e-9 >1.0e-8 >1.0e-7 >1.0e-6 USER
	DS3 Parity	>1.0e-9 >1.0e-8 >1.0e-7 >1.0e-6 USER

Table 3-4: Fail If Conditions of a Pass/Fail Test (Cont.)

Condition Type	Specific Condition	Threshold
	DS1 CRC	>1.0e-9 >1.0e-8 >1.0e-7 >1.0e-6 USER
Error Count	Any	>0 >10 >100 >1000 USER (0 - 10000)
	Section B1	>0 >10 >100 >1000 USER (0 - 10000)
	Line B2	>0 >10 >100 >1000 USER (0 - 10000)
	Path B3	>0 >10 >100 >1000 USER (0 - 10000)
	VT BIP	>0 >10 >100 >1000 USER (0 - 10000)
	VT FEBE	>0 >10 >100 >1000 USER (0 - 10000)

Table 3-4: Fail If Conditions of a Pass/Fail Test (Cont.)

Condition Type	Specific Condition	Threshold
	Payload BIT	>0 >10 >100 >1000 USER (0 – 10000)
	DS3 Parity	>0 >10 >100 >1000 USER (0 – 10000)
	DS1 CRC	>0 >10 >100 >1000 USER (0 – 10000)
Errored Seconds	Any	>0 >1 >10 >60 USER (0-10000)
	Section B1	>0 >1 >10 >60 USER (0-10000)
	Line B2	>0 >1 >10 >60 USER (0-10000)
	Path B3	>0 >1 >10 >60 USER (0-10000)

Table 3-4: Fail If Conditions of a Pass/Fail Test (Cont.)

Condition Type	Specific Condition	Threshold
	VT BIP	>0 >1 >10 >60 USER (0-10000)
	VT FEBE	>0 >1 >10 >60 USER (0-10000)
	Payload BIT	>0 >1 >10 >60 USER (0-10000)
	DS3 Parity	>0 >1 >10 >60 USER (0-10000)
	DS1 CRC	>0 >1 >10 >60 USER (0-10000)
Pointer	STS NDFs	>0 >1 >10 >60 USER (0-10000)
	STS Ptr. Justifys	>0 >1 >10 >60 USER (0-10000)

Table 3-4: Fail If Conditions of a Pass/Fail Test (Cont.)

Condition Type	Specific Condition	Threshold
	VT NDF's	>0 >1 >10 >60 USER (0-10000)
	VT Ptr. Justifys	>0 >1 >10 >60 USER (0-10000)

Creating a Pass/Fail Test

To create a pass/fail test:

1. Set up the CTS 710 as required to perform the desired test.
Set all transmit and receive parameters as necessary. When the pass/fail test is recalled, the CTS 710 is set up exactly as it was when the pass/fail test was saved.
2. Set the name of the pass/fail test as follows:

Press Menu Button	Select Menu Page	Highlight Parameter	Select Choice
TEST SETUPS	SAVE PASS/FAIL TESTS (see Figure 3-14)	Name	TEST_XX
			EDIT NAME
			Clear

- If you wish to name the test file as TEST<Number>, you can save time by selecting **TEST_XX**. Once you select TEST_XX, select **EDIT NAME** and edit XX to the desired

number (or letter). Select **DONE** when you are finished editing the setup name.

- Select **EDIT NAME** to enter a name other than TEST_XX for the pass/fail test. Select **DONE** when you are finished editing the test name.
- Select **Clear** to remove an existing name.

3. Enter a description of the pass/fail test as follows:

Press Menu Button	Select Menu Page	Highlight Parameter	Select Choice
TEST SETUPS	SAVE PASS/FAIL TESTS	Description	EDIT TEXT
			None
			Clear

- Select **EDIT TEXT** to enter a description of the test, up to 24 characters long. Select **DONE** when you are finished editing the description.
- Select **None** if you do not want to use a description.
- Select **Clear** to remove an existing description.

4. Enter an operator start prompt as follows:

Press Menu Button	Select Menu Page	Highlight Parameter	Select Choice
TEST SETUPS	SAVE PASS/FAIL TESTS	Operator Start Prompt	Default
			Clear
			Preview
			EDIT TEXT

- Select **Default** to enter the default prompt TEST IS ABOUT TO START!.
- Select **Clear** to remove any previously entered prompt text.
- Select **Preview** to see how the prompt text you have entered appears in the pass/fail test dialog box. Select **EXIT** to remove the preview.
- Select **EDIT TEXT** to enter an operator start prompt, up to 72 characters long. The prompt appears on the display as three lines of 24 characters. Select **DONE** when you are finished editing the prompt.

5. Set the test duration as follows:

Press Menu Button	Select Menu Page	Highlight Parameter	Select Choice
TEST SETUPS	SAVE PASS/FAIL TESTS	Test Duration	5 min
			15 min
			1 hour
			Continuous
			USER DEFINED

- Select **USER DEFINED** to enter a time other than one of the preset choices. The maximum duration is 99 days, 23 hours, 59 minutes, 59 seconds.
6. Highlight the first entry in the first column of the Fail If table (see Figure 3–15). Select one of the preset choices to specify a condition type.

Tek Measurements Stopped
↔ STS-1
↺ STS-1

TEST SETUPS

CHOICES

Set up the instrument as required. Then fill out the parameters below and save your test to disk.

Name TEST_1A

Description

Operator Start Prompt TEST IS ABOUT TO START!

Test Duration 0d 0h 15m 0s

	None	None	None
Fail If	None	None	None
	None	None	None
	None	None	None

Operator End Prompt

On Test Completion Do Nothing

Save to Disk Select Action

TEST TIME
RECALL INSTRUMENT SETUPS
RECALL PASS/FAIL TESTS
SAVE INSTRUMENT SETUPS
SAVE PASS/FAIL TESTS

Alarm

 Failure

 Error Ratio

 Error Count

 -more-
 1 of 2

Figure 3–15: Entering Fail If Conditions

7. Highlight the first entry in the second column (see Figure 3–15). If you wish to specify a specific condition, select one of the preset choices.
8. Highlight the first entry in the third column (see Figure 3–15). Select one of the preset choices to set the threshold. Select **USER** to specify a threshold other than one of the preset choices. (USER is not available for Alarm or Failure condition types.)
9. Repeat steps 6 through 8 as necessary to specify additional Fail If conditions. A maximum of four Fail If conditions can be specified.
10. Enter an operator end prompt as follows:

Press Menu Button	Select Menu Page	Highlight Parameter	Select Choice
TEST SETUPS	SAVE PASS/FAIL TESTS	Operator End Prompt	Default
			Clear
			Preview
			EDIT TEXT

- Select **Default** to enter the default prompt TEST HAS ENDED!.
- Select **Clear** to remove any previously entered prompt text.
- Select **Preview** to see how the prompt text you have entered appears in the pass/fail test dialog box. Select **Exit** to remove the preview.
- Select **EDIT TEXT** to enter an operator end prompt, up to 72 characters long. The prompt appears on the display as three lines of 24 characters. Select **DONE** when you are finished editing the prompt.

11. Specify the action to be taken when the test completes as follows:

Press Menu Button	Select Menu Page	Highlight Parameter	Select Choice
TEST SETUPS	SAVE PASS/FAIL TESTS	On Test Completion	Do Nothing
			Print Summary
			Save to Disk

- Select **Do Nothing** if you do not want any action taken at test completion.
- Select **Print Summary** to print the test results when the test completes.
- Select **Save to Disk** to create a disk file of the test results when the test completes.

12. Save the pass/fail test to disk as follows:

Press Menu Button	Select Menu Page	Highlight Parameter	Select Choice
TEST SETUPS	SAVE PASS/FAIL TESTS	Save to Disk	Save File

Running a Pass/Fail Test

To run a pass/fail test:

1. Insert the disk containing the pass/fail test into the disk drive.

2. Select the pass/fail test to run as follows:

Press Menu Button	Select Menu Page	Highlight Parameter	Select Choice
TEST SETUPS	RECALL PASS/FAIL TESTS	<i>none</i>	Disk
		<i>select disk file name</i>	Recall

NOTE. *The Disk action displays only files with the extension .TST.*

Selecting Recall begins the recall of the pass/fail test.

As the file recall begins, the TEST BEGIN dialog box appears (see Figure 3–16). The first line of text in the dialog box is the file name. The second line of text is the test description. The third line informs the user that the file was recalled successfully. The fourth line states how to begin the test. The fifth line is the operator start prompt.

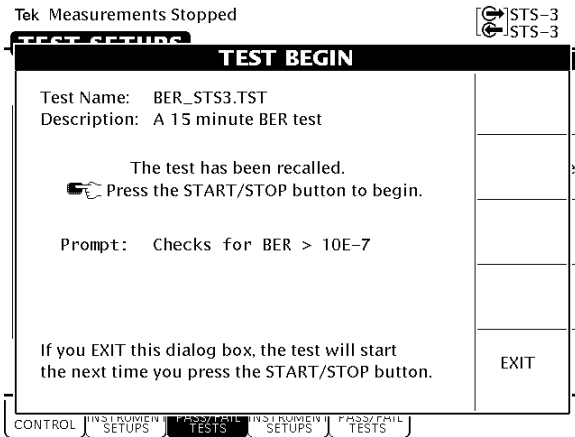

Figure 3–16: The TEST BEGIN Dialog Box

3. To run the pass/fail test immediately, press **START/STOP**.

The pass/fail test will begin. When the test is completed, the CTS 710 displays either **TEST PASSED!** or **TEST FAILED!**.

If you decide not to run the test, select **EXIT** from the dialog box.

4. Select **EXIT** to remove the dialog box after the test completes.
5. Press **RESULTS** to see the detailed results of the test.

A test does not have to be run when it is recalled from disk. After the TEST BEGIN dialog box appears, you can exit the dialog box by selecting **EXIT**. You can then select the **SAVE PASS/FAIL TESTS** page and edit the parameters of the pass/fail test.

Changing an Existing Pass/Fail Test

You do not have to create a pass/fail test from the beginning every time. You can recall an existing test, edit the parameters of the test, and then save it under a new name.

To change an existing pass/fail test:

1. Insert the disk containing the pass/fail test into the disk drive.
2. Select the pass/fail test to edit as follows:

Press Menu Button	Select Menu Page	Highlight Parameter	Select Choice
TEST SETUPS	RECALL PASS/FAIL TESTS	<i>none</i>	Disk
		<i>select disk file name</i>	Recall

NOTE. *The Disk action displays only files with the extension .TST.*

As the file recall begins, the TEST BEGIN dialog box appears (see Figure 3–16).

3. Select **EXIT** to remove the dialog box.
4. Select **SAVE PASS/FAIL TESTS**.
5. Edit the parameters of the pass/fail test as necessary.
6. If you want to save the edited pass/fail test under a different name, change the Name of the test. You do not have to change the name of the test file to save it to disk.
7. Save the pass/fail test to disk as follows:

Press Menu Button	Select Menu Page	Highlight Parameter	Select Choice
TEST SETUPS	SAVE PASS/FAIL TESTS	Save to Disk	Save File

- If you select Save File without changing the name of the file, a Disk dialog box appears asking if you want to overwrite the

existing file. To overwrite the file, select **Overwrite**. If you do not want to overwrite the file, select **Cancel**.

Deleting a Pass/Fail Test from Disk

Delete a pass/fail test from disk as follows:

Press Menu Button	Select Menu Page	Highlight Parameter	Select Choice
TEST SETUPS	RECALL PASS/FAIL TESTS	<i>select file name</i>	Delete File

- If necessary, select **Disk** from the list of actions to display the names of the files on disk (see Figure 3–17).

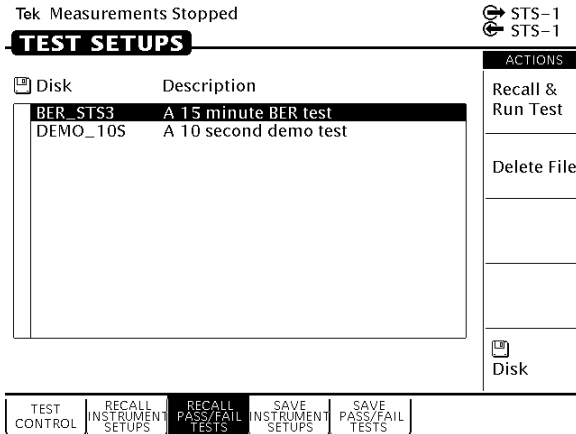

Figure 3–17: Selecting a Pass/Fail Test for Deleting

After you select Delete, status messages appear indicating the progress of the file deletion. The file list updates after the file is deleted.

Checking Signal Status

This section describes how to use the CTS 710 to check signal status. The CTS 710 continuously monitors the input signal for alarms, errors, and failures and provides indicators for the current signal status as well as indicating the history of the signal status.

Viewing Signal Structure

The quickest way to view the structure of a signal is to use AUTOSCAN. AUTOSCAN analyzes the input signal and once a signal is found, the CTS 710 synchronizes with the signal and displays the structure of the signal.

To view signal structure using AUTOSCAN:

1. Connect a signal to the receiver input.
2. If a test is running, stop the test by pressing **START/STOP**.
3. Press the **AUTOSCAN** front-panel button.

While AUTOSCAN is running, several messages appear in the display. While the CTS 710 searches for a signal it displays the message: Please wait, autosetting to received signal. The CTS 710 scans all line rates and all receiver input connectors until it finds a framed signal. When the CTS 710 finds a framed signal, the instrument displays the message: Autosetting to received signal. If a signal is not found, a message to that effect is displayed.

When the AUTOSCAN finishes, the CTS 710 displays the signal structure in graphical form (see Figure 3–18). Use the knob to scroll through the different active channels.

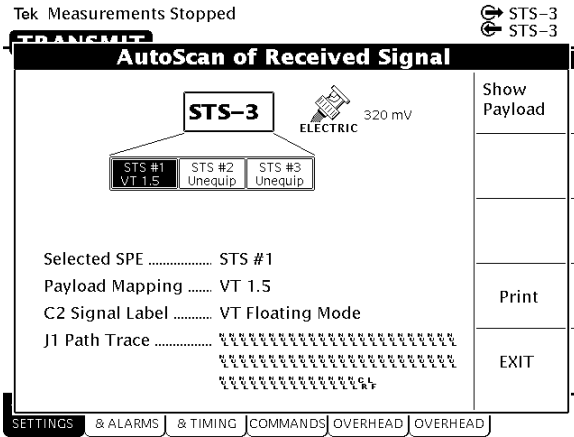

Figure 3-18: The AUTOSCAN Dialog Box Showing Signal Structure

Viewing the Payload (Add/Drop/Test Option Only)

If the received signal uses tributary mapping, then Autoscan can display the different tributaries within the STS.

To display the tributary payload, highlight an STS where VT 1.5 is shown as the mapping and select the **Show Payload** choice (see Figure 3-19).

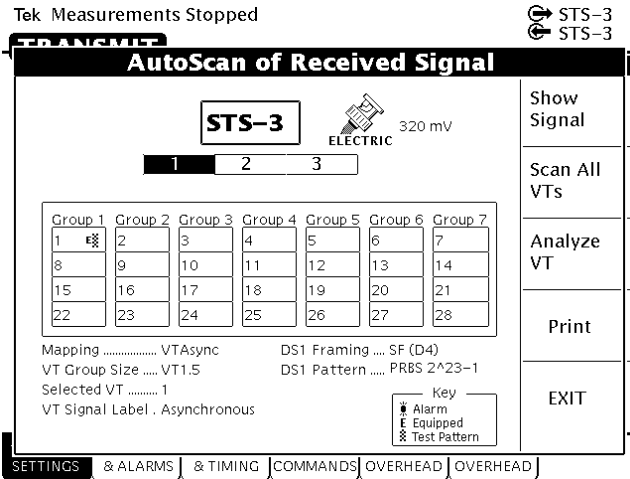

Figure 3-19: Viewing Tributary Signal Structure

Determining the Payload Pattern and Framing (Add/Drop/Test Option Only)

To search for a pattern in the data of the received signal or determine the framing, select **Analyze VT**. After you select Analyze VT, the CTS 710 scans the selected VT in the received signal to see if there is a pattern within the data and if the signal is framed. If a pattern is found, it is displayed below the payload map on the Pattern line (for example, PRBS 2²³-1). If the CTS 710 is unable to find a pattern within the signal, it displays Unknown on the Pattern line. The CTS 710 will display Unframed or Framed on the Framing line.

To scan every VT in the received signal, select **Scan All VTs**. As the CTS 710 scans the signal, it will indicate for each VT whether it has detected an alarm, whether the VT is equipped, and whether a test pattern was found in the VT. The key which describes each of the indicators is located in the lower, right corner of the AutoScan dialog box (see Figures 3-19 and 3-20).

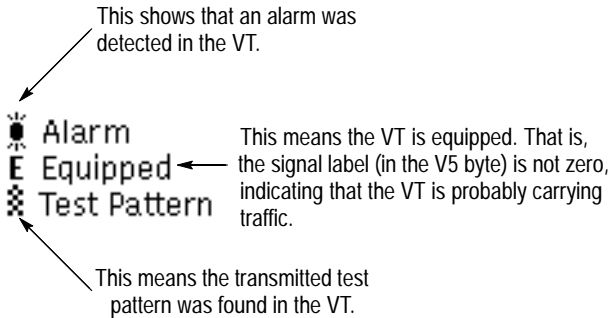

Figure 3–20: The Meaning of the Icons in the Autoscan Dialog Box

You exit the AUTOSCAN dialog box by selecting **EXIT**. When you exit the AUTOSCAN dialog box, the receiver settings are set to match the active channel most recently selected.

Printing the AutoScan Dialog Box

You can print the AutoScan dialog box by selecting **Print**. This prints the displayed dialog box using the settings on the **PRINTER SETUP** page of the **UTILITY** menu. The printout takes about two minutes.

Viewing the Signal State

Three colors are used to indicate signal state: green, red, and yellow (see Figure 3–21).

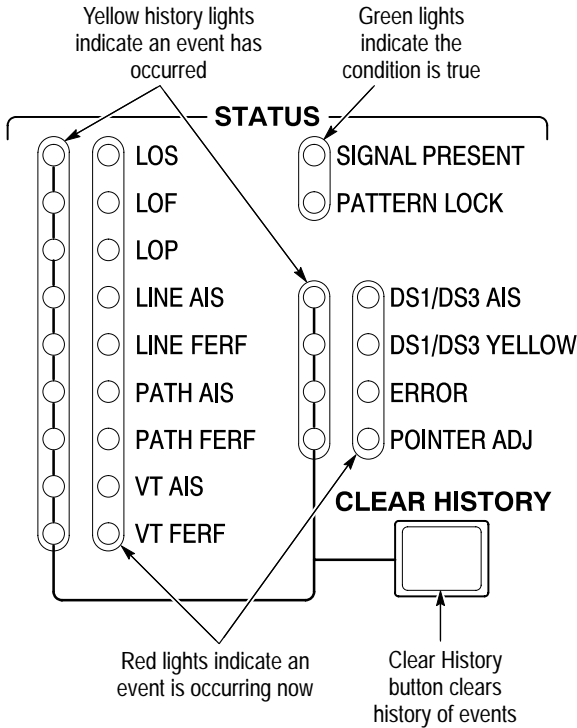

Figure 3-21: Front-Panel Status Lights (with Add/Drop/Test Option Installed)

- Green lights indicate the condition is true. See Table 3-5.

Table 3-5: Green Status Lights

Label on Light	Meaning if Light is On
SIGNAL PRESENT	A signal at the line rate specified by the Receive Rate parameter is present.
PATTERN LOCK	Lock to a PRBS or fixed pattern has been achieved.

- Red lights indicate the associated condition is valid. For example, if the red light next to LOS is on, no signal is being received. See Table 3–6.
- A yellow light is associated with each red light. The yellow lights are turned on when an error, alarm, or failure condition first occurs and then stay on to indicate the history even if the condition goes away (see Table 3–6). Press the **CLEAR HISTORY** button to clear the status history.

Table 3–6: Red and Yellow Status Lights

Label on Light	Meaning if Light is On
LOS	Loss of received signal.
LOF	Loss of frame of received signal.
LOP	Loss of STS or VT pointer for selected channel in received signal.
LINE AIS	A line alarm indication signal is being received.
LINE FERF	A line far end receive failure code is being received.
PATH AIS	A path alarm indication signal is being received.
PATH FERF	A path far end receive failure signal is being received.
VT AIS	A tributary alarm indication signal is being received. (Add/Drop/Test Option Only)
VT FERF	A tributary far end receive failure is being received. (Add/Drop/Test Option Only)
DS1/DS3 AIS	A tributary alarm indication signal is being received. (Add/Drop/Test Option Only)
DS1/DS3 YELLOW	A tributary yellow signal is being received. (Add/ Drop/Test Option Only)
ERROR	A bit, section, line, path, or VT parity error is detected; or a line, path, or VT FEBE is being received.
POINTER ADJ	A pointer adjustment is being received.

Extended Status

The red-yellow pair of ERROR lights on the front panel turn on when a variety of error conditions exist on the line. For more detail about the specific error types and frequency of occurrence, see the TEST SUMMARY, MAIN RESULTS, and ERROR ANALYSIS pages of the RESULTS menu. For more information on this topic, see page 3-174.

Setting the Beeper

You can set a beeper to sound every time a red status light turns on.

To enable or disable the beeper:

Press Menu Button	Select Menu Page	Highlight Parameter	Select Choice
UTILITY	MISC SETTINGS	Beeper	On
			Off

Setting SONET Transmit Parameters

This section describes how to set the transmit rate, specify the STS under test, set the payload mapping and content, and set the overhead bytes for SONET signals.

The CTS 710 SONET Test Set contains independent transmitter and receiver modules. One set of parameters controls the transmitter module and another set controls the receiver module. You can set the parameters that control the transmitter independently or you can choose to link the parameters to the receiver settings.

Steps for Setting Parameters

The sequence of steps for setting transmit parameters varies with the type of signal to be transmitted. The figures that follow show the sequence of steps required to set the transmit parameters of a SONET signal without a mapped tributary and a SONET signal with a mapped tributary. See page 3–89 for details on setting tributary signal parameters (for example DS3).



Figure 3–22: Sequence for Setting SONET Signal Parameters

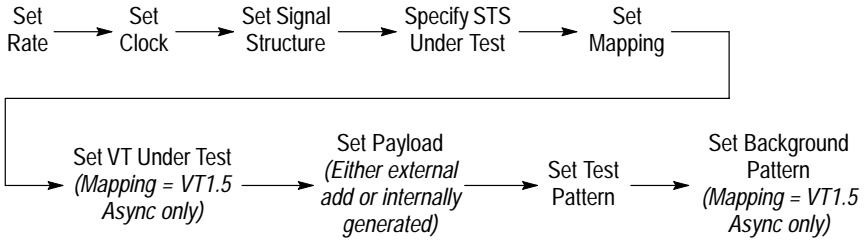

Figure 3–23: Sequence for Setting SONET Signal Parameters When Mapping a Tributary Signal

Setting the Transmit Rate

To set the transmit rate:

Press Menu Button	Select Menu Page	Highlight Parameter	Select Choice
TRANSMIT	TRANSMIT SETTINGS	Transmit Rate (see Figure 3–24 on page 3–65)	<i>as appropriate</i>

- Select **STS-1**, **STS-3**, **OC-1**, **OC-3**, or **OC-12** to transmit a SONET signal.
- Select **DS1** or **DS3** to transmit a tributary signal. See page 3–89 for details on setting tributary signal parameters.

NOTE. Even though there are output connectors for both SONET and tributary signals on the CTS 710 front panel, the CTS 710 can transmit only one type of signal at a time.

Independent Transmit and Receive Settings

Generally, you can set the transmit and receive settings independently. For example, you can receive an electrical signal at the STS-1

rate while simultaneously transmitting an optical signal at the OC-3 rate.

However, when working with tributary and DS_n signals, the transmit and receive parameters are not completely independent. You cannot transmit a DS1 signal and receive a DS3 signal. When working with tributary signals, you must set the mapping for transmit and receive to the same value or to **Bulk Fill No Mapping**. For example, you can transmit a DS1 signal and receive an OC-12 signal, but you must set the mapping of the received signal to either **Bulk Fill No Mapping** or **DS1**; it cannot be set to DS3.

Coupling Transmit and Receive Settings

If your application requires that the transmit settings and receive settings be identical, you can save time by coupling them together. After they are coupled, any change you make to a parameter on the TRANSMIT SETTINGS page will also be made to the corresponding setting in the RECEIVE SETTINGS page of the RECEIVE menu. The inverse is also true.

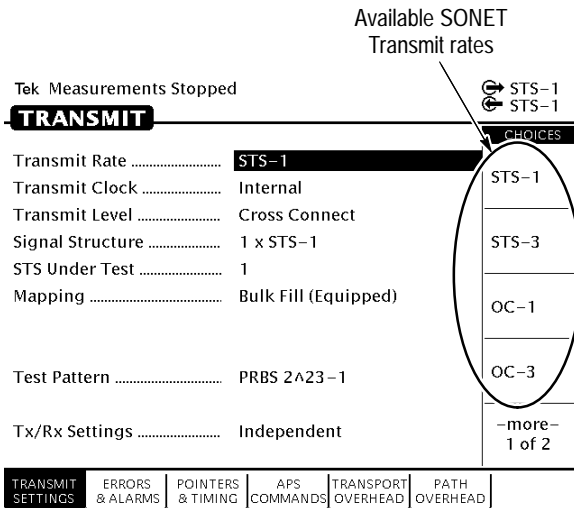

Figure 3-24: SONET Transmit Rates

To couple the transmit and receive settings together from the TRANSMIT SETTINGS page:

Press Menu Button	Select Menu Page	Highlight Parameter	Select Choice
TRANSMIT	TRANSMIT SETTINGS	Tx/Rx Settings	Coupled

NOTE. *When settings are coupled from the TRANSMIT SETTINGS page, the receive parameters are changed to match the transmit parameters. Conversely, when settings are coupled from the RECEIVE SETTINGS page, the transmit parameters are changed to match the receive parameters.*

Notice that the signal status icons, in the upper-right corner of the display, changed to reflect the coupling of the settings.

To change transmit and receive settings so that they are no longer coupled:

Press Menu Button	Select Menu Page	Highlight Parameter	Select Choice
TRANSMIT	TRANSMIT SETTINGS	Tx/Rx Settings	Independent

Notice that the signal status icons, in the upper-right corner of the display, changed to indicate that the settings are no longer coupled.

Through Mode

Use Through Mode to monitor a signal without changing it. In Through Mode, the rate and content of the transmitted signal is that of the received signal. You cannot make changes to pointers or timing, overhead bytes, or insert alarms or errors when the CTS 710 is in Through Mode. Through Mode does not perform clock recovery before retransmitting the recovered signal. Through Mode is used for nonintrusive performance monitoring of the active signal.

To put the CTS 710 into Through Mode:

Press Menu Button	Select Menu Page	Highlight Parameter	Select Choice
TRANSMIT	TRANSMIT SETTINGS	Tx/Rx Settings	Through Mode

To indicate when the CTS 710 is in Through Mode, the transmit and receive icons at the upper-right corner of the display have an arrow linking them together and the parameters on the TRANSMIT SETTINGS page are replaced by a message stating that the CTS 710 is in Through Mode (see Figure 3–25).

To take the CTS 710 out of Through Mode:

Press Menu Button	Select Menu Page	Highlight Parameter	Select Choice
TRANSMIT	TRANSMIT SETTINGS	Tx/Rx Settings	Independent
			Coupled

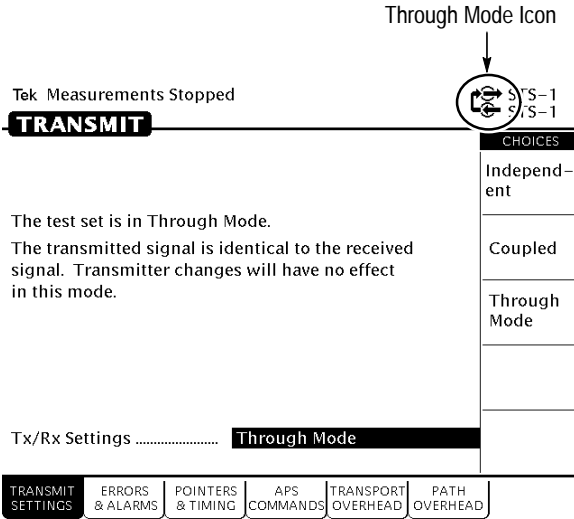

Figure 3-25: CTS 710 in Through Mode

Setting the Transmit Clock

To specify the transmit clock:

Press Menu Button	Select Menu Page	Highlight Parameter	Select Choice
TRANSMIT	TRANSMIT SETTINGS	Transmit Clock	Internal
			Recovered
			BITS

- Select **Internal** to set the transmit clock to the internal clock.
- Select **Recovered** to use the clock recovered from an incoming signal.

- Select **BITS** to use the clock signal from an external BITS reference. Attach the external BITS reference to the BITS connector on the rear panel.

Setting the Transmit Level

To specify the transmit level for electrical signals:

Press Menu Button	Select Menu Page	Highlight Parameter	Select Choice
TRANSMIT	TRANSMIT SETTINGS	Transmit Level	High
			XConnect

- Select **High** to set the line level to high.
- Select **XConnect** to set the line level to the cross-connect level.

Setting the Signal Structure

If you are transmitting an STS-3, OC-3, or OC-12 signal, you can specify whether the signal consists of STS-1 payloads or STS-3c payloads.

To specify the structure of an STS-3, OC-3, or OC-12 signal:

Press Menu Button	Select Menu Page	Highlight Parameter	Select Choice
TRANSMIT	TRANSMIT SETTINGS	Signal Structure	3 x STS-1
			1 x STS-3c
			12 x STS-1
			4 x STS-3c

- Select **3 x STS-1** to set the structure of an STS-3 or OC-3 signal to three STS-1 payloads.
- Select **1 x STS-3c** to set the structure of an STS-3 or OC-3 signal to one STS-3c payload.
- Select **12 x STS-1** to set the structure of an OC-12 signal to 12 STS-1 payloads.
- Select **4 x STS-3c** to set the structure of an OC-12 signal to four STS-3c payloads.

Specifying the STS to Test

If you are using a line rate other than the basic-level rates (STS-1 or OC-1), you must designate which STS to test.

To designate which STS to test:

Press Menu Button	Select Menu Page	Highlight Parameter	Select Choice
TRANSMIT	TRANSMIT SETTINGS	STS Under Test	<i>as appropriate</i>

Setting the Payload Mapping

To set the payload mapping:

Press Menu Button	Select Menu Page	Highlight Parameter	Select Choice
TRANSMIT	TRANSMIT SETTINGS	Mapping	Bulk Fill No Mapping (Equipped)
			Bulk Fill No Mapping (Unequipped)
			DS3
			VT 1.5 Async

NOTE. Some payload mappings require options that might not be installed in your CTS 710. Depending on the mapping you choose, you might need to set additional parameters.

- Select **Bulk Fill No Mapping (Equipped)** to fill the whole SPE with the test pattern specified and set the C2 byte to 1.
- Select **Bulk Fill No Mapping (Unequipped)** to fill the whole SPE with the test pattern specified and set the C2 byte to 0. An all-zeros pattern is the recommended test pattern for unequipped SPEs.
- Select **VT 1.5 Async** to map an externally supplied or an internally generated DS1 signal to the transmitted signal. See *Mapping a Tributary Signal* on page 3–72 for details.
- Select **DS3** to map an externally supplied or internally generated DS3 signal to the transmitted signal. See *Mapping a Tributary Signal* on page 3–72 for details.

Unequipped Payload Mapping

If you choose Bulk Fill No Mapping (Unequipped) payload mapping, the CTS 710 places the unequipped code in byte C2. You can transmit any of the pattern choices available with the Bulk Fill No Mapping (Equipped) payload mapping. However, the default pattern (all zeros prior to scrambling) is recommended.

When a SONET network element receives a signal with an unequipped channel, the network element should pass the signal through without making changes to it. This treatment should be consistent from one end of the network to the other. A loopback at the far end of the network would then allow a sole CTS 710 to transmit a PRBS across the payload channel and verify the error performance of the entire link from end to end.

Mapping a Tributary Signal (Add/Drop/Test Option Only)

To map a tributary signal, you first set the Mapping to the appropriate tributary mapping (as described in the previous section). When mapping a signal, you must also specify the payload. The payload can be either an external signal connected to the appropriate IN connector on the front panel or an internally generated signal.

Mapping a Tributary with VT1.5 Floating Async Payload Mapping

When you use the VT1.5 Floating Async mapping, you must also specify the virtual tributary under test and payload (see Figure 3–26).

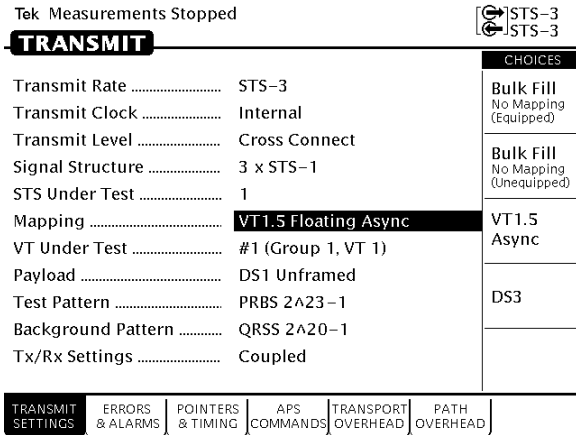

Figure 3-26: Mapping a Tributary Signal

To configure the CTS 710 for mapping a signal:

1. Set the mapping as follows:

Press Menu Button	Select Menu Page	Highlight Parameter	Select Choice
TRANSMIT	TRANSMIT SETTINGS	Mapping	VT 1.5 Async
			DS3

- Select **VT 1.5** to specify VT1.5 Floating Asynchronous mapping. An externally supplied or internally generated DS1 signal is mapped into the selected VT under test while the other 27 VTs contain a background pattern.
- Select **DS3** to map an externally supplied or internally generated DS3 signal to the transmitted signal.

2. If the Mapping is set to VT1.5 specify the VT under test as follows:

Press Menu Button	Select Menu Page	Highlight Parameter	Select Choice
		VT Under Test	VT #1
			VT #28
			Next
			Previous

- Select **VT #1** to specify the first virtual tributary.
 - Select **VT #28** to specify the last virtual tributary.
 - Select **Next** or **Previous** to change the selection to the next higher or next lower virtual tributary.
3. Specify the payload as follows:

Press Menu Button	Select Menu Page	Highlight Parameter	Select Choice
		Payload	<i>as appropriate</i>

- Select **DS1 Ext Add** to map a DS1 signal, connected to the DS1 IN connector on the CTS 710 front panel, into the payload of the selected virtual tributary.
- Select **DS1 Unframed** to map an internally generated, unframed DS1 signal into the payload of the selected virtual tributary.
- Select **DS1 SF (D4)** to map an internally generated DS1 signal, with D4 SuperFrame framing, into the payload of the selected virtual tributary.
- Select **DS1 ESF** to map an internally generated DS1 signal, with Extended SuperFrame framing, into the payload of the selected virtual tributary.

- Select **DS3 Ext Add** to map a DS3 signal, connected to the DS3 Input connector on the CTS 710 front panel, into the STS payload.
- Select **DS3 Unframed** to map an internally generated, unframed DS3 signal into the STS payload.
- Select **DS3 C-bit** to map an internally generated DS3 signal, with C-bit framing, into the payload of the selected virtual tributary.
- Select **DS3 M13** to map an internally generated DS3 signal, with M13 framing, into the payload of the selected virtual tributary.

Setting the Test Pattern

You can select a test pattern to transmit in the SPE.

To specify the test pattern to transmit:

Press Menu Button	Select Menu Page	Highlight Parameter	Select Choice
TRANSMIT	TRANSMIT SETTINGS	Test Pattern	<i>as appropriate</i>

- Select **1 in 8** to set the test pattern to 01000000.
- Select **3 in 24** to set the test pattern to 01000100 00000000 00000100.
- Select **User Word 8 bit**, **User Word 16 bit**, or **User Word 24 bit** to set a test pattern different from the preset choices. If you choose User Word, the test pattern description changes to display the byte selected.

If you select User Word 8 bit/16 bit/24 bit for the test pattern, set the value of the User Word as follows:

1. Set the contents of the User Word Byte(s) as follows (see Figure 3–27):

Press Menu Button	Select Menu Page	Highlight Parameter	Select Choice
		Test Pattern	Set to 00000000
			Set to 11111111
			Default 10101010
			EDIT BYTE/ Edit XX bits

2. Select **EDIT BYTE/Edit XX bits** to specify a value different from the preset choices.
3. Select **Predefined Patterns** if you decide to use the standard patterns.
4. Select **DONE** when you are finished editing the byte.

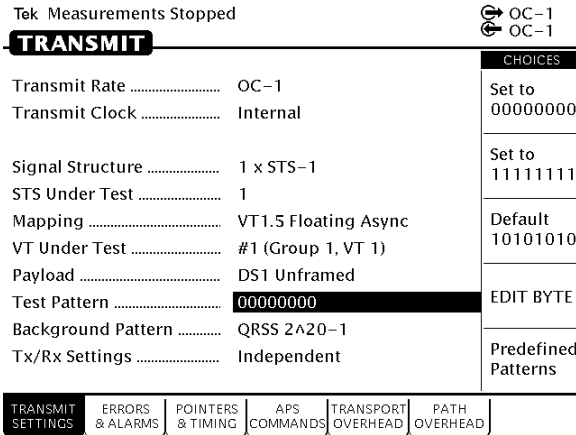

Figure 3-27: Editing the User Word Byte

Setting Overhead Bytes

To stress test a network, you sometimes need to simulate errors or alarms. Use the controls on the **ERRORS & ALARMS** page of the **TRANSMIT** menu to simulate errors or alarms. As an alternative, you can edit the transport overhead and path overhead bytes directly to simulate errors, alarms, and create other stress conditions. This section describes how to use the **TRANSPORT OVERHEAD** and **PATH OVERHEAD** pages to edit overhead bytes.

How to Edit an Overhead Byte

The following procedure applies to editing either transport overhead or path overhead bytes. Transport overhead is given as an example.

To edit overhead bytes:

1. Display the transport overhead as follows:

Press Menu Button	Select Menu Page	Highlight Parameter	Select Choice
TRANSMIT	TRANSPORT OVERHEAD		

Because only three columns of overhead are displayed at one time, you must specify which columns you want to edit.

2. Select the columns you wish to edit as follows:

Press Menu Button	Select Menu Page	Highlight Parameter	Select Choice
		Showing Overhead for	<i>as appropriate</i>

3. Turn the knob to highlight the byte you want to edit. See Figure 3–28.

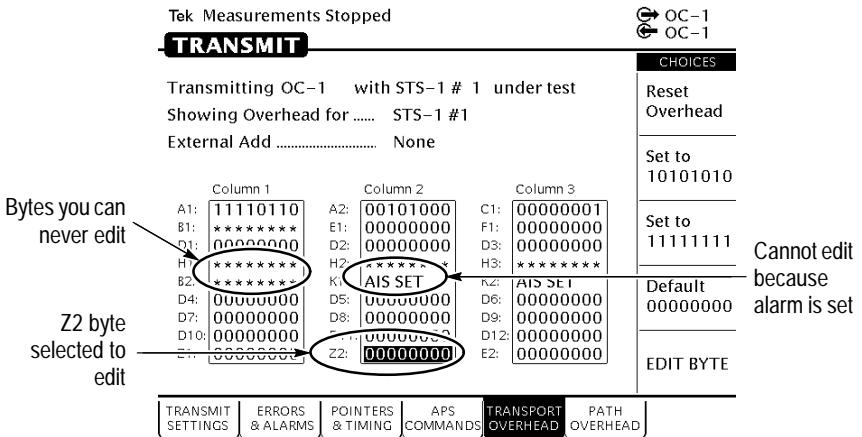

Figure 3-28: Editing the Z2 Transmit Overhead Byte

There are several ways to edit the byte:

- Select **Reset Overhead** to set all bytes in the overhead to their individual default values. However, Reset Overhead does not remove simulated error conditions that have been set using controls in the ERRORS & ALARMS page. A simulated error condition overrides the default value of the overhead byte that signals that particular error condition.
 - Select **Default (XXXXXXXX)** to set the selected byte to its default value. The specific default value depends on the selected byte and on the rate and structure of the signal.
 - Select **EDIT BYTE** to define the byte as a value different from the preset choices.
4. To edit the selected byte to a value of your choice:

Press Menu Button	Select Menu Page	Highlight Parameter	Select Choice
			EDIT BYTE

- Define your own byte with the buttons next to **1** and **0**. Use the left and right arrow buttons to move the cursor from one bit to the next. See Figure 3–29.
- When you finish editing the byte, select **DONE**.

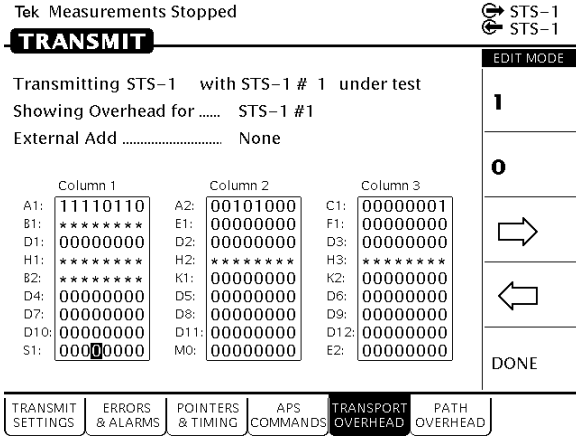

Figure 3–29: Editing an Overhead Byte

Editing the V5 Byte

To edit the V5 byte (VT1.5 Mapping Only):

Press Menu Button	Select Menu Page	Highlight Parameter	Select Choice
TRANSMIT	PATH OVERHEAD	Overhead View	VT1.5 Overhead

Only bits 5, 6, and 7 (the signal label bits) of the V5 byte are editable. See Table 3–7.

Table 3–7: Choices for Bits 5, 6, and 7 of the V5 Byte

Choice
Unequip (000)
Equipped (001)
Async (010)
Bit-Sync (011)
Byte-Sync (100)
Reserved (101)
TSS4 (110)
VT-AIS

Bytes You Cannot Edit

Certain bytes in the transport overhead and path overhead cannot be edited in the TRANSPORT OVERHEAD or PATH OVERHEAD pages. These uneditable bytes have calculated values that are based on the payload and signal structure (see Table 3–8).

Table 3–8: Overhead Bytes That Cannot Be Edited

Overhead Byte	Function
B1	Section level parity byte
B2	Line level parity byte
B3	Path level parity byte
G1	Path status
H1, H2, H3	Identify location of payload
H4	Multiframe indicator

The bytes that cannot be edited are marked with a line of asterisks on the TRANSPORT OVERHEAD or PATH OVERHEAD pages (see Figure 3–28 on page 3–79).

In addition, there are bytes you may not be able to edit depending on parameter settings in the CTS 710. As shown in Figure 3–28, a short text string replaces the binary values in the byte field of the TRANSPORT OVERHEAD and PATH OVERHEAD pages when a byte cannot be edited. Table 3–9 shows the affected bytes, the text string, and a description of the parameter setting that prevents the byte from being edited.

Table 3–9: Bytes You Cannot Edit Due to Parameter Settings

Transport and Path Overhead Byte(s)	Text String that Replaces the Binary Values	Parameter Setting Affecting Byte-Edit Capability
A1, A2	LOF SET	Loss of Frame Failure is being simulated
D1, D2, D3	EXT ADD	Section Data Communication Channel External Add is enabled
K1, K2	LAIS SET	Line AIS is being simulated
	FERF SET	Line FERF is being simulated
D4, D5, D6, D7, D8, D9, D10, D11, D12	EXT ADD	Line Data Communication Channel External Add is enabled
S1	FEBE SET	Line FEBE is being simulated
G1	FERF SET	Path FERF is being simulated
	FEBE SET	Path FEBE is being simulated
All path overhead bytes set to ones	PAIS SET	Path AIS is being simulated

Editing the J1 Path Trace Byte

The J1 Path Trace Byte carries a fixed-length, 64-byte string intended for sending user messages. The Path Trace Byte is a string

consisting of ASCII characters (rather than the ones and zeros used to edit the other overhead bytes).

To edit the J1 Path Trace Byte:

1. Display the Path Trace Byte as follows:

Press Menu Button	Select Menu Page	Highlight Parameter	Select Choice
TRANSMIT	PATH OVERHEAD	J1 byte	Reset Overhead
			Null Trace
			Default Trace
			User Trace
			EDIT TRACE

The text string USER is shown in place of the actual byte value. There are five ways you can change the Path Trace message.

- Select **Reset Overhead** to set all bytes in the path overhead to their default values.

NOTE. *Reset Overhead does not remove simulated error conditions that have been set using controls in the ERRORS & ALARMS page.*

- Select **Null Trace** to set all the J1 bytes in the string to the null character.
 - Select **Default Trace** to set the J1 byte string to the default string “Tektronix CTS 710 SONET Test Set, hello how are you?”
 - Select **User Trace** to set the J1 byte string to a string you can enter using the EDIT TRACE function.
 - Select **EDIT TRACE** to define your own text string.
2. Select **EDIT TRACE** to edit the path trace message (see Figure 3–30).

The string can contain a maximum of 64 characters, including spaces.

3. Select **DONE** when you have completed the entering string.

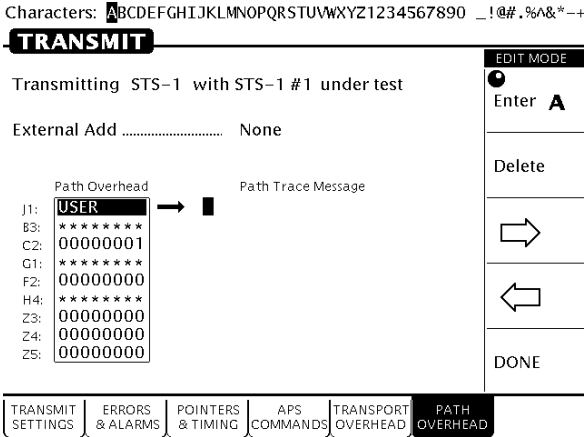

Figure 3-30: Editing the J1 Path Trace Byte

Adding DCC and User Channel Overhead Bytes

You can add data generated by an external protocol analyzer into the Data Communication Channel (DCC) and User Channel. The data from the protocol analyzer is added through the Overhead Add/Drop Port located on the rear panel. See *Appendix G* for detailed information on the port pin assignments.

To add external data into the DCC:

1. Connect an external protocol analyzer to the CTS 710 using the Overhead Add/Drop Port on the rear panel of the CTS 710.

2. To configure the CTS 710 to add the external data bytes:

Press Menu Button	Select Menu Page	Highlight Parameter	Select Choice
TRANSMIT	TRANSPORT OVERHEAD	External Add	None
			D1–D3
			D4–D12
			F1

- Select **None** if you do not want to add external data.
- Select **D1–D3** to add data, generated by an external protocol analyzer, to the D1–D3 bytes of the DCC.
- Select **D4–D12** to add data, generated by an external protocol analyzer, to the D4–D12 bytes of the DCC.
- Select **F1** to add data, generated by an external protocol analyzer, to the F1 byte of the DCC.

As soon as you select which bytes to add data to, the CTS 710 displays the words EXT ADD as the value for the selected bytes (see Figure 3–31).

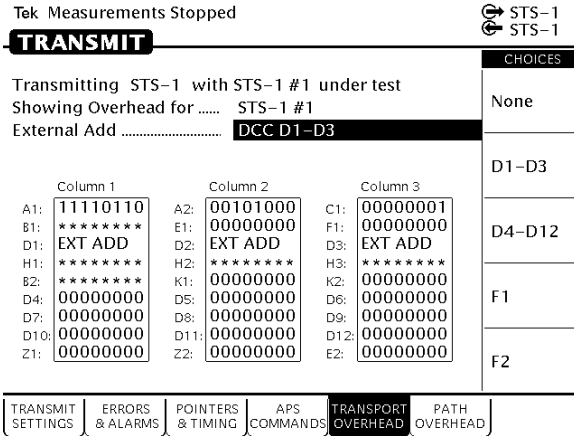

Figure 3-31: Adding Data into the DCC

To add external data into the User Channel:

1. Connect an external protocol analyzer to the CTS 710 using the Overhead Add/Drop Port on the rear panel of the CTS 710.
2. To configure the CTS 710 to add the external data byte:

Press Menu Button	Select Menu Page	Highlight Parameter	Select Choice
TRANSMIT	PATH OVERHEAD	External Add	None
			F2

- Select **None** if you do not want to add external data.
- Select **F2** to add data, generated by an external protocol analyzer, to the User Channel.

As soon as you select F2, the CTS 710 displays the words EXT ADD as the value for F2 (see Figure 3-32).

Tek Measurements Stopped ↻ STS-1
↻ STS-1

TRANSMIT

Transmitting STS-1 with STS-1 # 1 under test

Overhead View STS Path Overhead

External Add **F2 User Byte**

Path Overhead		Path Trace Message
J1:	USER	
B3:	*****	
C2:	00000010	
G1:	*****	
F2:	EXT ADD	
H4:	*****	
Z3:	00000000	
Z4:	00000000	
Z5:	00000000	

CHOICES

None

D1-D3

D4-D12

F1

F2

TRANSMIT SETTINGS
ERRORS & ALARMS
POINTERS & TIMING
APS COMMANDS
TRANSPORT OVERHEAD
PATH OVERHEAD

Figure 3-32: Adding Data into the User Channel

Setting Tributary Signal Transmit Parameters

This section describes how to set the transmit rate, transmit clock, line code, framing, and test pattern for a tributary signal.

Steps for Setting Parameters

The sequence of steps for setting transmit parameters varies depending on the type of signal to be transmitted. Figure 3–33 shows the sequence of steps required to set the transmit parameters for a tributary signal (for example, DS3).



Figure 3–33: Sequence for Setting Tributary Signal Parameters

Setting the Transmit Rate

To set the transmit rate:

Press Menu Button	Select Menu Page	Highlight Parameter	Select Choice
TRANSMIT	TRANSMIT SETTINGS	Transmit Rate (see Figure 3–34)	DS1
			DS3

- Select **DS1** or **DS3** to transmit a tributary rate signal.

***NOTE.** The CTS 710 can transmit only one signal rate at a time. The CTS 710 can transmit either a SONET signal or a tributary signal, but not both at the same time.*

Independent Transmit and Receive Settings

Generally, you can set the transmit and receive settings independently. For example, you can receive an electrical signal at the STS-1 rate while simultaneously transmitting an optical signal at the DS1 rate.

However, when working with tributary and DS_n signals, the transmit and receive parameters are not completely independent. You cannot transmit a DS1 signal and receive a DS3 signal. When working with tributary signals, you must set the mapping for transmit and receive to the same value or to **Bulk Fill No Mapping**. For example, you can transmit a DS1 signal and receive an OC-12 signal, but you must set the mapping of the received signal to either **Bulk Fill No Mapping** or **VT1.5**; it cannot be set to DS3.

Coupling Transmit and Receive Settings

If your application requires that the transmit settings and receive settings be identical, you can save time by coupling them together.

After they are coupled, any change you make to a parameter on the TRANSMIT SETTINGS page will also be made to the corresponding setting in the RECEIVE SETTINGS page of the RECEIVE menu. The inverse is also true.

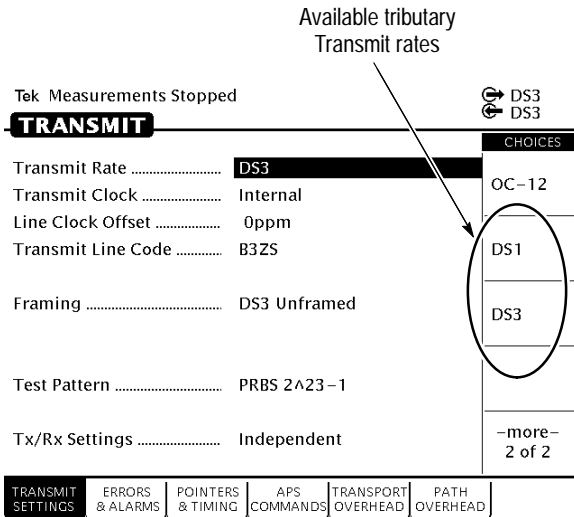

Figure 3-34: Tributary Transmit Rates

To couple the transmit and receive settings together from the TRANSMIT SETTINGS page:

Press Menu Button	Select Menu Page	Highlight Parameter	Select Choice
TRANSMIT	TRANSMIT SETTINGS	Tx/Rx Settings	Coupled

NOTE. When settings are coupled from the *TRANSMIT SETTINGS* page, the receive parameters are changed to match the transmit parameters. Conversely, when settings are coupled from the *RECEIVE SETTINGS* page, the transmit parameters are changed to match the receive parameters.

Notice that the signal status icons, in the upper-right corner of the display, changed to reflect the coupling of the settings.

To change transmit and receive settings so that they are no longer coupled:

Press Menu Button	Select Menu Page	Highlight Parameter	Select Choice
TRANSMIT	TRANSMIT SETTINGS	Tx/Rx Settings	Independent

Notice that the signal status icons, in the upper-right corner of the display, changed to indicate that the settings are no longer coupled.

Setting the Transmit Clock

To specify the transmit clock:

Press Menu Button	Select Menu Page	Highlight Parameter	Select Choice
TRANSMIT	TRANSMIT SETTINGS	Transmit Clock	Internal
			Recovered
			External BITS
			External DSn

- Select **Internal** to set the transmit clock to the internal clock.

- Select **Recovered** to use the clock recovered from an incoming signal.
- Select **External BITS** to use the clock signal from an external BITS reference. Attach the external BITS reference to the BITS connector on the rear panel.
- Select **External DS_n** to use an external DS1/DS3 clock. Attach the clock to the external clock connector located on the rear panel.

Setting the Line Clock Offset

To specify the line clock offset:

Press Menu Button	Select Menu Page	Highlight Parameter	Select Choice
TRANSMIT	TRANSMIT SETTINGS	Line Clock Offset	Max +100ppm
			Stress +1.0ppm
			Stress -1.0ppm
			USER DEFINED

- Select **USER DEFINED** to specify a clock offset different from the preset choices.

Setting the Transmit Line Code

To specify the transmit line code for the tributary signal:

Press Menu Button	Select Menu Page	Highlight Parameter	Select Choice
TRANSMIT	TRANSMIT SETTINGS	Transmit Line Code	<i>as appropriate</i>

- Select **AMI** to set the line code to Alternate Mark Inversion.
- Select **B8ZS** to set the line code to Binary 8-Zero Substitution.
- B3ZS (Binary 3-Zero Substitution) is the only available line code for the DS3 rate.

The line code available for selection depends on the selected transmit rate. The available line codes and their associated rates are listed in Table 3–10.

Table 3–10: Tributary Rate Line Codes

Transmit Rate	Line Codes Available
DS1	AMI
	B8ZS
DS3	B3ZS

Specifying the Framing

The framing choices available depend on the selected transmit rate.

To set the framing for a DS1 signal:

Press Menu Button	Select Menu Page	Highlight Parameter	Select Choice
TRANSMIT	TRANSMIT SETTINGS	Framing	DS1 Unframed
			DS1 SF (D4)
			DS1 ESF

- Select **DS1 Unframed** to transmit a signal without framing.
- Select **DS1 SF (D4)** to transmit a signal with Superframe framing.

- Select **DS1 ESF** to transmit a signal with Extended Superframe framing.

To set the framing for a DS3 signal:

Press Menu Button	Select Menu Page	Highlight Parameter	Select Choice
TRANSMIT	TRANSMIT SETTINGS	Framing	DS3 Unframed
			DS3 C-bit
			DS3 M13

- Select **DS3 Unframed** to transmit a signal without framing.
- Select **DS3 C-bit** to transmit a signal with C-bit framing.
- Select **DS3 M13** to transmit a signal with M13 framing.

Specifying the Test Pattern

You can select a test pattern to transmit in the tributary signal.

To specify the test pattern to transmit:

Press Menu Button	Select Menu Page	Highlight Parameter	Select Choice
TRANSMIT	TRANSMIT SETTINGS	Test Pattern	PRBS 2 ²³ -1
			PRBS 2 ²⁰ -1
			PRBS 2 ¹⁵ -1
			QRSS 2 ²⁰ -1
			1 in 8
			All Ones
			All Zeros
			User Word 8 bit
			User Word 16 bit
			User Word 24 bit

- Select **QRSS 2²⁰-1** to send a Quasi-Random Signal Source sequence as the test pattern (DS1 only).
- Select **1 in 8** to set the test pattern to 01000000.
- Select **3 in 24** to set the test pattern to 01000100 00000000 00000100.
- Select **User Word 8 bit**, **User Word 16 bit**, or **User Word 24 bit** to set a test pattern different from the preset choices. If you choose one of the User Word choices, the test pattern description changes to User Defined Byte.

If you select User Word 8 bit/16 bit/24 bit for the test pattern, set the value of the User Word as follows:

1. Set the contents of the User Word as follows:

Press Menu Button	Select Menu Page	Highlight Parameter	Select Choice
		Test Pattern	Set to 00000000
			Set to 11111111
			Default 10101010
			EDIT BYTE/ Edit XX bits

2. Select **EDIT BYTE/Edit XX bits** to specify a value different from the preset choices (see Figure 3–35).
3. Select **Predefined Patterns** if you decide to use the standard patterns.
4. Select **DONE** when you are finished editing the byte.

Tek Measurements Stopped

TRANSMIT

DS3
DS3

TRANSMIT		CHOICES
Transmit Rate	DS3	Set to 00000000
Transmit Clock	Internal	
Line Clock Offset	0ppm	Set to 11111111
Transmit Line Code	B3Z5	
Framing	DS3 Unframed	Default 10101010
Test Pattern	00000000	EDIT BYTE
Tx/Rx Settings	Independent	Predefined Patterns

TRANSMIT SETTINGS ERRORS & ALARMS POINTERS & TIMING APS COMMANDS TRANSPORT OVERHEAD PATH OVERHEAD

Figure 3–35: Editing the User Word

Setting SONET Receive Parameters

This section describes how to manually set the receive line rate, define the STS under test, set the payload mapping and content, check the received optical signal power, and view the overhead bytes.

The CTS 710 SONET Test Set contains independent transmit and receive modules. One set of parameters controls the transmit module and a separate set controls the receive module. You can set the receive parameters independent of the transmit parameters or you can choose to link them to the transmit settings.

Pressing AUTOSCAN sets the receive parameters automatically based on the received signal.

Steps for Setting Parameters

The sequence of steps for setting receive parameters varies with the type of signal to be received. Figure 3–36 shows the sequence of steps required to set the receive parameters for a SONET signal without demapping a tributary signal. Figure 3–37 shows the steps required to set the receive parameters for a SONET signal when demapping a tributary signal. See page 3–89 for details on setting tributary signal parameters (for example DS3).



Figure 3–36: Sequence for Setting SONET Signal Parameters

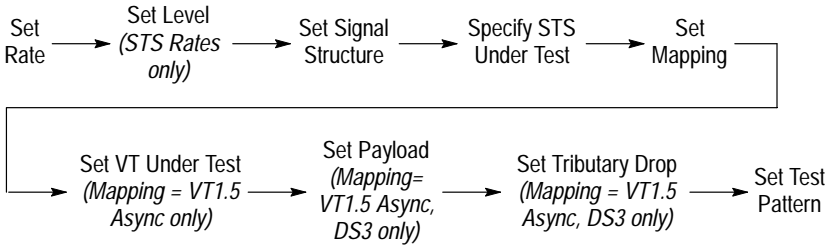

Figure 3–37: Sequence for Setting SONET Signal Parameters When Demapping a Tributary Signal

Setting the Receive Rate

To set the receive rate:

Press Menu Button	Select Menu Page	Highlight Parameter	Select Choice
RECEIVE	RECEIVE SETTINGS (see Figure 3–38)	Receive Rate	<i>as appropriate</i>

- Select **STS-1**, **STS-3**, **OC-1**, **OC-3**, or **OC-12** to receive a SONET signal.
- Select **DS1**, **DS3**, or **DS3→DS1** to receive a tributary rate signal. See page 3–121 for details on setting tributary signal parameters.

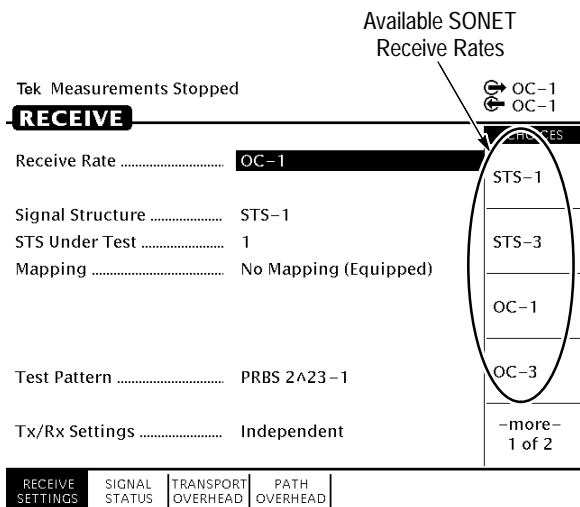

Figure 3-38: SONET Receive Rates

Independent Receive and Transmit Settings

Generally, you can set the receive and transmit settings independently. For example, you can receive an electrical signal at the STS-1 rate while simultaneously transmitting an optical signal at the OC-3 rate.

However, when working with tributary signals, the receive and transmit parameters are not completely independent. You cannot receive a DS1 signal and transmit a DS3 signal. When working with tributary signals, you must set the mapping for receive and transmit to the same value or to **Bulk Fill No Mapping**. For example, you can receive a DS1 signal and transmit an OC-12 signal, but you must set the mapping of the transmitted signal to either **Bulk Fill No Mapping** or **DS1**; it cannot be set to DS3.

Coupling Receive and Transmit Settings

If your application requires that the receive settings and transmit settings be identical, you can save time by coupling them together. After they are coupled, any change you make to a parameter on the

RECEIVE SETTINGS page will also be made to the corresponding setting in the TRANSMIT SETTINGS page of the RECEIVE menu. The inverse is also true.

To couple the receive and transmit settings together from the RECEIVE SETTINGS page:

Press Menu Button	Select Menu Page	Highlight Parameter	Select Choice
RECEIVE	RECEIVE SETTINGS	Tx/Rx Settings	Coupled

NOTE. When settings are coupled from the RECEIVE SETTINGS page, the transmit parameters are changed to match the receive parameters. Conversely, when settings are coupled from the TRANSMIT SETTINGS page, the receive parameters are changed to match the transmit parameters.

To change receive and transmit settings so that they are no longer coupled:

Press Menu Button	Select Menu Page	Highlight Parameter	Select Choice
RECEIVE	RECEIVE SETTINGS	Tx/Rx Settings	Independent

Notice that the signal status icons, in the upper-right corner of the display, changed to indicate that the settings are no longer coupled.

NOTE. When the incoming line rate changes, a valid LOS must occur between the old and new line rates; otherwise, the CTS 710 might lose pattern lock and display an LOS or LOF status. If this occurs, reselect the correct Receive line rate after the change or initiate a valid LOS (for example, disconnect and reconnect the received signal or assert LOS at the source).

Setting the Receive Level

To specify the receive level for electrical signals:

Press Menu Button	Select Menu Page	Highlight Parameter	Select Choice
RECEIVE	RECEIVE SETTINGS	Receive Level	XConnect
			Low
			High
			Monitor

- Select **XConnect** to set the line level to the cross-connect level.
- Select **Low** to set the line level to low.
- Select **High** to set the line level to high.
- Select **Monitor** to set the line level to the monitor level.

Setting the Signal Structure

If you are receiving an STS-3, OC-3 or OC-12 signal, you can specify whether the signal consists of STS-1 payloads or STS-3c payloads.

To specify the structure of a received STS-3, OC-3, or OC-12 signal:

Press Menu Button	Select Menu Page	Highlight Parameter	Select Choice
RECEIVE	RECEIVE SETTINGS	Signal Structure	STS-1
			STS-3c

Specifying Which STS to Test

If you are using a line rate other than the SONET basic-level rates STS-1 or OC-1, you must select one STS to test.

To designate which STS to test:

Press Menu Button	Select Menu Page	Highlight Parameter	Select Choice
RECEIVE	RECEIVE SETTINGS	STS Under Test	<i>as appropriate</i>

Setting the Mapping

You can specify whether the payload contains live data or not. If you know the mapping of the received signal, you can specify what the mapping is on the RECEIVE SETTINGS page.

NOTE. *The CTS 710 cannot demap a tributary signal and transmit a tributary signal at the same time.*

To specify the mapping of the received signal:

Press Menu Button	Select Menu Page	Highlight Parameter	Select Choice
RECEIVE	RECEIVE SETTINGS	Mapping	Bulk Fill No Mapping (Equipped)
			Bulk Fill No Mapping (Unequipped)
			DS3
			VT1.5

NOTE. Some mappings require options that might not be installed in your CTS 710. Depending on the mapping you choose, you might need to set additional parameters.

- Select **Bulk Fill No Mapping (Equipped)** to receive an SPE that is filled with the test pattern specified (on the Test Pattern line) and where the C2 byte is set to 1.
- Select **Bulk Fill No Mapping (Unequipped)** to receive an SPE that is filled with the test pattern specified (on the Test Pattern line) and where the C2 byte is set to 0.
- Select **VT 1.5 Async** to demap a DS1 signal from the received signal. See *Demapping a Tributary Signal* for details.

NOTE. *The CTS 710 will report errors incorrectly when the receive mapping is set to VT 1.5 Async but the received signal does not actually contain any tributary signals. For example, if the transmitted signal is an STS-3 signal using a PRBS for the payload and the receive mapping is set to VT 1.5 Async, the CTS 710 will report errors for VT AIS, VT FERF, VT FEBE, VT BIP, and VT LOP. This occurs only when the received signal does not contain a tributary signal but the CTS 710 is configured to receive a signal that contains a tributary. This applies only to CTS 710s with the Add/Drop/Test Option.*

- Select **DS3** to demap a DS3 signal from the received signal. See *Demapping a Tributary Signal* for details.
- Select **DS3→DS1** to demap a DS1 signal from the received signal. See *Demultiplexing a DS1 from a DS3 Mapped in a SONET Signal* for details.

Demultiplexing a DS1 from a DS3 Mapped in a SONET Signal (Add/Drop/Test Option Only)

To demultiplex a DS1 signal from a SONET signal that uses DS3 mapping:

1. After setting the SONET signal mapping to DS3→DS1 Demux, specify the DS3 mapping as follows:

Press Menu Button	Select Menu Page	Highlight Parameter	Select Choice
RECEIVE	RECEIVE SETTINGS	DS3 Framing	DS3 C-bit
			DS3 M13

2. Specify the DS1 User Test as follows:

Press Menu Button	Select Menu Page	Highlight Parameter	Select Choice
		DS1 Under Test	DS1 #1
			DS1 #28
			Next
			Previous

- Select **DS1 #1** to specify the first DS1 signal.
- Select **DS1 #28** to specify the last DS1 signal.
- Select **Next** to change the selection to the next higher DS1 signal.
- Select **Previous** to change the selection to the next lower DS1 signal.

3. Specify the DS1 Framing as follows:

Press Menu Button	Select Menu Page	Highlight Parameter	Select Choice
		Framing	DS1 Unframed
			DS1 SF (D4)
			DS1 ESF

- Select **DS1 Unframed** to demultiplex an unframed DS1 signal or a DS1 signal whose framing is unknown.
- Select **DS1 SF (D4)** to demultiplex a DS1 signal in D4 Superframe format.
- Select **DS1 ESF** to demultiplex a DS1 signal in Extended Superframe format.

4. To drop the DS1 signal to the front panel connectors:

Press Menu Button	Select Menu Page	Highlight Parameter	Select Choice
		Tributary Drop	On

5. Specify the received test pattern as follows:

Press Menu Button	Select Menu Page	Highlight Parameter	Select Choice
		Test Pattern	PRBS 2 ²³ -1
			PRBS 2 ²⁰ -1
			PRBS 2 ¹⁵ -1
			QRSS 2 ²⁰ -1
			All Ones
			All Zeros
			1 in 8
			3 in 24
			User Word 8 Bit
			User Word 16 Bit
			User Word 24 Bit
			Unknown

- Select **User Word 8 Bit**, **User Word 16 Bit**, or **User Word 24 Bit** to receive test patterns different from the preset choices. If you choose User Word, the test pattern description changes to show the selected bit pattern. Edit the bits of the word as needed.
- Select **Unknown** when you do not know what test pattern is being transmitted or when the test pattern is not stable.

The demultiplexed DS1 signal will be delivered to the DS1 OUT connector on the front panel.

Demapping a Tributary Signal (Add/Drop/Test Option Only)

To demap and test a tributary signal, you set Mapping to the appropriate tributary mapping.

NOTE. The CTS 710 cannot demap a tributary signal and transmit a tributary signal at the same time.

When you use tributary signal mapping, you must also specify the virtual tributary under test and payload (see Figure 3–39).

Tek Measurements Stopped

↻ STS-1
↻ STS-1

RECEIVE		CHOICES
Receive Rate	STS-1	No Mapping (Equipped)
Receive Level	Cross Connect	No Mapping (UnEquipped)
Signal Structure	STS-1	VT1.5 Async
STS Under Test	1	DS3
Mapping	VT1.5 Floating Async	DS3 -> DS1 Demux
VT Under Test	#1 (Group 1, VT 1)	
Payload	DS1 Unframed	
Tributary Drop	Off	
Test Pattern	PRBS 2^23-1	
Tx/Rx Settings	Independent	

RECEIVE SETTINGS SIGNAL STATUS TRANSPORT OVERHEAD PATH OVERHEAD

Figure 3–39: Setting Tributary Mapping

To specify the VT Under Test and set the payload:

- Specify the VT Under Test as follows:

Press Menu Button	Select Menu Page	Highlight Parameter	Select Choice
RECEIVE	RECEIVE SETTINGS	VT Under Test	<i>as appropriate</i>

- Select **VT #1** to specify the first virtual tributary.
- Select **VT #28** to specify the last virtual tributary.
- Select **Next** to change the selection to the next higher virtual tributary.
- Select **Previous** to change the selection to the next lower virtual tributary.

7. Specify the payload as follows:

Press Menu Button	Select Menu Page	Highlight Parameter	Select Choice
		Payload	<i>as appropriate</i>

- Select **DS1 Unframed** to demap an unframed DS1 signal or a DS1 signal whose framing is unknown.
- Select **DS1 SF (D4)** to demap a DS1 signal (in D4 Superframe format) from the payload of the selected virtual tributary.
- Select **DS1 ESF** to demap a DS1 signal (in Extended Superframe format) from the payload of the selected virtual tributary.
- Select **DS3 Unframed** to demap an unframed DS3 signal or a DS3 signal whose framing is unknown.
- Select **DS3 C-bit** to demap a DS3 signal with C-bit framing.
- Select **DS3 M13** to demap a DS3 signal with M-13 framing.

Dropping a Tributary Signal

To drop a signal it must be demapped, as described previously, and you must turn on Tributary Drop.

To turn on Tributary Drop:

Press Menu Button	Select Menu Page	Highlight Parameter	Select Choice
RECEIVE	RECEIVE SETTINGS	Tributary Drop	Off
			On AMI
			On B8ZS

- Select **On** to drop the signal specified on the Payload line. The signal will be dropped to the appropriate OUT connector on the front panel.
- Select **On AMI** to drop a DS1 signal using Alternate Mark Inversion coding.
- Select **On B8ZS** to drop a DS1 signal using Binary Eight Zero Substitution coding.

Setting the Test Pattern

To specify the test pattern that will be received:

1. Specify the received test pattern using the following procedure:

Press Menu Button	Select Menu Page	Highlight Parameter	Select Choice
RECEIVE	RECEIVE SETTINGS	Test Pattern	PRBS 2 ²³ -1
			PRBS 2 ²⁰ -1
			PRBS 2 ¹⁵ -1
			PRBS 2 ⁰⁹ -1
			All Ones
			All Zeros
			User Word
			Unknown

- Select **User Word** to receive a test pattern different from the preset choices. If you choose User Word, the test pattern description changes to User Defined Byte.
 - Select **Unknown** when you do not know what test pattern is being transmitted or when the test pattern is not stable.
2. Select the line containing the byte to set the value of the User Defined Byte.
 3. Select a preset choice or select **EDIT BYTE** to enter a byte string different from the preset choices.

When you are finished editing the byte, select **DONE**.

Unequipped Payload Mapping

If you choose Bulk Fill No Mapping (Unequipped) payload mapping, the CTS 710 receiver expects to find the unequipped code in byte C2. The received payload is ignored except for parity checks.

Checking Received Optical Power or Received Peak Voltage

To check the optical power or the peak voltage of the received SONET signal:

Press Menu Button	Select Menu Page	Highlight Parameter	Select Choice
RECEIVE	SIGNAL STATUS	<i>none</i>	<i>none</i>

NOTE. *The CTS 710 may take several seconds to respond when a signal is connected to the input.*

If Receive Rate, on the RECEIVE SETTINGS page, is set to an optical rate, the SIGNAL STATUS page displays the received optical power. If Receive Rate is set to an electrical rate, the SIGNAL STATUS page displays the received peak voltage.

The optical power of the received signal is displayed in dBm (see Figure 3-40). The peak voltage of the received signal is displayed in volts. The SIGNAL STATUS page does not display results for tributary signals.

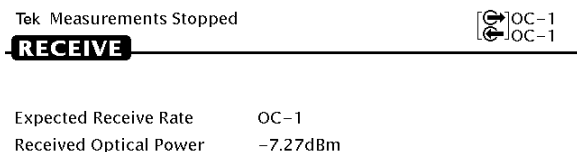

Figure 3-40: Displaying Received Optical Power

Viewing Overhead Bytes

This section describes how to use the TRANSPORT OVERHEAD and PATH OVERHEAD pages to view overhead bytes. The display updates about once per second to track changes in the overhead. At any time, you can pause the updating process to analyze the bytes.

Viewing Transport Overhead Bytes

To view transport overhead bytes:

1. Display the transport overhead as follows:

Press Menu Button	Select Menu Page	Highlight Parameter	Select Choice
RECEIVE	TRANSPORT OVERHEAD	<i>none</i>	<i>none</i>

If you are receiving a line rate higher than the SONET basic-level rates STS-1 or OC-1, you must indicate which overhead, at the STS-1 level, you want to display.

2. Select the columns you wish to display as follows:

Press Menu Button	Select Menu Page	Highlight Parameter	Select Choice
		Showing Overhead for	<i>as appropriate</i>

Viewing Path Overhead Bytes

To view path overhead bytes:

1. Display the path overhead as follows:

Press Menu Button	Select Menu Page	Highlight Parameter	Select Choice
RECEIVE	TRANSPORT OVERHEAD	Overhead View	VT1.5 Overhead

NOTE. *The choices available depend on the mapping of the received signal.*

- Select **VT1.5 Overhead** to display the V5 overhead byte.

Displaying the J1 Path Trace Message

To view the Path Trace Message:

Press Menu Button	Select Menu Page	Highlight Parameter	Select Choice
RECEIVE	PATH OVERHEAD (see Figure 3–41)	<i>none</i>	<i>none</i>

Displaying the V5 Byte

To view the V5 byte:

Press Menu Button	Select Menu Page	Highlight Parameter	Select Choice
RECEIVE	PATH OVERHEAD (see Figure 3-41)	Overhead View	VT1.5 Overhead

Tek Measurements Stopped

RECEIVE

Receiving OC-1 with STS-1 # 1 under test

Overhead View **STS Path Overhead**

External Drop None

Pause Control Updates Active

CHOICES

STS Path Overhead

V5 Byte

Path Overhead	Path Trace Message
J1: 00100000	→ Tektronix CTS 710 SONET Test Set. Hello, how are you? %f
B3: 10111010	
C2: 00000010	
G1: 00000000	
F2: 00000000	
H4: 11111101	
Z3: 00000000	
Z4: 00000000	
Z5: 00000000	

RECEIVE SETTINGS | SIGNAL STATUS | TRANSPORT OVERHEAD | **PATH OVERHEAD**

Figure 3-41: J1 Path Trace Message Received by the CTS 710

Dropping DCC and User Channel Overhead Bytes

You drop the contents of the Data Communications Channel (DCC) and User Channel to an external protocol analyzer. The data from the DCC and User Channel is dropped through the Overhead Add/Drop Port located on the rear panel. See *Appendix G* for detailed information on the port pin assignments.

To drop data from the DCC:

1. Connect an external protocol analyzer to the CTS 710 using the Overhead Add/Drop Port on the rear panel of the CTS 710.

2. Configure the CTS 710 to drop the DCC data bytes:

Press Menu Button	Select Menu Page	Highlight Parameter	Select Choice
RECEIVE	TRANSPORT OVERHEAD	External Drop (see Figure 3-42)	None
			D1-D3
			D4-D12
			F1

- Select **None** if you do not want to drop the DCC bytes.
- Select **D1-D3** to drop the D1-D3 bytes of the DCC.
- Select **D4-D12** to drop the D4-D12 bytes of the DCC.
- Select **F1** to drop the F1 byte of the DCC.

Tek Measurements Stopped

RECEIVE STS-1 STS-1

Receiving STS-1 with STS-1 #1 under test
 Showing Overhead for STS-1 #1
 External Drop **DCC D1-D3**
 Pause Control Updates Active

Column 1	Column 2	Column 3
A1: 11110110	A2: 00101000	C1: 00000000
B1: 10001100	E1: 00000000	F1: 00000000
D1: 00000000	D2: 00000000	D3: 00000000
H1: 01100010	H2: 00001010	H3: 00000000
B2: 11100100	K1: 00000000	K2: 00000000
D4: 00000000	D5: 00000000	D6: 00000000
D7: 00000000	D8: 00000000	D9: 00000000
D10: 00000000	D11: 00000000	D12: 00000000
Z1: 00000000	Z2: 00000000	E2: 00000000

CHOICES

None

D1-D3

D4-D12

F1

F2

RECEIVE SETTINGS | SIGNAL STATUS | **TRANSPORT OVERHEAD** | PATH OVERHEAD

Figure 3-42: Dropping Data from the DCC

To drop data from the User Channel:

1. Connect an external protocol analyzer to the CTS 710 using the Overhead Add/Drop Port on the rear panel of the CTS 710.
2. Configure the CTS 710 to drop the User Channel data byte:

Press Menu Button	Select Menu Page	Highlight Parameter	Select Choice
RECEIVE	PATH OVERHEAD	External Drop (see Figure 3-43)	None
			F2

- Select **None** if you do not want to drop the User Channel data.
- Select **F2** to drop the User Channel byte.

Tek Measurements Stopped

RECEIVE

Receiving OC-1 with STS-1 # 1 under test

Overhead View STS Path Overhead

External Drop **F2 User Byte**

Pause Control Updates Active

Path Overhead

J1: 00110000 → Tektronix CTS 710 SONET
 B3: 10011111 Test Set. Hello, how are
 C2: 00000010 you?
 G1: 00000000
 F2: 00000000
 H4: 11111100
 Z3: 00000000
 Z4: 00000000
 Z5: 00000000

Path Trace Message

OC-1
OC-1

CHOICES

None

D1-D3

D4-D12

F1

F2

RECEIVE SETTINGS | SIGNAL STATUS | TRANSPORT OVERHEAD | **PATH OVERHEAD**

Figure 3-43: Dropping the User Channel Data Byte

Controlling the Display Update

To pause or continue overhead byte updating:

Press Menu Button	Select Menu Page	Highlight Parameter	Select Choice
RECEIVE	PATH OVERHEAD	Pause Control	Pause
			Continue

Setting Tributary Receive Parameters

This section describes how to manually set the receive rate, receive level, framing, and test pattern for tributary signals.

Pressing AUTOSCAN sets the receive parameters automatically based on the received signal.

Steps for Setting Parameters

The sequence of steps for setting receive parameters varies with signal to be received. Figure 3–44 shows the sequence of steps required to set the receive parameters for tributary signals (for example, DS3). Figure 3–45 shows the sequence of steps required to set the receive parameters for demultiplexing a DS1 signal from a DS3 signal.

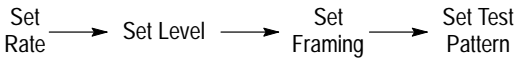

Figure 3–44: Sequence for Setting Tributary Signal Parameters

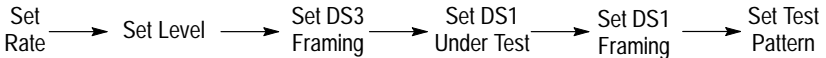

Figure 3–45: Sequence for Setting Signal Parameters to Demultiplex a DS1 from a DS3

Setting the Receive Rate

To set the receive rate:

Press Menu Button	Select Menu Page	Highlight Parameter	Select Choice
RECEIVE	RECEIVE SETTINGS (see Figure 3-46)	Receive Rate	<i>as appropriate</i>

- Select **DS1, DS3, or DS3->DS1 Demux** to receive a tributary rate signal.

Selecting DS3->DS1 Demux will demultiplex a DS1 signal from a received DS3 signal. All measurements are made at the DS1 level except for Loss of Signal.

Available DS_n Receive Rates

Tek Measurements Stopped

RECEIVE

Receive Rate **DS3**

Receive Level Normal (Cross Connect)

Framing DS3 Unframed

Test Pattern PRBS 2^23-1

Tx/Rx Settings Independent

↻ DS3
 ↻ DS3

CHOICES

OC-12

DS1

DS3

DS3->DS1 Demux

-more-
2 of 2

RECEIVE SETTINGS SIGNAL STATUS TRANSPORT OVERHEAD PATH OVERHEAD

Figure 3-46: Tributary Signal Receive Rates

Independent Receive and Transmit Settings

Generally, you can set the receive and transmit settings independently. For example, you can receive an electrical signal at the DS3 rate while simultaneously transmitting an optical signal at the OC-3 rate.

However, when working with tributary signals, the transmit and receive parameters are not completely independent. You cannot transmit a DS1 signal and receive a DS3 signal. When working with tributary signals, you must set the mapping for transmit and receive to the same value or to **No Mapping**. For example, you can transmit a VT1.5 signal and receive an OC-12 signal, but you must set the mapping of the received signal to either **No Mapping** or **VT1.5**; it cannot be set to DS3.

Coupling Receive and Transmit Settings

If your application requires that the receive settings and transmit settings be identical, you can save time by coupling them together. After they are coupled, any change you make to a parameter on the RECEIVE SETTINGS page will also be made to the corresponding setting in the TRANSMIT SETTINGS page of the RECEIVE menu. The inverse is also true.

To couple the receive and transmit settings together from the RECEIVE SETTINGS page:

Press Menu Button	Select Menu Page	Highlight Parameter	Select Choice
RECEIVE	RECEIVE SETTINGS	Tx/Rx Settings	Coupled

NOTE. When settings are coupled from the RECEIVE SETTINGS page, the transmit parameters are changed to match the receive parameters. Conversely, when settings are coupled from the TRANSMIT SETTINGS page, the receive parameters are changed to match the transmit parameters.

To change receive and transmit settings so that they are no longer coupled:

Press Menu Button	Select Menu Page	Highlight Parameter	Select Choice
RECEIVE	RECEIVE SETTINGS	Tx/Rx Settings	Independent

Notice that the signal status icons, in the upper-right corner of the display, changed to indicate that the settings are no longer coupled.

Setting the Receive Level

To specify the receive level for electrical signals:

Press Menu Button	Select Menu Page	Highlight Parameter	Select Choice
RECEIVE	RECEIVE SETTINGS	Receive Level	Normal
			Monitor
			Bridge

- Select **Normal** to set the line level to normal.
- Select **Monitor** to set the line level to the monitor level.
- Select **Bridge** to set the line level to the bridged level.

Setting the Framing

When receiving a tributary signal you can specify the framing of the signal.

To specify the framing of a received tributary signal:

Press Menu Button	Select Menu Page	Highlight Parameter	Select Choice
RECEIVE	RECEIVE SETTINGS	Framing	<i>as appropriate</i>

NOTE. The choices available for Framing depend on the selected Receive Rate.

- Select **DS1 Unframed** to receive an unframed DS1 signal.
- Select **DS1 SF (D4)** to receive a DS1 signal with SuperFrame framing.
- Select **DS1 ESF** to receive a DS1 signal with Extended SuperFrame framing.
- Select **DS3 Unframed** to receive an unframed DS3 signal.
- Select **DS3 C-bit** to receive a DS3 signal using C-bit framing.
- Select **DS3 M13** to receive a DS3 signal using M13 framing.

Specifying the Test Pattern

To specify the test pattern of the received signal:

Press Menu Button	Select Menu Page	Highlight Parameter	Select Choice
RECEIVE	RECEIVE SETTINGS	Test Pattern	<i>as appropriate</i>

NOTE. The choices available for Test Pattern depend on the selected Receive Rate.

- Select **1 in 8** to set the test pattern to 1000 0000.
- Select **User Word 8 bit**, **User Word 16 bit**, or **User Word 24 bit** to set a test pattern different from the preset choices. If you choose User Word, the test pattern description changes to User Defined Byte.
- Select **Unknown** when you do not know what test pattern is being transmitted or when the test pattern is not stable.

If you select User Word for the test pattern, set the value of the User Word as follows:

1. Select the line containing the byte to set the value of the User Defined Byte.
2. Define the contents of the User Defined Byte as follows:

Press Menu Button	Select Menu Page	Highlight Parameter	Select Choice
		<i>select displayed byte</i>	Set to 00000000
			Set to 11111111
			Default 10101010
			EDIT BYTE

- Select **Set to 00000000** to set the test pattern to all zeros.
 - Select **Set to 11111111** to set the test pattern to all ones.
 - Select **Default 10101010** to set the test pattern to alternating ones and zeros
3. Select **EDIT BYTE** to specify a value different from the preset choices.
 4. Select **DONE** when you are finished editing the byte.

Demultiplexing a DS1 from a DS3 Signal

To demultiplex a DS1 signal from a DS3 signal:

1. After setting the Receive Rate to DS3→DS1 Demux, specify the DS3 framing as follows:

Press Menu Button	Select Menu Page	Highlight Parameter	Select Choice
RECEIVE	RECEIVE SETTINGS	DS3 Framing	DS3 C-bit
			DS3 M13

2. Specify the DS1 User Test as follows:

Press Menu Button	Select Menu Page	Highlight Parameter	Select Choice
		DS1 Under Test	DS1 #1
			DS1 #28
			Next
			Previous

- Select **DS1 #1** to specify the first DS1 signal.
- Select **DS1 #28** to specify the last DS1 signal.
- Select **Next** to change the selection to the next higher DS1 signal.
- Select **Previous** to change the selection to the next lower DS1 signal.

3. Specify the DS1 Framing as follows:

Press Menu Button	Select Menu Page	Highlight Parameter	Select Choice
		Framing	DS1 Unframed
			DS1 SF (D4)
			DS1 ESF

- Select **DS1 Unframed** to demultiplex an unframed DS1 signal or a DS1 signal whose framing is unknown.
- Select **DS1 SF (D4)** to demultiplex a DS1 signal in D4 Superframe format.
- Select **DS1 ESF** to demultiplex a DS1 signal in Extended Superframe format.

4. Specify the received test pattern as follows:

Press Menu Button	Select Menu Page	Highlight Parameter	Select Choice
		Test Pattern	PRBS 2 ²³ -1
			PRBS 2 ²⁰ -1
			PRBS 2 ¹⁵ -1
			QRSS 2 ²⁰ -1
			All Ones
			All Zeros
			1 in 8
			3 in 24
			User Word 8 Bit
			User Word 16 Bit
			User Word 24 Bit
			Unknown

- Select **User Word 8 Bit**, **User Word 16 Bit**, or **User Word 24 Bit** to receive test patterns different from the preset choices. If you choose User Word, the test pattern description changes to show the selected bit pattern. Edit the bits of the word as needed.
- Select **Unknown** when you do not know what test pattern is being transmitted or when the test pattern is not stable.



Setting Alarms and Inserting Errors

This section describes how to simulate error conditions, set alarms, and simulate network failures. To test the response of a network, you might need to simulate parity errors, send alarm signals, and simulate network failures. This type of testing is simple and convenient using the CTS 710 SONET Test Set.

Simulating Error Conditions

The specific errors the CTS 710 simulates depend on the transmit rate and payload mapping.

Specifying the Error to Insert

Specify the type of error transmitted as follows:

Press Menu Button	Select Menu Page	Highlight Parameter	Select Choice
TRANSMIT	ERRORS & ALARMS	Error type set to	Section B1 BIP
			Line B2 BIP
			Path B3 BIP
			Path FEBE
			Frame Bit
			VT BIP (Add/Drop/Test Option Only)
			VT FEBE (Add/Drop/Test Option Only)
			Pattern Bit (Add/Drop/Test Option Only)
			CRC (ESF) (Add/Drop/Test Option Only)
			P-Bit (Add/Drop/Test Option Only)
			C-Bit (Add/Drop/Test Option Only)

NOTE. The errors available to insert depend on the Mapping and Payload settings. Not all errors are available all the time.

Inserting Errors

You can choose to insert errors manually (one at a time) or you can have errors inserted automatically at a rate you specify.

To insert a single error, press the **INSERT ERROR** button.

To have the CTS 710 insert errors automatically:

1. Turn on automatic error insertion as follows:

Press Menu Button	Select Menu Page	Highlight Parameter	Select Choice
TRANSMIT	ERRORS & ALARMS	Error rate set to	None
			1e-3
			1e-4
			1e-5
			1e-6
			1e-7
			1e-8
			USER DEFINED

- Select **None** to turn off automatic error insertion. However, you can still insert errors manually using the front-panel **INSERT ERROR** button.
- The maximum allowable error rate depends on the transmit rate, signal structure, and error type (see Tables 3–11 and 3–12).

Table 3–11: Maximum Error Rates for SONET Signals

Rate: Structure	Error Type				
	Section B1 BIP	Line B2 BIP	Path B3 BIP	Path FEBE	Pattern Bit
STS-1/OC-1: 1 X STS-1	1E-3	1E-3	1E-3	1E-3	1E-3
STS-3/OC-3: 3 X STS-1	1E-4	1E-4	1E-3	1E-3	1E-3
STS-3/OC-3: 1 X STS-3c	1E-4	1E-4	1E-4	1E-4	1E-3
OC-12: 12 X STS-1	1E-5	1E-4	1E-3	1E-3	1E-3
OC-12: 4 X STS-3c	1E-5	1E-4	1E-4	1E-4	1E-3

Table 3–12: Maximum Error Rates for Tributary Signals

Error Type	DS1		DS3	
	Maximum Rate	Minimum Rate	Maximum Rate	Minimum Rate
VT BIP	1E-3	1E-10	N/A	N/A
VT FEBE	1E-4	1E-10	N/A	N/A
Parity	N/A	N/A	1E-4	1E-9
CRC	1E-4	1E-8	N/A	N/A
Frame	1E-2	1E-5	1E-2	1E-7
Data	1E-2	1E-8	1E-2	1E-9

NOTE. The CTS 710 can measure all the error rates it can transmit except for DS3 Parity where the maximum measured error rate is $5e-5$.

2. Select **USER DEFINED** to specify an error rate different from the preset choices. The CTS 710 enters edit mode (Figure 3–47).
 - If the knob is assigned to Coarse, it changes the exponent.
 - If the knob is assigned to Fine, it changes the decimal number.
3. Select **DONE** to enter the error rate you have specified.

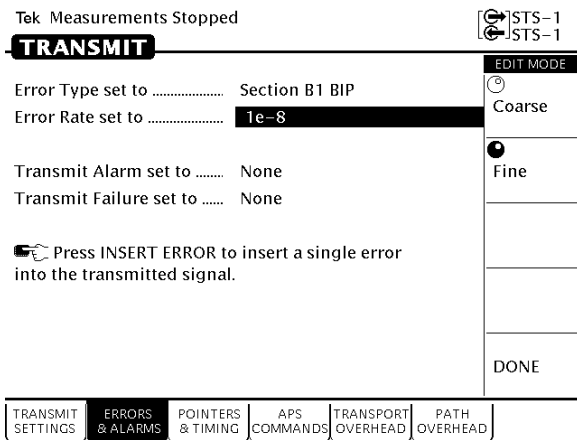

Figure 3–47: Setting An Error Rate

Setting Alarms

The CTS 710 can simulate alarm conditions to test the response of the network.

To transmit an alarm:

Press Menu Button	Select Menu Page	Highlight Parameter	Select Choice
TRANSMIT	ERRORS & ALARMS	Transmit alarm set to	None
			Line AIS
			Line FERF
			Path AIS
			Path FERF
			VT AIS (Add/Drop/Test Option Only)
			VT FERF (Add/Drop/Test Option Only)
			DSn Yellow (Add/Drop/Test Option Only)
			DSn AIS (Add/Drop/Test Option Only)
			DS3 Idle (Add/Drop/Test Option Only)

- Select **None** to stop transmitting an alarm.
- Select **Line AIS** to transmit a Line AIS alarm.
- Select **Line FERF** to transmit a Line FERF alarm.
- Select **Path AIS** to transmit a Path AIS alarm.
- Select **Path FERF** to transmit a Path FERF alarm.
- Select **VT AIS** to transmit a VT AIS alarm.

- Select **VT FERF** to transmit a VT FERF alarm.
- Select **DSn Yellow** to transmit a DSn Yellow alarm.
- Select **DSn AIS** to transmit a DSn AIS alarm.
- Select **DS3 Idle** to transmit a DS3 Idle alarm.

NOTE. *The VT AIS and VT FERF choices will be displayed only if Mapping, on the TRANSMIT SETTINGS page, is set to VT 1.5 Async.*

All transmit alarm choices remain in effect until they are deliberately turned off.

Simulating Transmit Failures

The CTS 710 can simulate transmit failure conditions to test the response of the network.

To simulate a transmit failure:

Press Menu Button	Select Menu Page	Highlight Parameter	Select Choice
TRANSMIT	ERRORS & ALARMS	Failure set to	None
			LOS
			LOF
			STS LOP (Add/Drop/Test Option Only)
			VT LOP (Add/Drop/Test Option Only)
			VT LOM (Add/Drop/Test Option Only)

NOTE. *VT LOP and VT LOM can be selected only if Mapping, on the TRANSMIT SETTINGS page, is set to VT 1.5 Async.*

- Select **None** to stop simulating failures.
- Select **LOS** to simulate a loss of signal failure.
- Select **LOF** to simulate a loss of frame failure.
- Select **STS LOP** to simulate a loss of pointer failure in the STS.
- Select **VT LOP** to simulate a loss of pointer failure in the virtual tributary.
- Select **VT LOM** to simulate a loss of multiframe failure in the virtual tributary.

All transmit failures remain in effect until they are deliberately turned off.

Setting Pointers and Changing Timing

This section describes how to generate pointer movements within the transmitted signal. When stress testing a network, you may want to move pointers or introduce a frequency offset. The CTS 710 SONET Test Set allows you to control this type of testing five ways. You can:

- Make discrete pointer movements under manual control
- Make repetitive pointer movements at a rate you determine
- Introduce a frequency offset in the internally generated SPE
- Introduce a frequency offset in the transmit rate
- Generate sequences of pointer movements

Setting Pointers

To set up the CTS 710 to make discrete or repetitive pointer movements:

1. Specify the pointer mode as follows:

Press Menu Button	Select Menu Page	Highlight Parameter	Select Choice
TRANSMIT	POINTERS & TIMING	Pointer / Timing Mode	Pointer Movement

The choices allow you to choose to move pointers using time parameters or with a frequency offset. Selecting Pointer Movements moves pointers utilizing time parameters.

2. Specify the pointer type as follows:

Press Menu Button	Select Menu Page	Highlight Parameter	Select Choice
TRANSMIT	POINTERS & TIMING	Pointer Type	STS Pointer
			VT Pointer

Manual Pointer Control

You can move pointers under manual control using the POINTER ACTION button on the front panel. To set up for this type of control, use the knob to highlight the **Pointer Control** line.

There are three types of manual pointer movements: Single, Burst, and Continuous (see Figure 3-48). The choices are described in detail below; some require additional setup.

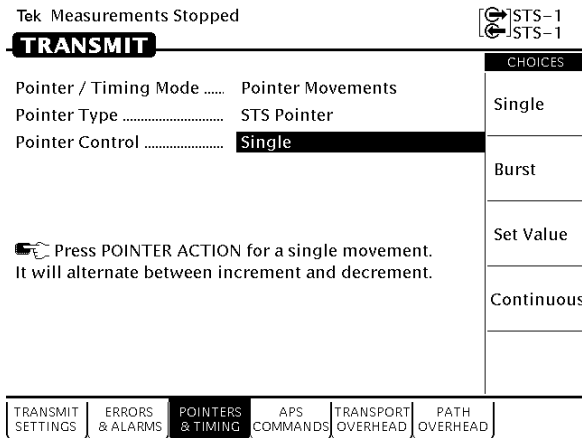

Figure 3-48: Manual Pointer Control Choices

Single Pointer Movements. With Single selected, each press of the front-panel POINTER ACTION button moves the pointer up or down

by one location. The first press increments the pointer, the second press decrements it, the third press increments it, and so forth.

Burst Pointer Movements. With Burst selected, pressing the front-panel **POINTER ACTION** button starts a burst of pointer movement. Each burst consists of a series of one-location pointer movements that are spaced four frames apart. Pressing **POINTER ACTION** repeatedly alternates between an incrementing burst and a decrementing burst (see Figure 3–49).

To set the number of pointer movements in the burst:

Press Menu Button	Select Menu Page	Highlight Parameter	Select Choice
		Pointer Control	Burst
		Burst Size	2
			3
			4
			5
			6
			7
			8

To start a burst of pointer movements, press **POINTER ACTION**.

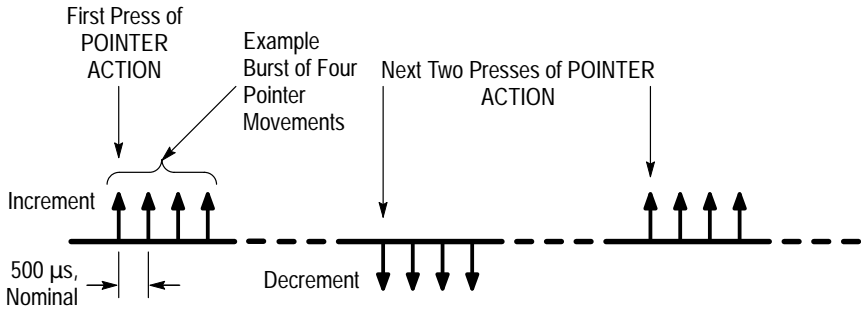

Figure 3-49: Alternating Burst Pointer Movement

Setting Pointer to a Specific Value. With Set to Value selected, you can move the pointer immediately to a new location, with or without a new data flag being set. Payload data can be lost when you use jump pointer movements of this type.

To set the new pointer value for an STS pointer:

Press Menu Button	Select Menu Page	Highlight Parameter	Select Choice
		Pointer Control	Set Value
		Pointer Value Set to	Min 0
			Max 782
			Default 522
			Illegal (Max + 1)
			USER DEFINED

- Select **Min 0** to set the pointer to location zero (points to the byte immediately following the H3 transport overhead byte). If you choose this setting, the pointer is moved immediately; you do not need to press POINTER ACTION.

- Select **Max 782** to set the pointer to location 782 (points to the byte immediately preceding the H1 transport overhead byte of the next frame). If you choose this setting, the pointer is moved immediately; you do not need to press **POINTER ACTION**.
- Select **Default 522** to set the pointer to location 522 (points to the first payload byte in the next frame). If you choose this setting, the pointer is moved immediately; you do not need to press **POINTER ACTION**.
- Select **Illegal (Max+1)** to move the pointer to illegal location 783 (the maximum allowed location + 1). Choosing the illegal pointer location may cause a loss-of-pointer failure. If you choose this setting, the pointer is moved immediately; you do not need to press **POINTER ACTION**.
- Select **USER DEFINED** to set the pointer to a value different from the preset choices.

Selecting **USER DEFINED** places the CTS 710 into Edit Mode.

- Select **DONE** when you are finished setting the pointer value.
As soon as you press **DONE**, the pointer is moved; you do not need to press **POINTER ACTION**.

To set the new pointer value for a VT pointer:

Press Menu Button	Select Menu Page	Highlight Parameter	Select Choice
		Pointer Control	Set Value
		Pointer Value Set to	Min 0
			Max 103
			Default 78
			Illegal (Max + 1)
			USER DEFINED

- Select **Min 0** to set the pointer to location zero. If you choose this setting, the pointer is moved immediately; you do not need to press POINTER ACTION.
 - Select **Max 103** to set the pointer to location 103. If you choose this setting, the pointer is moved immediately; you do not need to press POINTER ACTION.
 - Select **Default 78** to set the pointer to location 78. If you choose this setting, the pointer is moved immediately; you do not need to press POINTER ACTION.
 - Select **Illegal (Max+1)** to move the pointer to illegal location 104 (the maximum allowed location + 1). Choosing the illegal pointer location may cause a loss-of-pointer failure. If you choose this setting, the pointer is moved immediately; you do not need to press POINTER ACTION.
3. Specify whether a New Data Flag is set with the pointer movement as follows:

Press Menu Button	Select Menu Page	Highlight Parameter	Select Choice
		Set with New Data Flag	Yes
			No

4. Set the Pointer S-Bits as follows:

Press Menu Button	Select Menu Page	Highlight Parameter	Select Choice
		Pointer S-Bits	00
			01
			10
			11

Continuous Pointer Movement

To make repetitive pointer movements:

1. Specify the type of pointer control and movement rate as follows:

Press Menu Button	Select Menu Page	Highlight Parameter	Select Choice
		Pointer Control	Continuous
		Pointer Rate	Max 48 ms (Mapping = VT1.5 Async only)
			Max 2ms
			Min 10000ms
			Default 50ms
			USER DEFINED

- Select **Max 48ms** to move the pointer one location every 48 milliseconds.
 - Select **Max 2ms** to move the pointer one location every sixteen frames.
 - Select **Min 10000ms** to move the pointer location one location every 10 seconds.
 - Select **Default 50ms** to move the pointer one location every 50 ms.
 - Select **USER DEFINED** to set continuous pointer movement at a rate different from the preset choices.
2. Select **USER DEFINED** to set the pointer movement to a value different from the preset choices.

Selecting **USER DEFINED** places the CTS 710 into Edit Mode. Now you can set the rate to the exact value you want, with 1 ms resolution. The minimum rate is 1 ms. The maximum rate is 10000 ms.

3. Specify the pointer movement direction as follows:

Press Menu Button	Select Menu Page	Highlight Parameter	Select Choice
		Pointer Direction	Increment
			Decrement
			Alternate

- Selecting **Increment** causes the pointer to increment at the set rate.
- Selecting **Decrement** causes the pointer to decrement at the set rate.
- Selecting **Alternate** causes pointer movements at the set rate, but they alternate in incrementing and decrementing directions.

When using continuous pointer movement, a message line in the display tells you the equivalent payload frequency offset in parts per million if the pointer direction is set to either increment or decrement (see Figure 3–50).

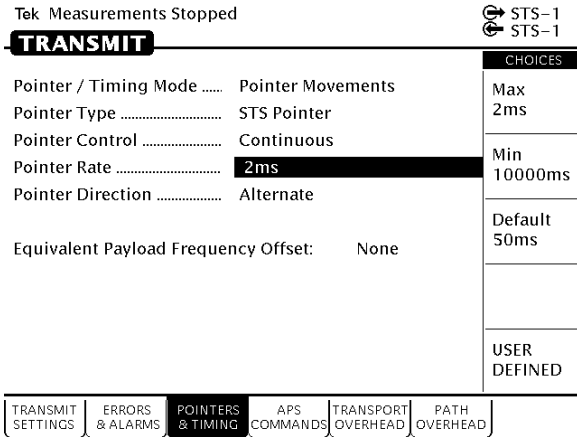

Figure 3–50: Incrementing Pointer Location Once Every Two Milliseconds

Changing Timing

As an alternative to setting pointer movements directly, you can introduce a frequency offset in the internally-generated SPE, the transmit line rate, or both together.

To generate pointer movements using frequency offset:

1. Specify the pointer/timing mode as follows:

Press Menu Button	Select Menu Page	Highlight Parameter	Select Choice
TRANSMIT	POINTERS & TIMING	Pointer / Timing Mode	Frequency Offset

2. Specify the Offset Mode as follows:

Press Menu Button	Select Menu Page	Highlight Parameter	Select Choice
		Offset Mode	Line
			Payload

- Select **Line** to change the transmit line rate. With this setting, the SPE location (pointer) does not move relative to the transmitted frame.
- Select **Payload** to change the offset of the payload.

3. Specify the frequency offset as follows:

Press Menu Button	Select Menu Page	Highlight Parameter	Select Choice
		Frequency Offset	Max +100ppm
			Stress +4.6ppm
			Stress -4.6ppm
			Default 0ppm
			USER DEFINED

- Select **Max +100ppm** to set the frequency offset to the maximum available amount.
- Select **Stress +4.6ppm** to set the frequency offset at the upper stratum three limit.
- Select **Stress -4.6ppm** to set the frequency offset at the lower stratum three limit.
- Select **Default 0ppm** to turn off frequency offset.
- Select **USER DEFINED** to set a frequency offset different from the preset choices.

Selecting **USER DEFINED** places the CTS 710 in Edit Mode. The knob is assigned to change the value of the frequency offset.

- Coarse changes the frequency offset by 10.0 ppm.
- Fine changes the frequency offset by 0.1 ppm.

The frequency offset can be changed by ± 100.0 ppm.

- Select **DONE** to enter the frequency offset when you are finished setting it.

When using a frequency offset, a message line in the display tells you the equivalent pointer movement rate. Figure 3–51 shows an example frequency offset and the resulting message.

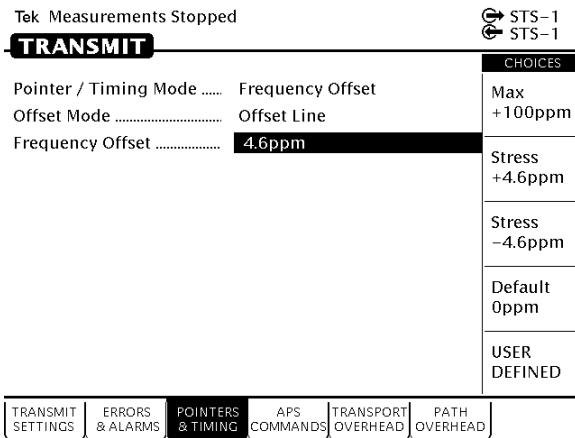

Figure 3–51: Offsetting the Transmit Rate by +4.6 ppm

Generating Pointer Sequences

In addition to the simpler pointer movements previously described, the CTS 710 can generate pointer sequences (sequences of pointer movements). Pointer sequences are made up of three periods: the Initialization Period, the Cool Down Period, and the Sequence Period (see Figure 3–52).

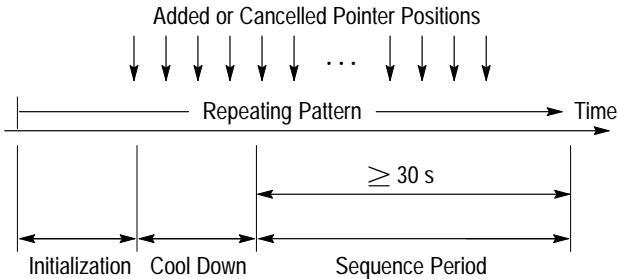

Figure 3-52: The Three Periods of a Pointer Sequence

- Initialization Period – a thirty second period where the CTS 710 produces a 30 second burst of 1 pointer movement per second in the same direction as the specified pointer sequence. The Initialization Period can be turned on or off.
- Cool Down Period – a period at least 60 seconds long, following the Initialization Period, where the specified pointer sequence is running.
- Sequence Period – the period following the Cool Down period where the specified pointer sequence runs continuously.

The CTS 710 generates the pointer sequences described in the ANSI T1.105.03-1994 standard. The CTS 710 also supports the sequences described in the ITU-T G.783 standard. An example of a pointer sequence is shown in Figure 3-53. The details of these sequences are shown in Table 3-13. Note that not all pointer sequences are available all the time. Some sequences are available only with one pointer type or with a specific mapping, as shown in Table 3-14.

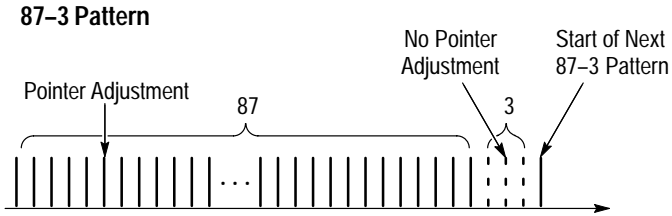

Figure 3-53: An Example of a Pointer Sequence

Table 3-13: Pointer Sequences Generated

Pointer Sequence	Description
Single	Time between pointer adjustments is 30 s.
Burst	Time between bursts of 3 pointers for STS pointers is 0.5 ms and for VT pointers is 2 ms. Time between pointer bursts is 30 s.
Phase Transient	Time between pointer movement burst of seven pointers is 0.25 s, 0.25 s, 0.5 s, 0.5 s, 0.5 s, 0.5 s. Time between pointer bursts is 30 s.
Periodic Continuous	Time between STS pointers has a range of 0.034 s to 10 s with a resolution of 1 ms.
Periodic Continuous with Cancel	Time between STS pointers has a range of 0.034 s to 10 s with a resolution of 1 ms. Time between cancelled pointers is equal to: (time between pointer movements \times N), where N is selected to be the smallest integer that makes the product \geq 30 s.

Table 3–13: Pointer Sequences Generated (Cont.)

Pointer Sequence	Description
Periodic Continuous with Add	<p>Time between added pointer movement and previous normal pointer movement for STS pointers is 0.5 ms and for VT1.5 pointers is 2 ms. Time between normal pointer movements is as follows:</p> <ul style="list-style-type: none"> • STS pointers have a range of 0.34 s to 10 s with a resolution of 1 ms. • VT1.5 pointer movements has a range of 1 s to 10 s with a resolution of 1 ms.
Periodic 87–3	<p>Sequence pattern is 87 pointer movements followed by 3 missing pointer movements.</p> <p>Time between STS pointer movements has a range of 0.34 s to 10 s with a resolution of 1 ms.</p>
Periodic 87–3 With Cancel	<p>Sequence pattern is 87 pointer movements followed by 3 missing pointer movements with a cancelled pointer movement at the 87th pointer.</p> <p>Time between STS pointer movements has a range of 0.34 s to 10 s with a resolution of 1 ms.</p> <p>Time between cancelled pointers is equal to: (time between pointers \times 90 \times N) where N is selected to be the smallest integer that makes this product \geq 30 s.</p>
Periodic 87–3 With Add	<p>Sequence pattern is 87 pointer movements followed by 3 missing pointer movements with an added pointer movement after the 43rd pointer.</p> <p>Time between STS pointer movements has a range of 0.34 s to 10 s with a resolution of 1 ms; time between added pointer movement and previous normal pointer movement for STS pointers is 0.5 ms.</p> <p>Time between added pointers is equal to: (time between pointers \times 90 \times N) where N is selected to be the smallest integer that makes this product \geq 30 s.</p>
Periodic 26–1	<p>Sequence pattern is 26 pointer movements followed by 1 missing pointer movement.</p> <p>Time between VT1.5 pointer movements has a range of 1 s to 10 s with a resolution of 1 ms.</p>

Table 3–13: Pointer Sequences Generated (Cont.)

Pointer Sequence	Description
Periodic 26–1 With Cancel	<p>Sequence pattern is 26 pointer movements followed by 1 missing pointer movement with a cancelled pointer movement at the 26th pointer, yielding a gap of 2.</p> <p>Time between VT1.5 pointer movements has a range of 1 s to 10 s with a resolution of 1 ms.</p> <p>Time between cancelled pointers is equal to: $(\text{time between pointers} \times 27 \times N)$ where N is selected to be the smallest integer that makes this product ≥ 30 s.</p>
Periodic 26–1 With Add	<p>Sequence pattern is 26 pointer movements followed by 1 missing pointer movement with an added pointer movement after the 13th pointer.</p> <p>Time between normal pointer movements has a range of 1 s to 10 s with a resolution of 1 ms; time between added pointer movement and previous normal pointer movement is 2 ms.</p> <p>Time between added pointers is equal to: $(\text{time between pointers} \times 27 \times N)$ where N is selected to be the smallest integer that makes this product ≥ 30 s.</p>
Single Alternating	Alternating single pointer movement. The time between pointer movements is 30 s.
Double Alternating	Alternating double pointer movement. The time between the double pointer movements is 2 ms, and the time between each pair of pointer movements is 30 s.

Table 3–14: Availability of Pointer Sequences

Pointer Sequence	Mapping	
	STS	VT1.5
Single	✓	✓
Burst	✓	✓
Phase Transient	✓	✓

Table 3-14: Availability of Pointer Sequences (Cont.)

Pointer Sequence	Mapping	
	STS	VT1.5
Periodic Continuous	✓	✓
Periodic Continuous with Cancel	✓	✓
Periodic Continuous with Add	✓	✓
Periodic 87-3	✓	
Periodic 87-3 With Cancel	✓	
Periodic 87-3 With Add	✓	
Periodic 26-1		✓
Periodic 26-1 With Cancel		✓
Periodic 26-1 With Add		✓
Single Alternating	✓	✓
Double Alternating	✓	✓

Starting Pointer Sequences

To set up the CTS 710 to make generate pointer sequences:

1. Specify the pointer mode as follows:

Press Menu Button	Select Menu Page	Highlight Parameter	Select Choice
TRANSMIT	POINTERS & TIMING	Pointer / Timing Mode	Pointer Sequences

The choices allow you to move pointers using time parameters, with a frequency offset, or in sequences. Selecting Pointer Sequences moves pointers in sequential patterns.

2. Specify the pointer type as follows:

Press Menu Button	Select Menu Page	Highlight Parameter	Select Choice
		Pointer Type	STS Pointer
			VT Pointer

3. Specify the Sequence Type as follows:

Press Menu Button	Select Menu Page	Highlight Parameter	Select Choice
		Sequence Type	<i>as appropriate</i>

NOTE. *The pointer sequences available depend on the selected Pointer Type.*

4. If Sequence Type is set to anything other than Single or Double Alternating, set the pointer direction as follows:

Press Menu Button	Select Menu Page	Highlight Parameter	Select Choice
		Pointer Direction	Increment
			Decrement

5. If Sequence Type is set to one of the continuous patterns, set the pointer rate as follows:

Press Menu Button	Select Menu Page	Highlight Parameter	Select Choice
		Pointer Rate	1000ms
			2000ms
			5000ms
			10000ms
			USER DEFINED

- Select **USER DEFINED** to set a pointer rate different from the preset choices.

6. Specify whether Initialization Time is included as part of the pointer sequence as follows:

Press Menu Button	Select Menu Page	Highlight Parameter	Select Choice
		Initialization Time	On
			Off

NOTE. *The Initialization Time is a set value (either 0 seconds or 30 seconds); it cannot be changed directly.*

7. Specify whether Cool Down Time is included as part of the pointer sequence as follows:

Press Menu Button	Select Menu Page	Highlight Parameter	Select Choice
		Cool Down Time	On
			Off

NOTE. *The Cool Down Time is a calculated value based on the sequence type; it cannot be changed directly.*

8. To initiate a pointer sequence, press **POINTER ACTION**.

Pointer sequences will continue to run until they are stopped.

9. To stop a pointer sequence, press **POINTER ACTION**.

After you press **POINTER ACTION**, the pointer sequence begins. The status area at the bottom of the display will change to indicate where the CTS 710 is within the pointer sequence; see Figure 3–54. Table 3–15 describes the meaning of the lines in the status display.

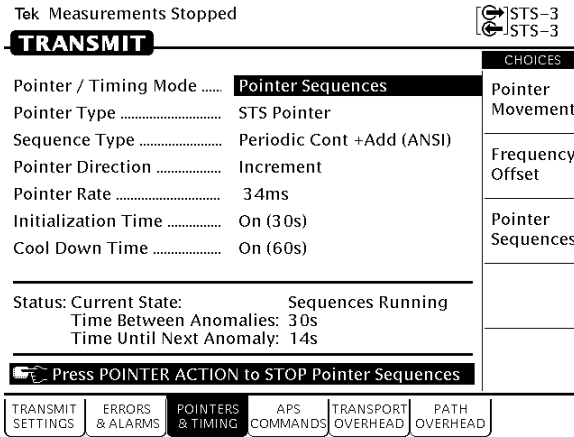

Figure 3-54: Status Display While Pointer Sequences are Running

Table 3-15: Status Lines for Pointer Sequences

Status Line	Description
Current State	Indicates the state of Pointer Sequences: Not Running, Initialization State, Cool Down, or Sequences Running
Time Between Anomalies ¹	Indicates the time between pointer anomalies
Time Until Next Anomaly ¹	Indicates the time remaining until the next anomaly occurs
Time Between Ptr Adj ¹	Indicates the time between pointer adjustments
Time Until Next Ptr Adj ¹	Indicates the time remaining until the next pointer adjustment occurs

¹ This information is displayed depending on sequence type. Not all information is displayed. When this information is displayed, Time Between Anomalies is displayed with Time Until Next Anomaly, and Time Between Ptr Adj is displayed with Time Until Next Ptr Adj.

Testing Automatic Protection Switching

This section describes how to generate Automatic Protection Switching (APS) commands and view the network response.

APS commands are located in the K1 and K2 bytes of the transport overhead. The K1 byte indicates a request for switch action. The K2 byte provides additional information about network architecture and alarm conditions.

Setting the APS Mode

The APS mode specifies whether the network is a ring network or a span network. The APS mode determines how the K1 and K2 bytes are interpreted and displayed by the CTS 710.

To specify the APS mode:

Press Menu Button	Select Menu Page	Highlight Parameter	Select Choice
TRANSMIT	APS COMMANDS (see Figure 3-55)	APS Mode	Span
			Ring

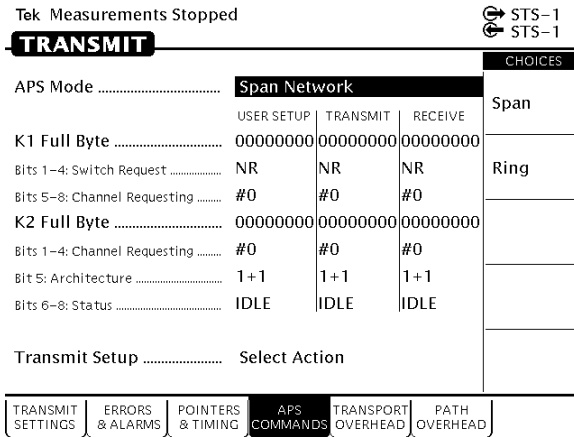

Figure 3–55: The APS COMMANDS Page

Setting the K1 Byte

There are two ways to edit the bits of the K1 byte. The first way is to set the value of each bit of the byte, one bit at a time. The second way is to assign values to the bits using preset choices, which use mnemonics to identify bit patterns.

To set the bit pattern of the K1 byte one bit at a time:

Press Menu Button	Select Menu Page	Highlight Parameter	Select Choice
TRANSMIT	APS COMMANDS	K1 FULL BYTE	Set to 00000000
			Set to 11111111
			Default 10101010
			EDIT BYTE

- Select **EDIT BYTE** to set the byte to a pattern different than the preset choices.

To set the bit pattern for the first four bits of the K1 byte:

Press Menu Button	Select Menu Page	Highlight Parameter	Select Choice
TRANSMIT	APS COMMANDS	Bits 1–4: Switch Request (under K1 FULL BYTE)	<i>as appropriate</i>

The selections available for the first four bits of the K1 byte depend on whether the mode is set to Ring or Span. See Tables 3–16 and 3–17 for descriptions of the preset choices.

Table 3–16: Choices for Bits 1–4 of the K1 Byte When Mode is Set to Ring

Main Screen Mnemonic	Choice Text	Bit Pattern
NR	NR No Request	0000
RR–R	RR–R Reverse Request Ring	0001
RR–S	RR–S Reverse Request Span	0010
EXER–R	EXER–R Exerciser Ring	0011
EXER–S	EXER–S Exerciser Span	0100
WTR	WTR Wait To Restore	0101
MS–R	MS–S Manual Switch Ring	0110
MS–S	MS–S Manual Switch Span	0111
SD–R	SD–R Signal Degrade Ring	1000
SD–S	SD–S Signal Degrade Span	1001
SD–P	SD–P Signal Degrade Protection	1010
SF–R	SF–R Signal Fail Ring	1011

Table 3–16: Choices for Bits 1–4 of the K1 Byte When Mode is Set to Ring (Cont.)

Main Screen Mnemonic	Choice Text	Bit Pattern
SF–S	SF–S Signal Fail Span	1100
FS–R	FS–R Forced Switch Ring	1101
FS–S	FS–S Forced Switch Span	1110
LP–S	LP–S Lockout of Protection Span	1111

Table 3–17: Choices for Bits 1–4 of the K1 Byte When Mode is Set to Span

Main Screen Mnemonic	Choice Text	Bit Pattern
NR	NR No Request	0000
DNR	DNR Do Not Revert	0001
RR	RR Reverse Request	0010
Not Used	Not Used	0011
EXER	EXER Exerciser	0100
Not Used	Not Used	0101
WTR	WTR Wait to Restore	0110
Not Used	Not Used	0111
MS	MS Manual Switch	1000
Not Used	Not Used	1001
SD–LP	SD Signal Degrade Low	1010
SD–HP	SD Signal Degrade High	1011
SF–LP	SF Signal Fail Low	1100

Table 3–17: Choices for Bits 1–4 of the K1 Byte When Mode is Set to Span (Cont.)

Main Screen Mnemonic	Choice Text	Bit Pattern
SF-HP	SF Signal Fail High	1101
FS	FS Forced Switch	1110
LP	LP Lockout of Protection	1111

The label for Bits 5–8, of the K1 byte, is Destination Node ID when the mode is set to Span. The label for Bits 5–8 is Channel Requesting when the mode is set to Ring.

To set the bit pattern for the last four bits of the K1 byte:

Press Menu Button	Select Menu Page	Highlight Parameter	Select Choice
TRANSMIT	APS COMMANDS	Bits 5–8: (under K1 FULL BYTE)	<i>as appropriate</i>

See Table 3–18 for descriptions of the preset choices.

Table 3–18: Choices for Bits 5–8 of the K1 Byte

Main Screen Mnemonic	Choice Text	Bit Pattern
#0	#0 (0000)	0000
#1	#1 (0001)	0001
#2	#2 (0010)	0010
#3	#3 (0011)	0011
#4	#4 (0100)	0100
#5	#5 (0101)	0101
#6	#6 (0110)	0110
#7	#7 (0111)	0111
#8	#8 (1000)	1000
#9	#9 (1001)	1001
#10	#10 (1010)	1010
#11	#11 (1011)	1011
#12	#12 (1100)	1100
#13	#13 (1101)	1101
#14	#14 (1110)	1110
#15	#15 (1111)	1111

Setting the K2 Byte

There are two ways to edit the bits of the K2 byte. The first way is to set the value of each bit of the byte, one bit at a time. The second way is to assign values to the bits using preset choices, which use mnemonics to identify bit patterns.

To set the bit pattern of the K2 byte one bit at a time:

Press Menu Button	Select Menu Page	Highlight Parameter	Select Choice
TRANSMIT	APS COMMANDS	K2 FULL BYTE	Set to 00000000
			Set to 11111111
			Default 10101010
			EDIT BYTE

- Select **EDIT BYTE** to set the byte to a pattern different than the preset choices.

The label for Bits 1–4, of the K2 byte, is Channel Requesting when the mode is set to Span. The label for Bits 5–8 is Source Node ID when the mode is set to Ring.

To set the bit pattern for the first four bits of the K2 byte:

Press Menu Button	Select Menu Page	Highlight Parameter	Select Choice
TRANSMIT	APS COMMANDS	Bits 1–4: (under K2 FULL BYTE)	<i>as appropriate</i>

See Table 3–19 for descriptions of the preset choices.

Table 3–19: Choices for Bits 1–4 of the K2 Byte

Main Screen Mnemonic	Choice Text	Bit Pattern
#0	#0 (0000)	0000
#1	#1 (0001)	0001
#2	#2 (0010)	0010
#3	#3 (0011)	0011
#4	#4 (0100)	0100
#5	#5 (0101)	0101
#6	#6 (0110)	0110
#7	#7 (0111)	0111
#8	#8 (1000)	1000
#9	#9 (1001)	1001
#10	#10 (1010)	1010
#11	#11 (1011)	1011
#12	#12 (1100)	1100
#13	#13 (1101)	1101
#14	#14 (1110)	1110
#15	#15 (1111)	1111

The label for Bit 5, of the K2 byte, is Architecture when the mode is set to Span. The label for Bit 5 is Path when the mode is set to Ring.

To set the value of the fifth bit of the K2 byte:

Press Menu Button	Select Menu Page	Highlight Parameter	Select Choice
TRANSMIT	APS COMMANDS	Bit 5: (under K2 FULL BYTE)	<i>as appropriate</i>

See Tables 3–20 and 3–21 for descriptions of the preset choices for Bit 5.

Table 3–20: Choices for Bit 5 of the K2 Byte When Mode is Set to Span

Main Screen Mnemonic	Choice Text	Bit Value
1+1	1+1	0
1:N	1:N	1

Table 3–21: Choices for Bit 5 of the K2 Byte When Mode is Set to Ring

Main Screen Mnemonic	Choice Text	Bit Value
SHORT	SHORT	0
LONG	LONG	1

The label for Bits 6–8, of the K2 byte, is Status whether the mode is set to Ring or Span.

To set the bit pattern for the last three bits of the K2 byte:

Press Menu Button	Select Menu Page	Highlight Parameter	Select Choice
TRANSMIT	APS COMMANDS	Bits 6–8: (under K2 FULL BYTE)	<i>as appropriate</i>

See Table 3–22 for descriptions of the preset choices.

Table 3–22: Choices for Bits 6–8 of the K2 Byte

Main Screen Mnemonic	Choice Text	Bit Pattern
IDLE	IDLE	000
BR	BR Bridged	001
BR&SW	BR & SW Bridged & Switched	010
Not Used	Not Used	011
Not Used	Not Used	100
Not Used	Not Used	101
FERF	FERF	110
AIS	AIS	111

Transmitting the K1 and K2 Bytes

Changing the values of the K1 and K2 bytes, shown in the USER SETUP column, does not automatically change the values of the transmitted K1 and K2 bytes. The TRANSMIT column shows the K1 and K2 bytes that are being transmitted.

NOTE. You can edit the transmitted K1 and K2 bytes directly from the TRANSPORT OVERHEAD page.

To transmit new K1 and K2 bytes:

Press Menu Button	Select Menu Page	Highlight Parameter	Select Choice
TRANSMIT	APS COMMANDS	Transmit Setup	Transmit User Setup
			Transmit Default
			Transmit Illegal

NOTE. You cannot transmit new values for the K1 or K2 bytes when the CTS 710 is transmitting a Line AIS or Line FERF.

- Select **Transmit User Setup** to change the value of the K1 and K2 bytes to that shown under USER SETUP.
- Select **Transmit Default** to change all the bits in the K1 and K2 bytes to zeros.
- Select **Transmit Illegal** to change all the bits in the K1 and K2 bytes to ones.

When you select an action from the Transmit Setup line, the TRANSMIT column is updated.

Viewing the Network Response to APS Commands

To view the network response to APS commands:

Press Menu Button	Select Menu Page	Highlight Parameter	Select Choice
TRANSMIT	APS COMMANDS	none	none

The network response to APS commands appears under the column labeled RECEIVE on the APS COMMANDS page (see Figure 3-56).

The RECEIVE Column

Tek Measurements Stopped

TRANSMIT STS-1 STS-1

		ACTIONS	
APS Mode	Span Network	TRANSMIT	RECEIVE
K1 Full Byte	11010011	1101001	11010011
Bits 1-4: Switch Request	SF-HP	SF-HP	SF-HP
Bits 5-8: Channel Requesting	#3	#3	#3
K2 Full Byte	00111111	0011111	100111111
Bits 1-4: Channel Requesting	#3	#3	#3
Bit 5: Architecture	1:N	1:N	1:N
Bits 6-8: Status	AIS	AIS	AIS
Transmit Setup	Select Action		

TRANSMIT SETTINGS ERRORS & ALARMS POINTERS & TIMING **APS COMMANDS** TRANSPORT OVERHEAD PATH OVERHEAD

Figure 3-56: The RECEIVE Column on the APS COMMANDS Page

Viewing Results

This section describes how to view, save, recall, and print test results.

You can look at test results while a test is running or after it has completed. The CTS 710 SONET Test Set can display test results as a summary or in a more detailed tabular form. The CTS 710 also displays measurement history in a graphical format.

Viewing a Summary of Results

To display a summary of test results:

Press Menu Button	Select Menu Page	Highlight Parameter	Select Choice
RESULTS	TEST SUMMARY	<i>none</i>	<i>none</i>

Figure 3–57 shows the TEST SUMMARY page. The top half of the display shows the source of the displayed results, the line rate of the displayed results, the mapping of the displayed results, when the displayed test results started and the duration of the test (elapsed time). The bottom half of the display is where the TroubleScan feature displays information. TroubleScan provides a quick overview of test results by displaying the four most significant alarm, failure, or error conditions that have occurred during the test. The specific conditions that TroubleScan displays depends on the problems that occur in the signal during the test.

Viewing Results

Tek Measurements Stopped ↻ STS-1
↻ STS-1

RESULTS

Results Source: ↻ Current Results
Results Rate: STS-1
Results Mapping: Equipped
Test Started: 20:32:00 16-Jul-95
Elapsed Time: 0d 0h 0m

TROUBLE SCAN
No Alarms No Errors

TEST SUMMARY	MAIN RESULTS	ERROR ANALYSIS	HISTORY GRAPHS	SAVE RESULTS	RECALL RESULTS
--------------	--------------	----------------	----------------	--------------	----------------

Figure 3-57: The Test Summary Page

Viewing Detailed Results

You can view results either as a summary or as a history. The summary format displays test results in a table. The history format displays test results in a graphical format.

The summary format is displayed on two pages in the RESULTS menu, the MAIN RESULTS page, and the ERROR ANALYSIS page. The MAIN RESULTS page provides an overview of test results, divided into four categories: Errors, Failures, Alarms, and Pointers. The ERROR ANALYSIS page displays an analysis of errors according to T1M1. Errors on the ERROR ANALYSIS page are displayed by Section, Line, Path, VT 1.5, DSn Path, or Pattern.

Displaying an Overview of Test Results

To display an overview of test results:

Press Menu Button	Select Menu Page	Highlight Parameter	Select Choice
RESULTS	MAIN RESULTS	<i>none</i>	Errors
			Failures
			Alarms
			Pointers

Table 3–23 lists all of the test results that are displayed on the MAIN RESULTS page.

Table 3–23: Results Displayed on MAIN RESULTS Page

Category	Error Displayed
Errors	Parity
	Section B1 BIP
	Line B2 BIP
	Path B3 BIP
	VT BIP
	Pattern Bit
	DS1 CRC
	P-Bit Parity
	Line FEBE
	Path FEBE
	VT FEBE
Frame Bit	
Failures	Loss of Signal Seconds

Table 3–23: Results Displayed on MAIN RESULTS Page (Cont.)

Category	Error Displayed
	Loss of Frame Seconds
	Out of Frame Seconds (SEFS)
	Loss of STS Pointer Seconds
	Loss of Power Seconds
	Loss of VT Pointer Seconds
	VT LOM Seconds
	Loss of Pattern Sync Seconds
	DSn Loss of Frame Seconds
Alarms	Line AIS Seconds
	Line FERF Seconds
	Path AIS Seconds
	Path FERF Seconds
	VT AIS Seconds
	VT FERF Seconds
	DSn AIS Seconds
	DSn Yellow Seconds
Pointers	Loss of Pointer Seconds
	New Data Flag Seconds
	Illegal Pointer Seconds
	Positive Justifications
	Negative Justifications
	Illegal Pointer Count
	Pointer Value

The Errors category of the MAIN RESULTS page displays results in three ways. The first way displays the count for each type of error. The second way displays the error ratio for each error. The third way displays the number of errored seconds that occurred for each type of error during the test.

The Failures category of the MAIN RESULTS page displays the number of seconds that the failure occurred.

The Alarms category of the MAIN RESULTS page displays the number of seconds that the alarm occurred.

The Pointers category of the MAIN RESULTS page displays the number of seconds certain conditions existed and the number of times certain actions occurred.

Displaying an Analysis of Test Results

To display an analysis of test results:

Press Menu Button	Select Menu Page	Highlight Parameter	Select Choice
RESULTS	ERROR ANALYSIS	<i>none</i>	Section
			Line
			Path Analysis
			VT Analysis
			Pattern Analysis
			DSn Path Analysis

Tables 3–24 through 3–30 detail the error analysis that appears on the ERROR ANALYSIS page. With the exception of the error count, the analysis of the error conditions that appear on the ERROR ANALYSIS page is made up of two numbers. The first number is the number of seconds the condition existed. The second number is the percentage of the test duration that the condition existed.

Table 3-24: T1M1 Section Analysis Results Displayed on the ERROR ANALYSIS Page

Category	Type	Analysis Result
Section	Section Analysis (B1 BIP)	Error Counts
		Errored Seconds
		Errored Seconds – Type A
		Errored Seconds – Type B
		Severely Errored Seconds
		Severely Errored Framing Seconds
		Error Free Seconds

Table 3-25: T1M1 Line Analysis Results Displayed on the ERROR ANALYSIS Page

Category	Type	Analysis Result
Line	Line Analysis (B2 BIP)	Error Counts
		Errored Seconds
		Errored Seconds – Type A
		Errored Seconds – Type B
		Severely Errored Seconds
		Unavailable Seconds
		Error Free Seconds
	Line Analysis (FEBE)	Error Counts
		Errored Seconds
		Unavailable Seconds
		Error Free Seconds

Table 3-26: T1M1 Path Analysis Results Displayed on the ERROR ANALYSIS Page

Category	Type	Analysis Result
Path	Path Analysis (B3 BIP)	Error Counts
		Errored Seconds
		Errored Seconds – Type A
		Errored Seconds – Type B
		Severely Errored Seconds
		Unavailable Seconds
		Error Free Seconds
	Path Analysis (FEBE)	Error Counts
		Errored Seconds
		Unavailable Seconds
		Error Free Seconds

Table 3-27: T1M1 VT1.5 Analysis Results Displayed on the ERROR ANALYSIS Page

Category	Type	Analysis Result
VT 1.5 Analysis	VT Analysis (V5 BIP)	Error Counts
		Errored Seconds
		Errored Seconds – Type A
		Errored Seconds – Type B
		Severely Errored Seconds
		Unavailable Seconds
		Error Free Seconds

Table 3-27: T1M1 VT1.5 Analysis Results Displayed on the ERROR ANALYSIS Page (Cont.)

Category	Type	Analysis Result
	VT 1.5 Analysis (FEBE)	Error Counts
		Errored Seconds
		Unavailable Seconds
		Error Free Seconds

Table 3-28: T1M1 Payload Analysis Results Displayed on ERROR ANALYSIS Page

Category	Type	Analysis Result
Payload	Payload Analysis (Bit Error)	Error Counts
		Errored Seconds
		Errored Seconds – Type A
		Errored Seconds – Type B
		Severely Errored Seconds
		Unavailable Seconds
		Error Free Seconds

NOTE. *There is no analysis performed on unframed DS1 or DS3 signals.*

Table 3–29: DS1 Path Analysis Results Displayed on ERROR ANALYSIS Page

Category	Type	Analysis Result
DS1 Path	DS1 Analysis (Frame Bit)	Error Counts
		Errored Seconds
		Errored Seconds – Type A
		Errored Seconds – Type B
		Severely Errored Seconds
		Unavailable Seconds
		Error Free Seconds

Table 3–30: DS3 Path Analysis Results Displayed on ERROR ANALYSIS Page

Category	Type	Analysis Result
DS3 Path	DS3 Analysis (P-Bit Parity)	Error Counts
		Errored Seconds
		Errored Seconds – Type A
		Errored Seconds – Type B
		Severely Errored Seconds
		Unavailable Seconds
		Error Free Seconds

Viewing Measurement Histories

The CTS 710 records measurement histories whenever you run a test. Measurement histories are displayed as graphs. The graph displays how an individual measurement changed over time. The vertical axis

of a graph depends on what is displayed, but the horizontal axis always displays time.

To display a history graph:

Press Menu Button	Select Menu Page	Highlight Parameter	Select Choice
RESULTS	HISTORY GRAPHS	<i>none</i>	<i>none</i>

Types of Graphs

There are three types of history graphs: bar graphs, line graphs, and on/off graphs.

Bar Graphs. Bar graphs are used for most measurements (see Figure 3–58). There are two kinds of bar graphs: a count graph that displays code violations and pointer justifications and an errored seconds graph that displays errored seconds. Table 3–31 lists the different bar graphs that can be displayed.

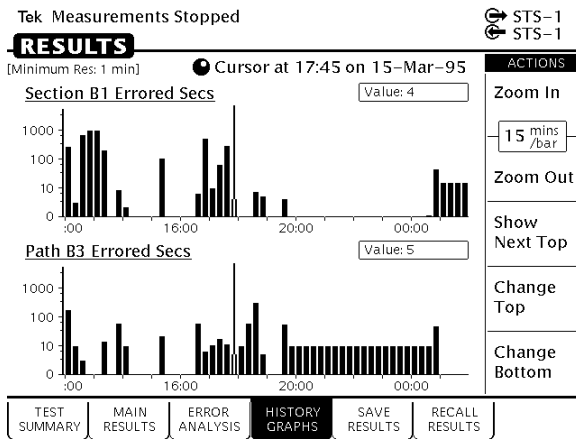

Figure 3–58: Bar Graphs Showing Code Violations and Errored Seconds

Table 3–31: Measurements Displayed as Bar Graphs

Measurement
Section B1 Error Counts
Section B1 Errored Secs
Line B2 Error Counts
Line B2 Errored Secs
Line FEBE Error Counts
Path B3 Error Counts
Path B3 Errored Secs
Path FEBE Error Counts
Pattern Error Counts
Pattern Errored Secs
STS Pointer Justifications
VT Pointer Justifications
VT BIP2 Errors
VT BIP2 Errored Secs
VT FEBE Error Count
VT FEBE Errored Secs
CRC/Parity Errored Seconds
Frame Errored Seconds

Line Graphs. A line graph is used to display pointer movement history (see Figure 3–59). The vertical axis of the line graph ranges from 0 to the maximum, which is different for SPEs and VTs. There is only one measurement displayed as a line graph, as shown in Table 3–32.

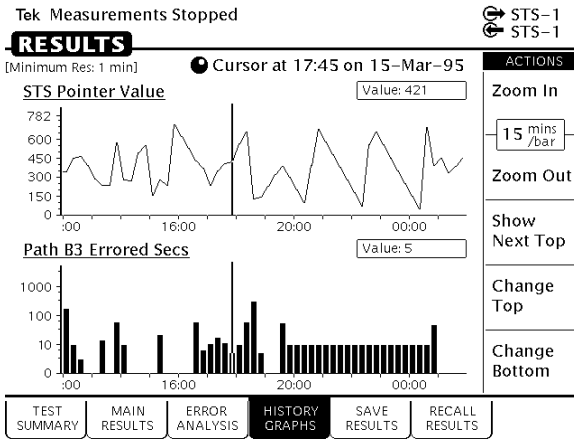

Figure 3-59: Line Graph Showing Pointer Value

Table 3-32: Measurements Displayed as a Line Graph

Displayed Value
STS Pointer Value
VT Pointer Value

On/Off Graphs. On/off graphs indicate whether alarms and failures were on or off (see Figure 3-60). There are only two types of on/off graphs, as shown in Table 3-33. One type displays alarms and the other type displays failures.

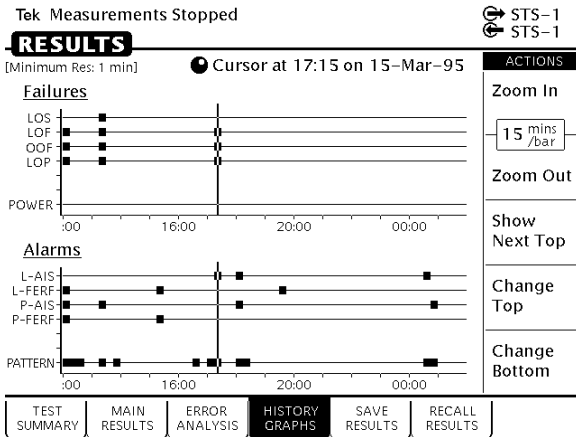

Figure 3-60: On/Off Graphs Showing Failures and Alarms

Table 3-33: Measurements Displayed as On/Off Graphs for SONET Rates

Graph Type	Displayed Value
Failures	LOS
	LOF
	OOF
	STTS LOP
	VT LOP
	VT LOM
	Power
SONET Alarms	L-AIS
	L-FERF
	P-AIS
	P-FERF

Table 3-33: Measurements Displayed as On/Off Graphs for SONET Rates (Cont.)

Graph Type	Displayed Value
	VT AIS
	VT FERF
	Pattern

Table 3-34: Measurements Displayed as On/Off Graphs for Tributary Rates

Graph Type	Displayed Value
DSn Alarms	Idle
	AIS
	Yellow

Elements of the History Graph Display

Figure 3-61 shows the elements of a typical history graph display. The HISTORY GRAPHS page always displays two graphs. The two graphs can be changed to display any measurement taken during a test.

Graph Name

Above each graph is a name that identifies the measurement the graph illustrates.

History Resolution

Above the graph name is a line that states the minimum resolution at which the graph can be displayed. The minimum resolution is set at the time the test is run.

Power Out Indicator

If the power to the CTS 710 fails while a test is running, the CTS 710 displays the words “POWEROUT” on the history graph. POWEROUT is displayed vertically on the graph and spans the period of time the CTS 710 was without power.

Cursor

The cursor is a line that is scrolled across the graph using the knob.

Cursor Position

Just below the menu name is a line that identifies the position of the cursor. Cursor position is identified by time and date.

Measurement Results at Cursor Position

To the right of the graph name is a box that displays the value of the measurement at the cursor location (the box is not displayed for history graphs of alarms or failures). If the displayed graph represents errored seconds, the measurement results box displays the number of errored seconds that occurred during the interval indicated. If the displayed graph represents an error count, the measurement results box displays the number of errors counted during the indicated interval and the resulting bit error rate (BER).

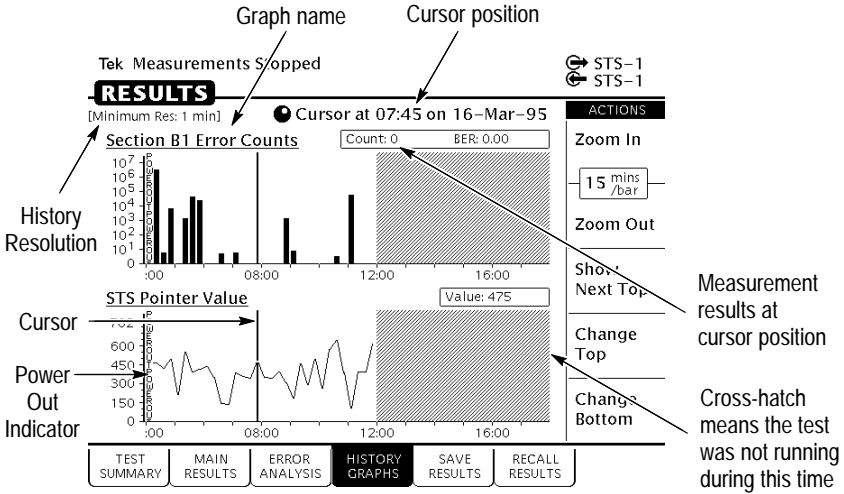

Figure 3-61: Elements of a History Graph

Zooming History Graphs

History graphs display measurement history in intervals. Each interval is represented by a bar on the history graph. The interval of time represented by a bar can be changed. Changing the interval a bar represents is called zooming. History graphs can be zoomed out or in. When a history graph is zoomed out, a bar represents a increasingly longer period of time. When a history graph is zoomed in, a bar represents a decreasingly shorter period of time. Table 3-35 lists the intervals a bar can represent, depending on the history resolution setting when the test was run.

Table 3-35: Time Represented by Bars on History Graph

History Resolution = Normal (1 min samples)	History Resolution = Low (15 min samples)
1 minute	15 minutes
5 minutes	60 minutes

Table 3–35: Time Represented by Bars on History Graph (Cont.)

History Resolution = Normal (1 min samples)	History Resolution = Low (15 min samples)
15 minutes	4 hours
60 minutes	12 hours

There are 56 intervals of a history graph displayed on the screen at a time. At a resolution of one minute per bar, a history graph displays test results for a period of 56 minutes. At a resolution of 15 minutes per bar, a history graph displays test results for a period of 840 minutes, or 14 hours.

The minimum test duration required to display results on a history graph is one minute. Tests shorter than one minute will not display any results on the HISTORY GRAPHS page. However, test results do appear on the MAIN RESULTS and ERROR ANALYSIS pages for tests shorter than one minute.

The longest period for which test results are displayed is 72 hours (3 days) at a History Resolution of 1 minute or 1080 hours (45 days) at a History Resolution of 15 minutes. If you run a test continuously, only results for the last 72 hours (1 minute resolution) or 1080 hours (15 minutes resolution) are maintained in memory.

To zoom in a history graph, select **Zoom In**.

To zoom out a history graph, select **Zoom Out**.

NOTE. When viewing long test durations (for example, three days) at a resolution of one minute, you might see a timestamp error. For example, you might see two one-minute intervals stamped with the same time. The timestamp error is simply revealing the clock accuracy. The correct number of intervals for the test duration are present.

Panning History Graphs

You can display different portions of a history graph by panning the graph. Panning a history graph shifts the displayed section of the graph to the left or right.

At the maximum resolution of one minute per bar, a history graph can display only about one hour of test results. To maintain maximum resolution, you can display the graph at maximum resolution (one minute per bar) and pan to other portions of the history graph as necessary.

To pan a history graph, turn the knob.

When the knob is turned, the cursor moves across the history graph. If the history graph contains more data than will fit on the display, the history graph shifts to display additional information. The direction the display shifts depends on which direction the knob is turning.

Changing the Displayed History Graph

To change the displayed history graph:

Press Menu Button	Select Menu Page	Highlight Parameter	Select Choice
RESULTS	HISTORY GRAPHS		Show Next Top
			Change Top
			Change Bottom
		<i>select graph with knob</i> (see Figure 3-62)	Select Graph

- Select **Show Next Top** to automatically display the next graph on the top half of the screen.
- Select **Change Top** to select a different graph for display on the top half of the screen.

- Select **Change Bottom** to select a different graph for display on the bottom half of the screen.
- Select **Cancel** if you decide not to change the displayed graph.

Displaying Mini-Graphs

When you select either Change Top or Change Bottom from the HISTORY GRAPHS page, the selected graph is replaced by three mini-graphs (see Figure 3–62). Each mini-graph is a reduced-size version of a normal graph. Turn the knob to display a different graph. The middle graph, which is highlighted, is the graph that will be displayed full-size when you choose Select Graph. When you turn the knob, the mini-graphs scroll either up or down depending on which direction you turn the knob. Whether the next mini-graph appears at the top or the bottom depends on the direction the knob turns.

Use the mini-graph capability to view several results at once. With mini-graphs displayed, the CTS 710 displays four graphs at the same time. This will enable you to see relationships between different results that might otherwise be difficult to spot.

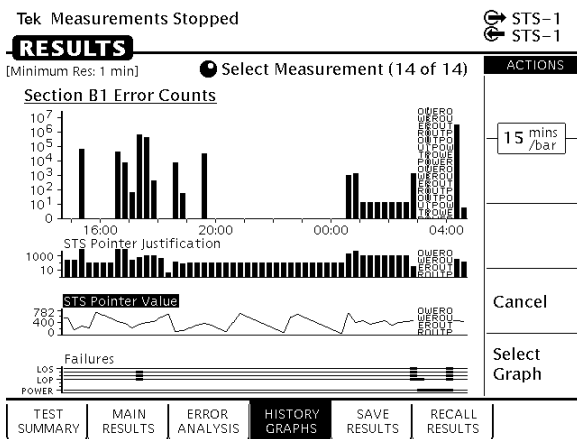

Figure 3–62: Changing the Displayed History Graph

Saving and Recalling Results

You can save test results to disk and recall the test results for later display and analysis. The CTS 710 automatically saves the results of the last two tests in memory. If you want to save test results permanently, you must save the test results to disk.

Saving Test Results to Disk

NOTE. *The CTS 710 saves only the last 3 days (at a History Resolution of Normal) or 45 days (at a History Resolution of Low) of test results. If a test runs longer than these limits, the results older than 3 days/45 days are discarded.*

To save test results to disk:

1. Name the test results file as follows:

Press Menu Button	Select Menu Page	Highlight Parameter	Select Choice
RESULTS	SAVE RESULTS (see Figure 3-63)	Name	RESLT_XX
			Clear
			EDIT NAME

- If you wish to name the results file as **RESLT<Number>**, you can save time by selecting **RESLT_XX**. Once you select **RESLT_XX**, select **EDIT NAME** and edit **XX** to the desired number (or letter). Select **DONE** when you are finished editing the setup name.
- Select **Clear** to remove an existing name. A message appears to remind you that you cannot save results to disk without a name.

- Select **EDIT NAME** to enter a name other than **RESULT_XX** for the pass/fail test. Select **DONE** when you are finished editing the test name.

Tek Measurements Stopped

RESULTS

The results of the last two tests are stored in memory. For a permanent record they must be saved to disk.

Name

Description

Save To Disk

Memory	Start Time/Date	Duration
Current	09:22:39 09-Dec-94	0d 0h 0m
Previous	09:20:26 09-Dec-94	0d 0h 0m

CHOICES

RESULT_XX

Clear

EDIT NAME

TEST SUMMARY MAIN RESULTS ERROR ANALYSIS HISTORY GRAPHS **SAVE RESULTS** RECALL RESULTS

Figure 3-63: The SAVE RESULTS Page

2. Enter a description of the test results file as follows:

Press Menu Button	Select Menu Page	Highlight Parameter	Select Choice
RESULTS	SAVE RESULTS	Description	EDIT TEXT
			None
			Clear

- Select **EDIT TEXT** to enter a description of the test results, up to 24 characters long. Select **DONE** when you are finished editing the description.
- Select **None** if you do not want to use a description.
- Select **Clear** to remove an existing description.

3. Save the test results to disk as follows:

Press Menu Button	Select Menu Page	Highlight Parameter	Select Choice
RESULTS	SAVE RESULTS	Save to Disk	Save Current
			Save Previous

At the bottom of the SAVE RESULTS page are two lines that identify the current and previous tests by start time/date and by duration.

- Select **Save Current** to save the current (most recent) test results.
- Select **Save Previous** to save the previous test results.

Recalling Test Results from Disk

To recall test results from disk:

1. Insert the disk containing the test results into the disk drive.
2. Select and recall the test results file as follows:

Press Menu Button	Select Menu Page	Highlight Parameter	Select Choice
RESULTS	RECALL RESULTS (see Figure 3-64)		Disk
		<i>select disk file name</i>	Recall Result

NOTE. The Disk action displays only files with the extensions *.HST* and *.MST*. It does not display any other files on the disk.

To verify that the file has been recalled, select the TEST SUMMARY page and look at the Results Source line at the top of

the page. The Results Source line will display the name of the file recalled.

Tek Measurements Stopped

STS-1
STS-1

RESULTS

Memory	Start Time	Duration
Current	09:22:39 09-Dec-94	0d 0h 0m
Previous	09:20:26 09-Dec-94	0d 0h 0m

Disk Description

Memory
Disk

ACTIONS

Recall Result

Delete File

TEST SUMMARY MAIN RESULTS ERROR ANALYSIS HISTORY GRAPHS SAVE RESULTS **RECALL RESULTS**

Figure 3-64: The RECALL RESULTS Page

Deleting Test Results from Disk

To delete test results from disk:

1. Insert the disk containing the test results into the disk drive.
2. Select the test results file to be deleted, as follows:

Press Menu Button	Select Menu Page	Highlight Parameter	Select Choice
RESULTS	RECALL RESULTS (see Figure 3-64)		Disk
		<i>select disk file name</i>	Delete File

Recalling Test Results from Memory

To recall test results from memory:

Press Menu Button	Select Menu Page	Highlight Parameter	Select Choice
RESULTS	RECALL RESULTS		Memory (see Figure 3-64)
		<i>select Current or Previous</i>	Recall Result

Printing Results

There are two ways to print out the results of the current test. One way is to tell the CTS 710 which results to print from the print dialog box. The second way is to display the results you wish to print out and then print the displayed screen (this is the only way to print out history graphs).

Results are printed according to the Printer Type, which is set on the PRINTER SETUP page (see page 3-203). Results can be printed to a printer or to a disk file. Results are printed to disk in three formats: Windows BMP format, Interleaf image format, and Encapsulated PostScript format.

Printing Main Results or Error Analysis

When the CTS 710 prints test results, it prints out the contents of the MAIN RESULTS page or the ERROR ANALYSIS page. The printed results are reformatted so that all results fit on a single page.

Before printing results, check that the printer setup is correct. The printer setup is displayed on the PRINTER SETUP page of the UTILITY menu.

To print the results of the current test:

Press Menu Button	Select Menu Page	Highlight Parameter	Select Choice
PRINT (see Figure 3–65)		Print Main Results	
		Print Error Analysis	Print
			Abort
			EXIT

- Highlight **Print Main Results** and then select **Print** to print the contents of the MAIN RESULTS page.
- Highlight **Print Error Analysis** and then select **Print** to print the contents of the ERROR ANALYSIS page.
- Select **Abort** to cancel a printout in process.
- Select **EXIT** if you decide not to print out any test results.

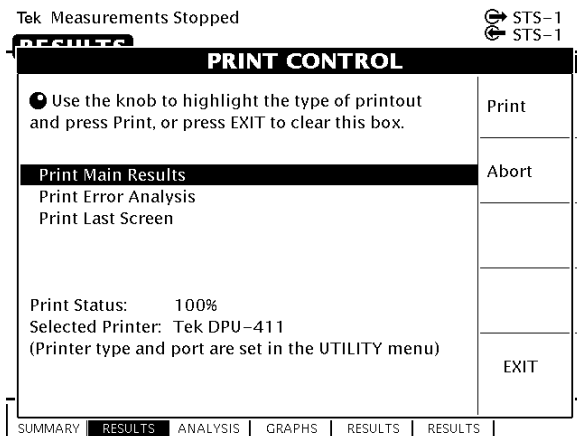

Figure 3–65: The PRINT CONTROL Dialog Box

To print the results of a test saved on disk, recall the results (see page 3–194) and then print as previously described.

To print the results of the previous test, recall the previous test (see page 3–196) and then print as previously described.

Printing History Graphs

To print a history graph from the CTS 710:

1. Display the history graph you want to print.

The history graph can be for the current test or the previous test or it can be recalled from disk.

2. Print the history graph as follows:

Press Menu Button	Select Menu Page	Highlight Parameter	Select Choice
PRINT (see Figure 3–65)		Print Last Screen	Print
			Abort
			EXIT

- Select **Print** to print the displayed history graph using the settings on the PRINTER SETUP page of the UTILITY menu.
- Select **EXIT** if you decide not to print any test results.
- Select **Abort** to cancel a printout in process.

Changing Instrument Settings

This section describes how to change the date and time settings, printer settings, and the GPIB and RS-232 parameters. This section describes how to display a screen that details the CTS 710 configuration. You will also find a description of how to run the instrument self-test in this section.

Viewing the Instrument Configuration

You can display a page that describes how the CTS 710 is configured as well as the installed options and the hardware and firmware revision level.

To display the instrument configuration:

Press Menu Button	Select Menu Page	Highlight Parameter	Select Choice
UTILITY	INSTR CONFIG	<i>none</i>	<i>none</i>

Table 3–36 describes the lines of the INSTR CONFIG page.

Table 3–36: Lines of the Instrument Configuration Page

Line	Description
Model	The model number of the instrument.
Serial Number	The serial number of the instrument.
Hardware Revision	The version of hardware.
Firmware Revision	The version of firmware.
Options	Separates information that applies to every instrument from information about optional configurations.

Table 3-36: Lines of the Instrument Configuration Page (Cont.)

Line	Description
Interface Module	Displays which interface module is installed (supported transmit and receive rates) and wavelength of module, if optical.
DS1/DS3 Option	Indicates whether the DS1/DS3 Add/Drop/Test option is installed.

Setting the Display Brightness

You can set the display brightness to three levels: Low, Medium, and High.

To set the display brightness:

Press Menu Button	Select Menu Page	Highlight Parameter	Select Choice
UTILITY	MISC SETTINGS (see Figure 3-66)	Display Brightness	Low
			Medium
			High

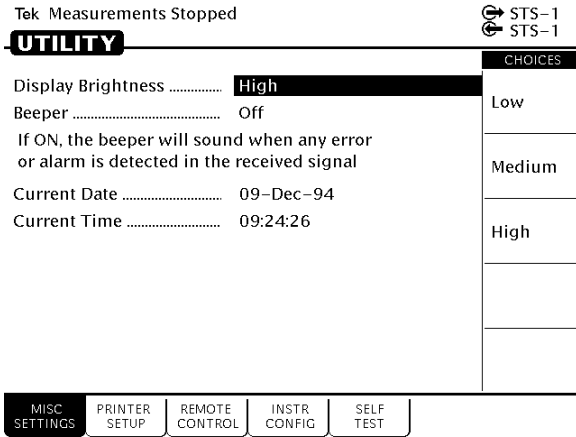

Figure 3-66: The MISC SETTINGS Page

Turning the Beeper On and Off

The CTS 710 has a beeper. The beeper is used alert you when a pass/fail test has completed, or when certain conditions occur. You can turn off the beeper if you wish.

To turn the beeper on or off:

Press Menu Button	Select Menu Page	Highlight Parameter	Select Choice
UTILITY	MISC SETTINGS (see Figure 3-66)	Beeper	On
			Off

Setting the Date

The date is used when writing files to disk, it is used to track measurement history, and it is used when displaying history graphs.

To set the date:

1. Display the current date setting as follows:

Press Menu Button	Select Menu Page	Highlight Parameter	Select Choice
UTILITY	MISC SETTINGS	Current Date	SET DATE

After you select SET DATE, the CTS 710 enters Edit Mode.

2. Assign the knob by selecting **Year**, **Month**, or **Day** as necessary.
3. Turn the knob to change the setting.
4. Select **CANCEL** to abort any changes and exit Edit Mode.
5. Select **DONE** to enter your changes and exit Edit Mode.

Setting the Time

The time is used when writing files to disk, it is used to track measurement history, and it is used when displaying history graphs.

To set the time:

1. Display the current time as follows:

Press Menu Button	Select Menu Page	Highlight Parameter	Select Choice
UTILITY	MISC SETTINGS (see Figure 3-66)	Current Time	SET TIME

After you select SET TIME, the CTS 710 enters Edit Mode.

NOTE. While you set the time in Edit Mode, the clock stops running.

2. Assign the knob by selecting **Hour**, **Minute**, or **Second** as necessary.
3. Turn the knob to change the setting.
4. Select **CANCEL** to abort any changes and exit Edit Mode.
5. Select **DONE** to enter your changes and exit Edit Mode.

Changing the Printer Setup

The CTS 710 prints to Tek DPU-411 printers, Epson-compatible printers, and Hewlett-Packard Thinkjet printers. It can also print to a file on disk. The print parameters are located on the **PRINTER SETUP** page of the **UTILITY** menu (see Figure 3-67). Printers are supported only by an RS-232 connection.

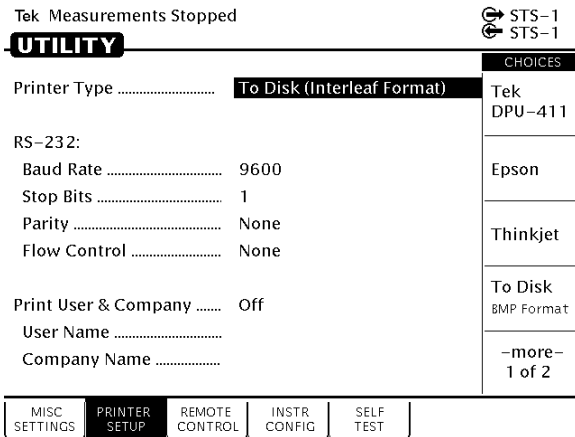

Figure 3-67: The PRINTER SETUP Page

Setting up the CTS 710 for a printer consists of two steps, specifying the printer or file type and setting RS-232 parameters. Additionally,

you can specify two lines of text to be included on any printout. The two lines of text identify the user name and the company name.

Specifying the Printer or File Type

To set the printer or file type:

Press Menu Button	Select Menu Page	Highlight Parameter	Select Choice
UTILITY	PRINTER SETUP	Printer Type	Tek DPU-411
			Epson
			Thinkjet
			To Disk BMP Format
			To Disk Ileaf Format
			To Disk EPS Format

- Select **To Disk BMP Format** to print a file to disk in Windows bitmap format.
- Select **To Disk Ileaf Format** to print a file to disk in Interleaf image format.
- Select **To Disk EPS Format** to print a file to disk in Encapsulated PostScript format.

Setting RS-232 Parameters

To determine the correct RS-232 settings for your printer, refer to the manual that came with your printer.

To set the RS-232 parameters for the printer:

Press Menu Button	Select Menu Page	Highlight Parameter	Select Choice
UTILITY	PRINTER SETUP	Baud Rate	1200
			2400
			4800
			9600
		Stop Bits	1
			2
		Parity	None
			Odd
			Even
		Flow Control	None
			Software
			Hardware
			H/W & S/W

Setting the Print User & Company Text

You can have the CTS 710 include text on a printout that identifies the user name and company name. Including this text is optional.

To set the user name and company name:

Press Menu Button	Select Menu Page	Highlight Parameter	Select Choice
UTILITY	PRINTER SETUP	Print User & Company	On
			Off
		User Name	EDIT TEXT
		Company Name	EDIT TEXT

- The User Name and Company Name fields are 20 characters long. Select **DONE** when you are finished editing the name.

Setting Remote Control Parameters

You can control the CTS 710 using a General Purpose Interface Bus (GPIB) or an RS-232 connection. For information on remote control commands, refer to the *CTS 710 Programmer Manual*.

Setting the GPIB Address

To set the CTS 710 GPIB address:

Press Menu Button	Select Menu Page	Highlight Parameter	Select Choice
UTILITY	REMOTE CONTROL	GPIB Primary Address (see Figure 3-68)	Default 4
			Inc
			Dec
			Offline

- Select **Default 4** to set the GPIB address to its default value.
- Select **Inc** to increment the GPIB address.
- Select **Dec** to decrement the GPIB address.
- Select **Offline** to place the CTS 710 in the offline state.
- The maximum GPIB address value is 30. The minimum GPIB address value is 0.

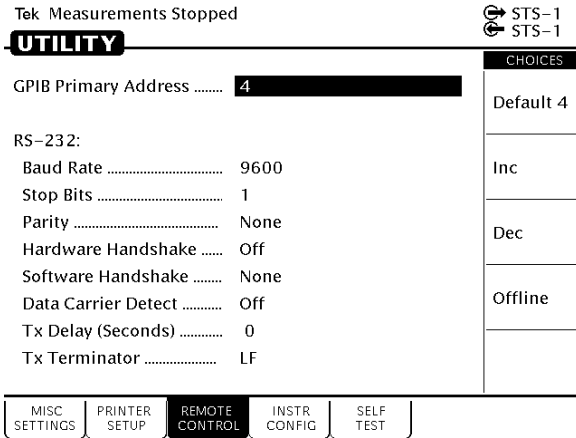

Figure 3-68: The REMOTE CONTROL Page

Setting RS-232 Parameters

The appropriate settings for RS-232 parameters depend on how the controller is set up. Refer to the user manual that came with your controller to determine the correct settings.

To set the remote control RS-232 parameters:

Press Menu Button	Select Menu Page	Highlight Parameter	Select Choice
UTILITY	REMOTE CONTROL (see Figure 3-68)	Baud Rate	1200
			2400
			4800
			9600
		Stop Bits	1
			2
		Parity	None
			Odd
			Even
		Hardware Handshake	Off
			On
		Software Handshake	None
			Xon/Xoff
		Data Carrier Detect	Off
			On
		Tx Delay (Seconds)	0
			1
			5
			Inc
			Dec

Press Menu Button	Select Menu Page	Highlight Parameter	Select Choice
		Tx Terminator	LF
			CR
			CR/LF
			LF/CR

- For Tx Delay, select one of the preset choices or use **Inc** and **Dec** to specify a value different from the preset choices.
- The maximum value for Tx Delay is 60. The minimum value is 0.

Running Instrument Self Tests

The CTS 710 provides self-contained tests that can be run any time you suspect the CTS 710 may not be performing properly.

The only test you might need to perform is the Power up Self Test. The other self tests available for selection are for servicing the instrument. Complete details on the self tests are located in the *CTS 710 SONET Test Set & CTS 750 SDH Test Set Service* manual.

Running the Power Up Self Test

To run the power up self test:

Press Menu Button	Select Menu Page	Highlight Parameter	Select Choice
UTILITY	SELF TEST	Self Test Group	Power up Self Test
		Self Test Loop	Once
		Self Test Control	Run

- Select **Abort** to stop a self test in progress.

If your CTS 710 fails the self test, contact the nearest Tektronix Service Center.



Appendices

Appendix A: Menu Maps

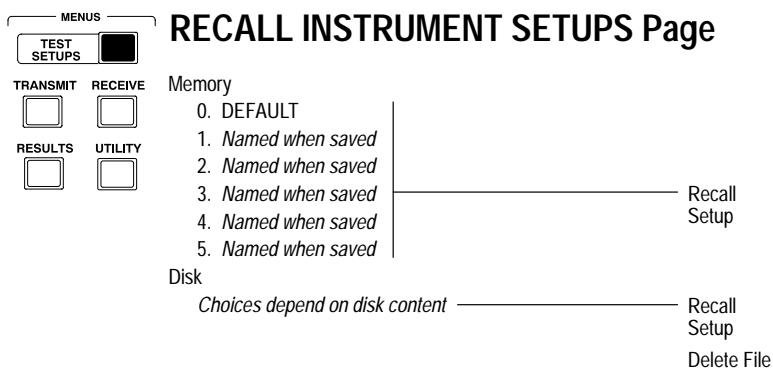
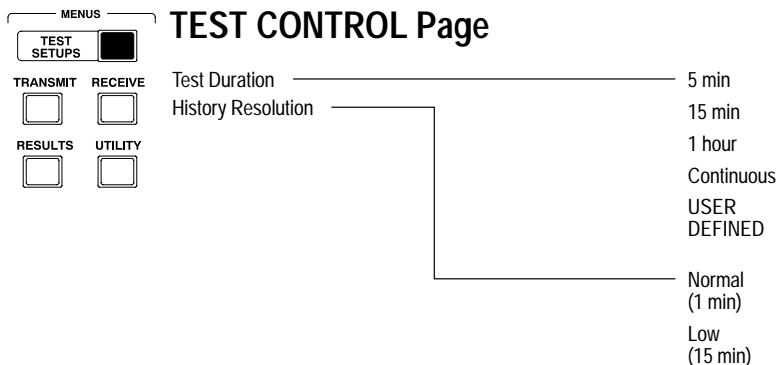

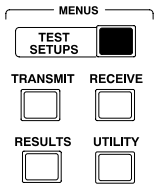

RECALL PASS/FAIL TESTS Page

Disk

Choices depend on disk content

- Recall & Run Test
- Delete File

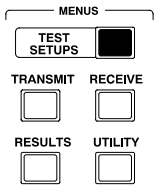

SAVE INSTRUMENT SETUPS Page

- Name ————— SETUP_XX
- Description ————— Clear
- Save to Memory ————— EDIT NAME
- Save To Disk ————— None
- Clear
- EDIT TEXT
- Memory 1
- Memory 2
- Memory 3
- Memory 4
- Memory 5
- Save File

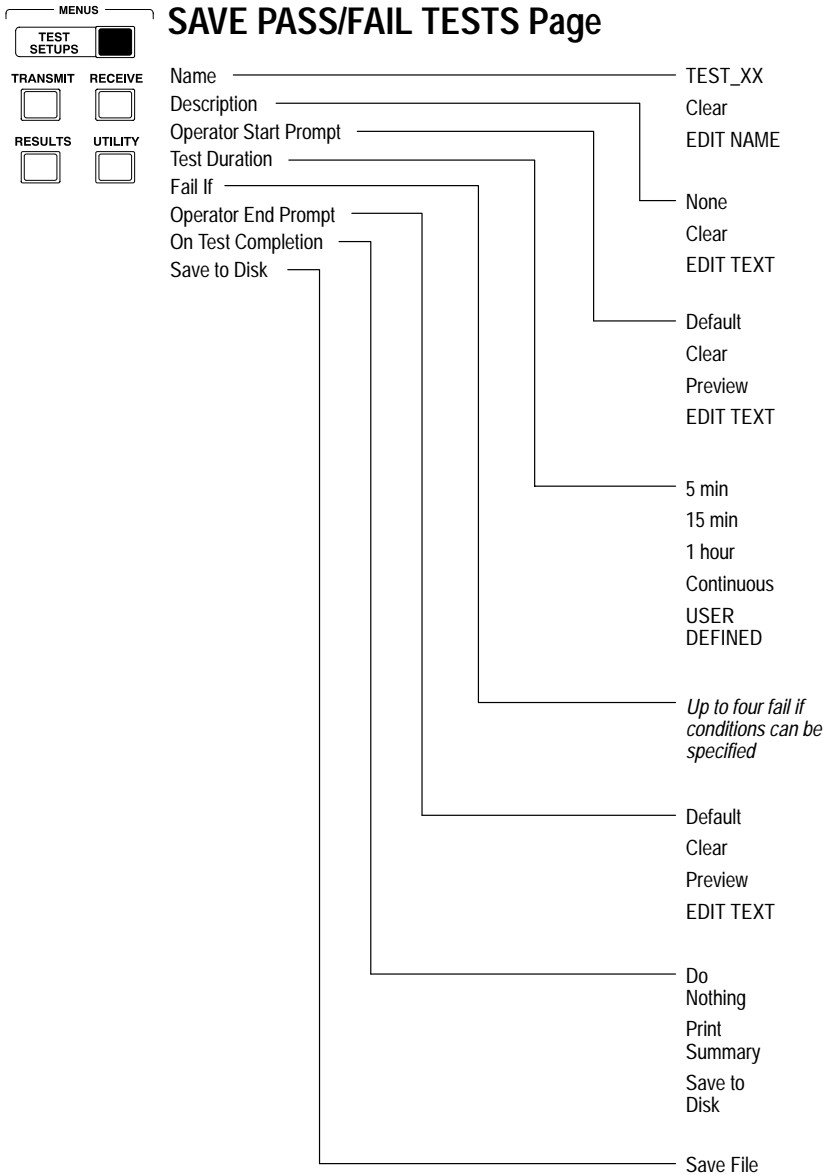

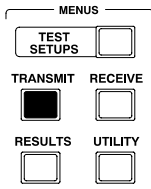

TRANSMIT SETTINGS Page (2 of 2)

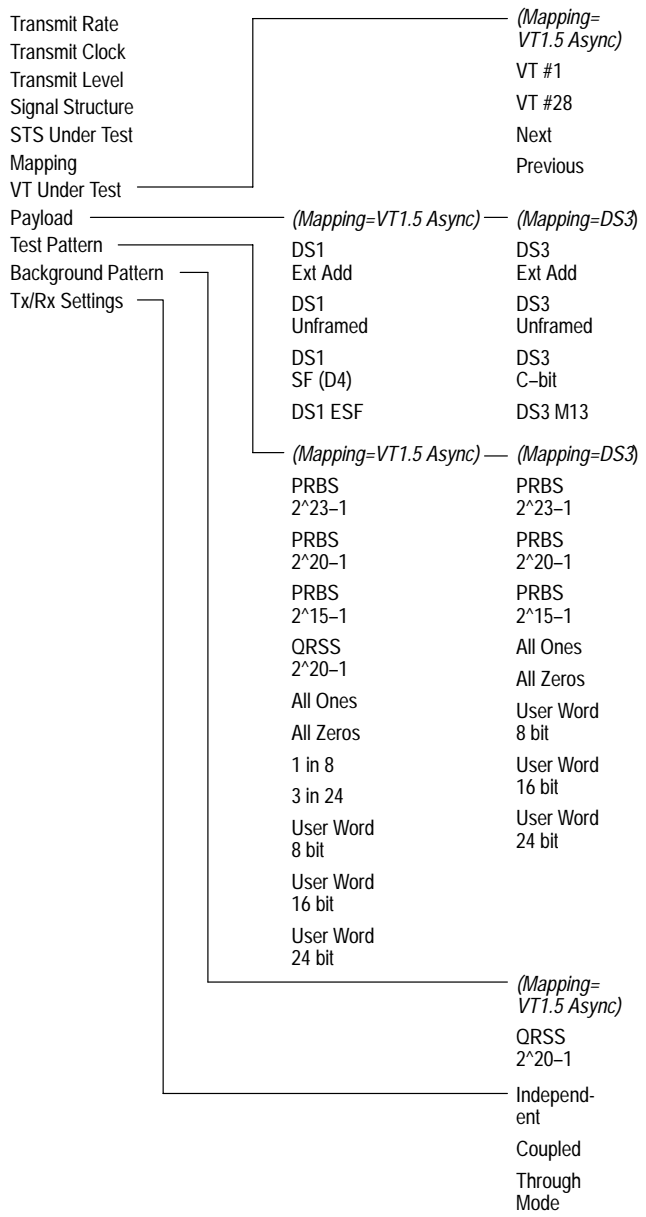

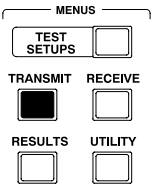

ERRORS & ALARMS Page (1 of 4)

Error Type set to	(Mapping= No Mapping)	(Mapping= VT1.5 Async)	(Mapping=DS3)
Error Rate set to			None
Transmit Alarm set to	Section B1	None	Section B1
Transmit Failure set to	Line B2	Section B1	Line B2
	Path B3	Line B2	Path B3
	Path FEBE	Path B3	Path FEBE
	Pattern Bit	Path FEBE	Pattern Bit
		VT BIP	
		VT FEBE	
		Pattern Bit	
		(Mapping=VT1.5 Async & Payload=DS1 SF (D4))	(Mapping=DS3 & Payload=DS3 C-bit)
		None	None
		Section B1	Section B1
		Line B2	Line B2
		Path B3	Path B3
		Path FEBE	Path FEBE
		Frame Bit	Frame Bit
		VT BIP	Pattern Bit
		VT FEBE	C-Bit
		Pattern Bit	
		(Mapping=VT1.5 Async & Payload=DS1 ESF)	(Mapping=DS3 & Payload=DS3 M13)
		None	None
		Section B1	Section B1
		Line B2	Line B2
		Path B3	Path B3
		Path FEBE	Path FEBE
		Frame Bit	Frame Bit
		VT BIP	Pattern Bit
		VT FEBE	P-Bit
		Pattern Bit	
		CRC (ESF)	

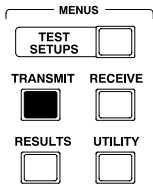

ERRORS & ALARMS Page (2 of 4)

Error Type set to	
Error Rate set to	None
Transmit Alarm set to	1e-3
Transmit Failure set to	1e-4
	1e-5
	1e-6
	1e-7
	1e-8
	USER DEFINED

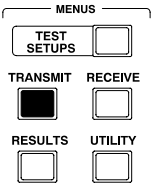

ERRORS & ALARMS Page (3 of 4)

Error Type set to

Error Rate set to

Transmit Alarm set to — (Mapping= — (Mapping= — (Mapping=DS3)

Transmit Failure set to

No Mapping)

VT1.5 Async & Payload=DS1 Ext Add)

(Mapping=DS3)

None

None

Line AIS

Line AIS

Line FERF

Line FERF

Path AIS

Path AIS

Path FERF

Path FERF

Path AIS

Path FERF

VT AIS

VT FERF

(Mapping=VT1.5 Async & Payload=DS1 Unframed)

(Mapping=DS3 & Payload=DS3 C-bit or DS3 M13)

None

None

Line AIS

Line AIS

Line FERF

Line FERF

Path AIS

Path AIS

Path FERF

Path FERF

VT AIS

DSn Yellow

VT FERF

DSn AIS

DSn AIS

DSn Idle

(Mapping=VT1.5 Async & Payload=DS1 SF (D4) or DS1 ESF)

None

Line AIS

Line FERF

Path AIS

Path FERF

VT AIS

VT FERF

DSn Yellow

DSn AIS

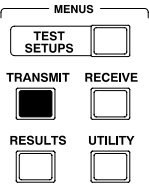

ERRORS & ALARMS Page (4 of 4)

Error Type set to
 Error Rate set to
 Transmit Alarm set to
 Transmit Failure set to — (Mapping= No Mapping) — (Mapping= VT1.5 Async) — (Mapping=DS3)

None	None	None
LOS	LOS	LOS
LOF	LOF	LOF
STS LOP	STS LOP	STS LOP
	VT LOP	
	VT LOM	

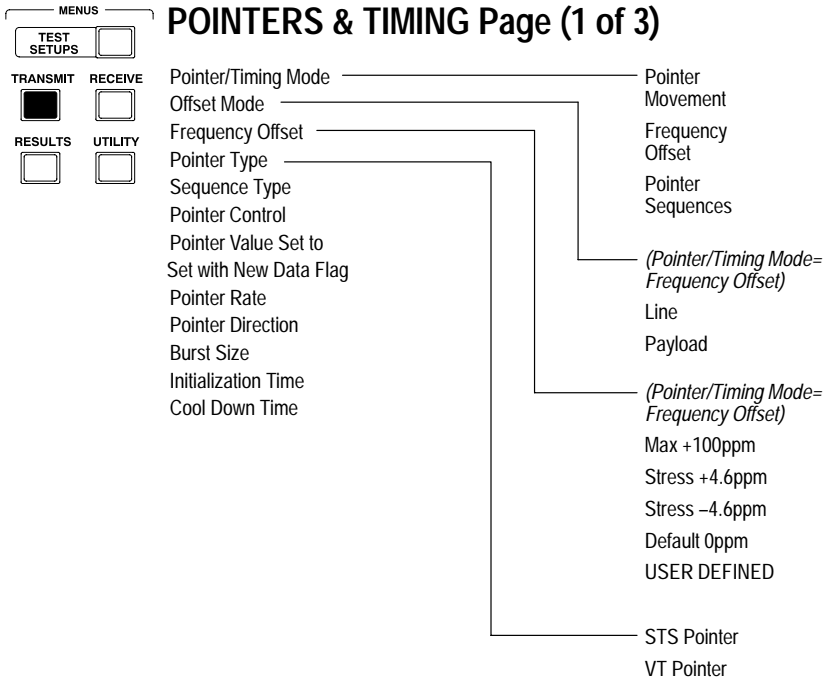

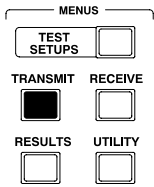

POINTERS & TIMING Page (2 of 3)

Pointer/Timing Mode	(Pointer/Timing Mode=	(Pointer/Timing Mode=
Offset Mode	Pointer Sequences &	Pointer Sequences &
Frequency Offset	Pointer Type=	Pointer Type=
Pointer Type	STS Pointer)	VT Pointer)
Sequence Type	Single	Single
Pointer Control	Burst	Burst
Pointer Value Set to	Phase	Phase
Set with New Data Flag	Transient	Transient
Pointer S-Bits	Periodic	Periodic
Pointer Rate	Continuous	Continuous
Pointer Direction	Periodic	Periodic
Burst Size	Continuous	Continuous
Initialization Time	With Cancel	With Cancel
Cool Down Time	Periodic	Periodic
	Continuous	Continuous
	With Add	With Add
	Periodic	Periodic
	87-3	26-1
	Periodic	Periodic
	87-3	26-1
	With Cancel	With Cancel
	Periodic	Periodic
	87-3	26-1
	With Add	With Add
	Single	Single
	Alternating	Alternating
	Double	Double
	Alternating	Alternating
	Single	
	Burst	
	Set Value	
	Continuous	
	(Pointer Control=Set Value)	
	Min 0	
	Max 782	
	Default	
	522	
	Illegal	
	(Max +1)	
	USER	
	DEFINED	

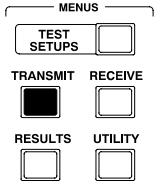

POINTERS & TIMING Page (3 of 3)

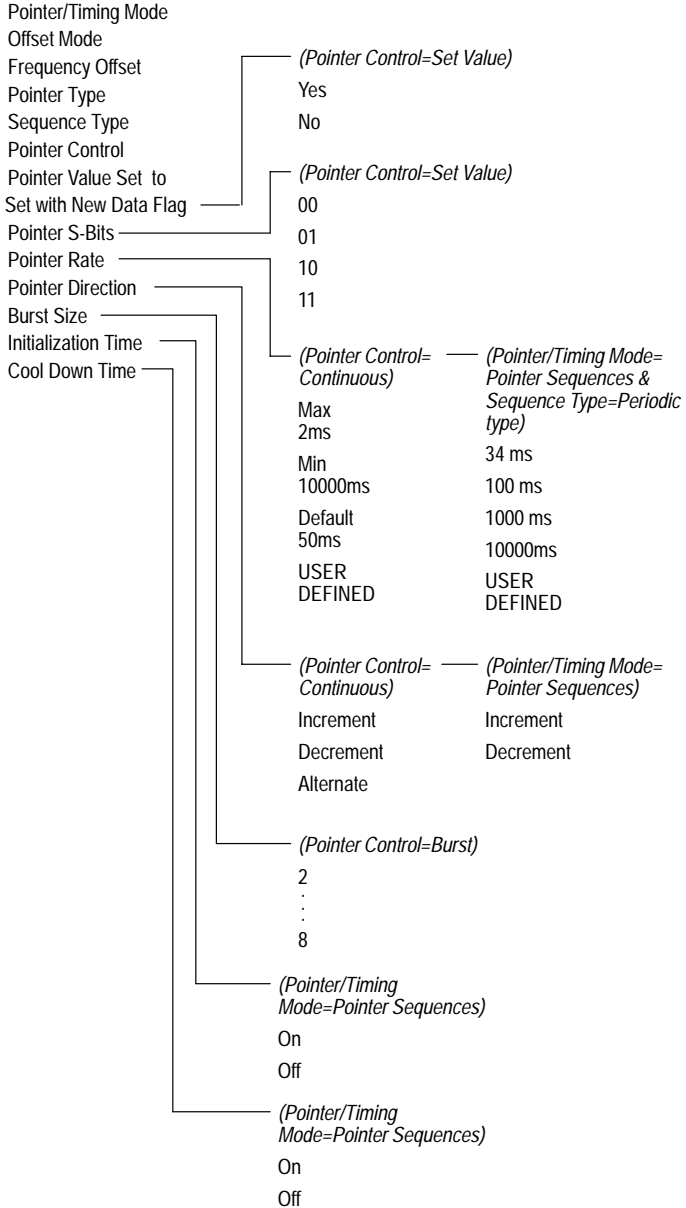

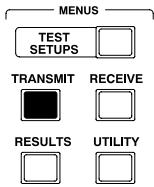

APS COMMANDS Page (1 of 3)

APS Mode	Span	
K1 Full Byte	Ring	
Bits 1-4:		
Bits 5-8:	Set to	
K2 Full Byte	00000000	
Bits 1-4:	Set to	
Bit 5:	11111111	
Bits 6-8:	Default	
Transmit Setup	10101010	
	EDIT BYTE	
	<i>(APS Mode=Ring)</i>	<i>(APS Mode=Span)</i>
	NR No Request	NR No Request
	RR-R Reverse Request Ring	DNR Do Not Revert
	RR-S Reverse Request Span	RR Reverse Request
	EXER-R Exerciser Ring	Not Used
	EXER-S Exerciser Span	EXER Exerciser
	WTR Wait To Restore	Not Used
	MS-S Manual Switch Ring	WTR Wait to Restore
	MS-S Manual Switch Span	Not Used
	SD-R Signal Degrade Ring	MS Manual Switch
	SD-S Signal Degrade Span	Not Used
	SD-P Signal Degrade Protection	SD Signal Degrade Low
	SF-R Signal Fail Ring	SD Signal Degrade High
	SF-S Signal Fail Span	SF Signal Fail Low
	FS-R Forced Switch Ring	SF Signal Fail High
	FS-S Forced Switch Span	FS Forced Switch
	LP-S Lockout of Protection Span	LP Lockout of Protection

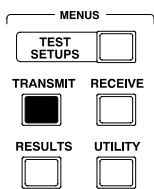

APS COMMANDS Page (2 of 3)

APS Mode	
K1 Full Byte	
Bits 1-4:	
Bits 5-8:	————— #0 (0000)
K2 Full Byte	————— #1 (0001)
Bits 1-4:	————— #2 (0010)
Bit 5:	————— #3 (0011)
Bits 6-8:	————— #4 (0100)
Transmit Setup	————— #5 (0101)
	————— #6 (0110)
	————— #7 (0111)
	————— #8 (1000)
	————— #9 (1001)
	————— #10 (1010)
	————— #11 (1011)
	————— #12 (1100)
	————— #13 (1101)
	————— #14 (1110)
	————— #15 (1111)
	Set to 00000000
	Set to 11111111
	Default 10101010
	EDIT BYTE

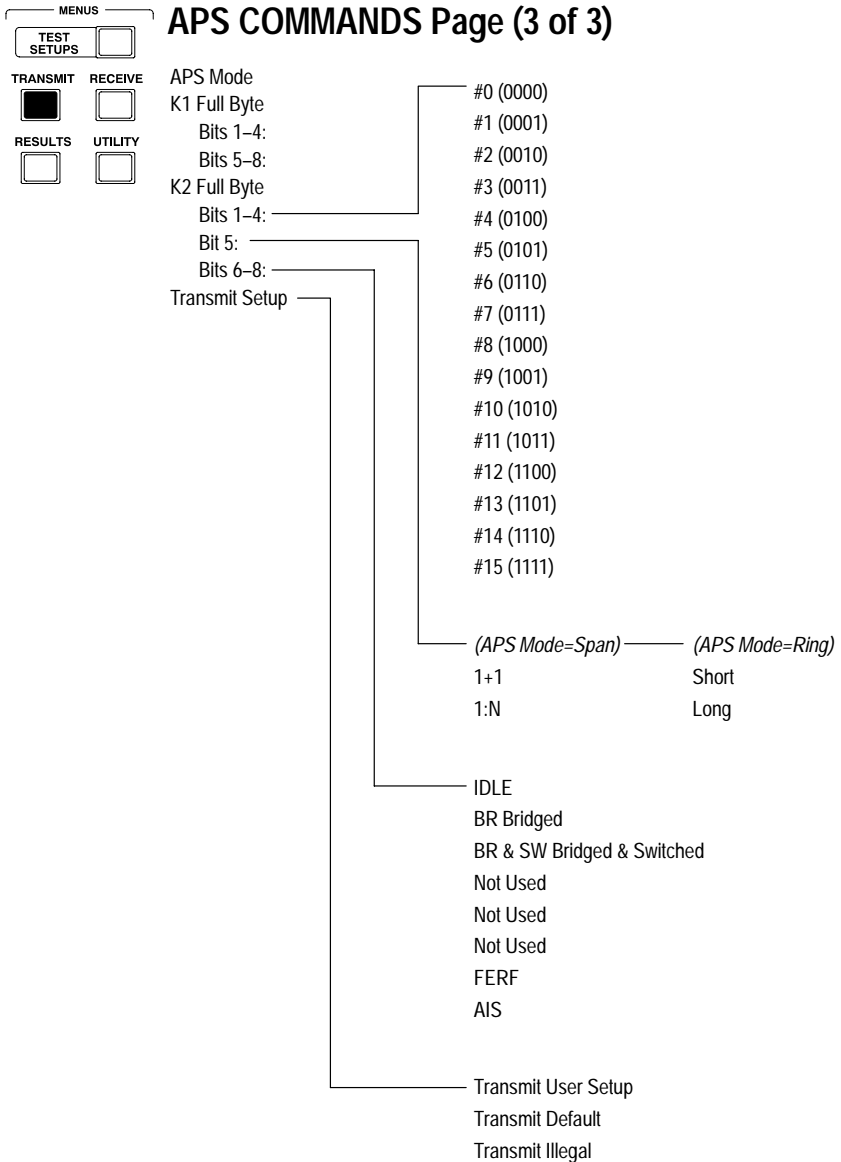

MENUS

TEST SETUPS

TRANSMIT RECEIVE

RESULTS UTILITY

PATH OVERHEAD Page

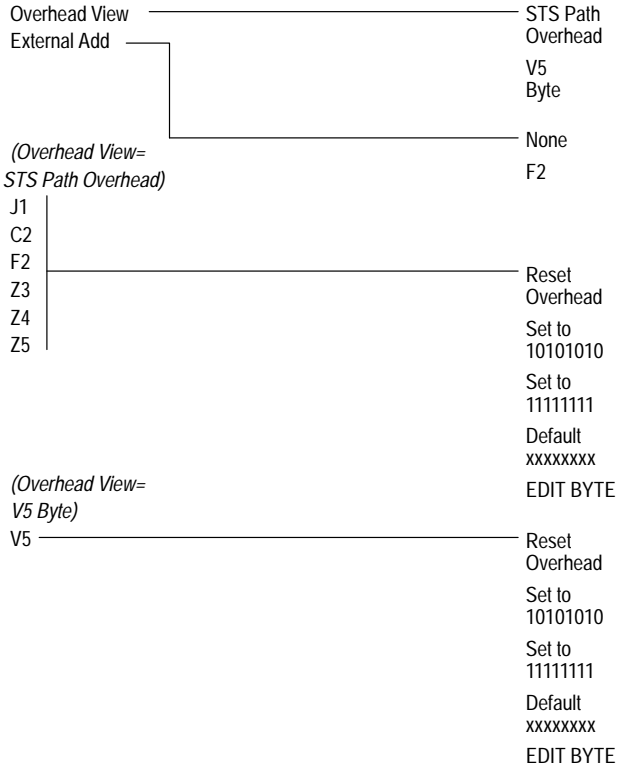

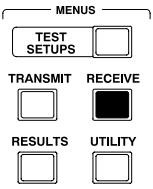

RECEIVE SETTINGS Page (1 of 2)

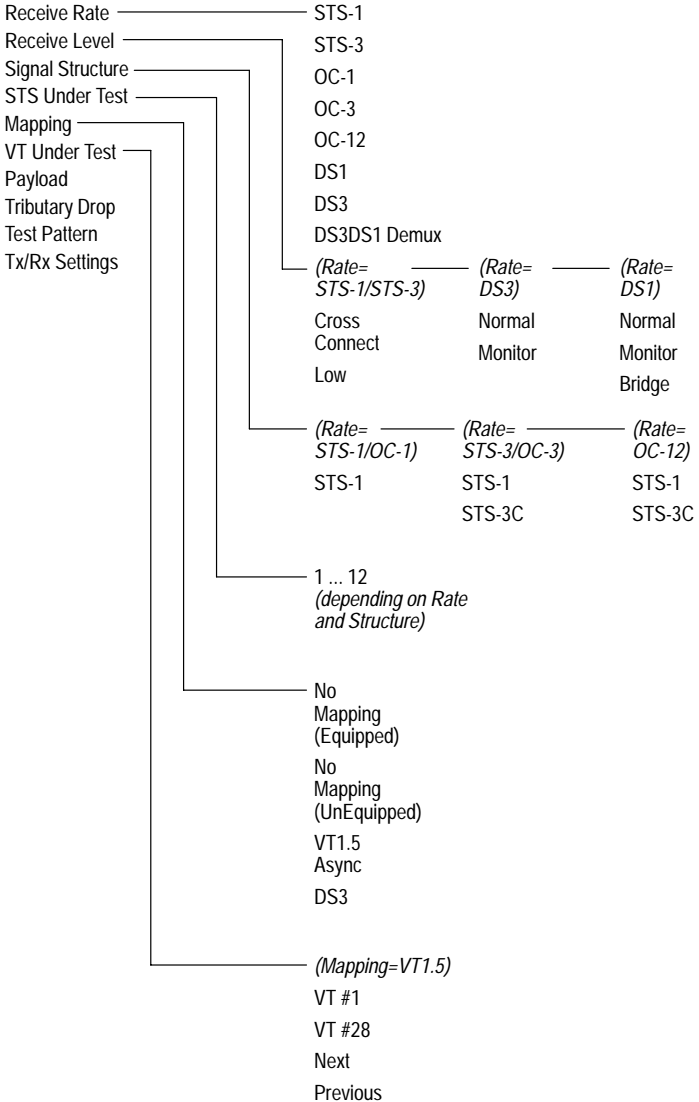

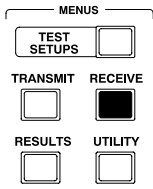

RECEIVE SETTINGS Page (2 of 2)

Receive Rate	(Mapping=DS3)	(Mapping=VT1.5)	
Signal Structure	DS3	DS1	
STS Under Test	Unframed	Unframed	
Mapping	DS3 C-bit	DS1 SF (D4)	
VT Under Test	DS3 M13	DS1 ESF	
Payload			
Tributary Drop	(Mapping=DS3)	(Mapping=VT1.5)	
Test Pattern	On	On AMI	
Tx/Rx Settings	Off	On B8ZS	
		Off	
	(Mapping= No Mapping)	(Mapping=VT1.5 Rate=DS3)	(Mapping= DS3)
	PRBS 2^23-1	PRBS 2^23-1	PRBS 2^23-1
	PRBS 2^20-1	PRBS 2^20-1	PRBS 2^20-1
	PRBS 2^15-1	PRBS 2^15-1	PRBS 2^15-1
	PRBS 2^09-1	QRSS 2^20-1	All Ones
	All Ones	All Ones	All Zeros
	All Zeros	All Zeros	User Word 8 bit
	User Word	1 in 8	User Word 16 bit
	Unknown	3 in 24	User Word 24 bit
		User Word 8 bit	Unknown
		User Word 16 bit	
		User Word 24 bit	
		Unknown	
			Independent
			Coupled
			Through Mode

SIGNAL STATUS Page

MENU

TEST SETUPS

TRANSMIT RECEIVE

RESULTS UTILITY

Expected Receive Rate
 Received Optical Power
 Received Peak Voltage

TRANSPORT OVERHEAD Page

MENU

TEST SETUPS

TRANSMIT RECEIVE

RESULTS UTILITY

Showing Overhead for _____

External Drop _____

Pause Control _____

Choices depend on receive rate

- None
- D1-D3
- D4-D12
- F1
- Pause
- Continue

A1	A2	C1	<i>Bytes that can be viewed on this page</i>
B1	E1	F1	
D1	D2	D3	
H1	H2	H3	
B2	K1	K2	
D4	D5	D6	
D7	D8	D9	
D10	D11	D12	
S1	M0	E2	

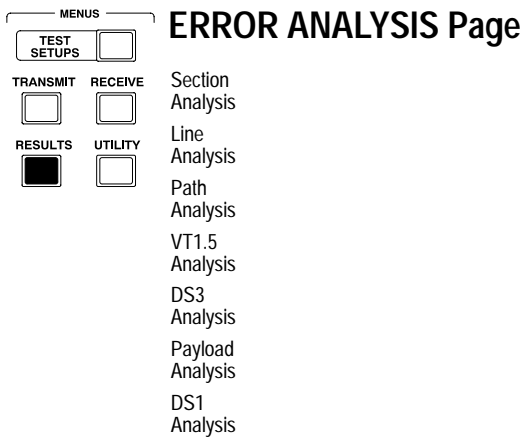
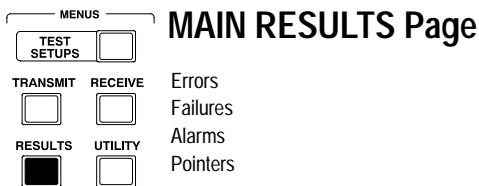

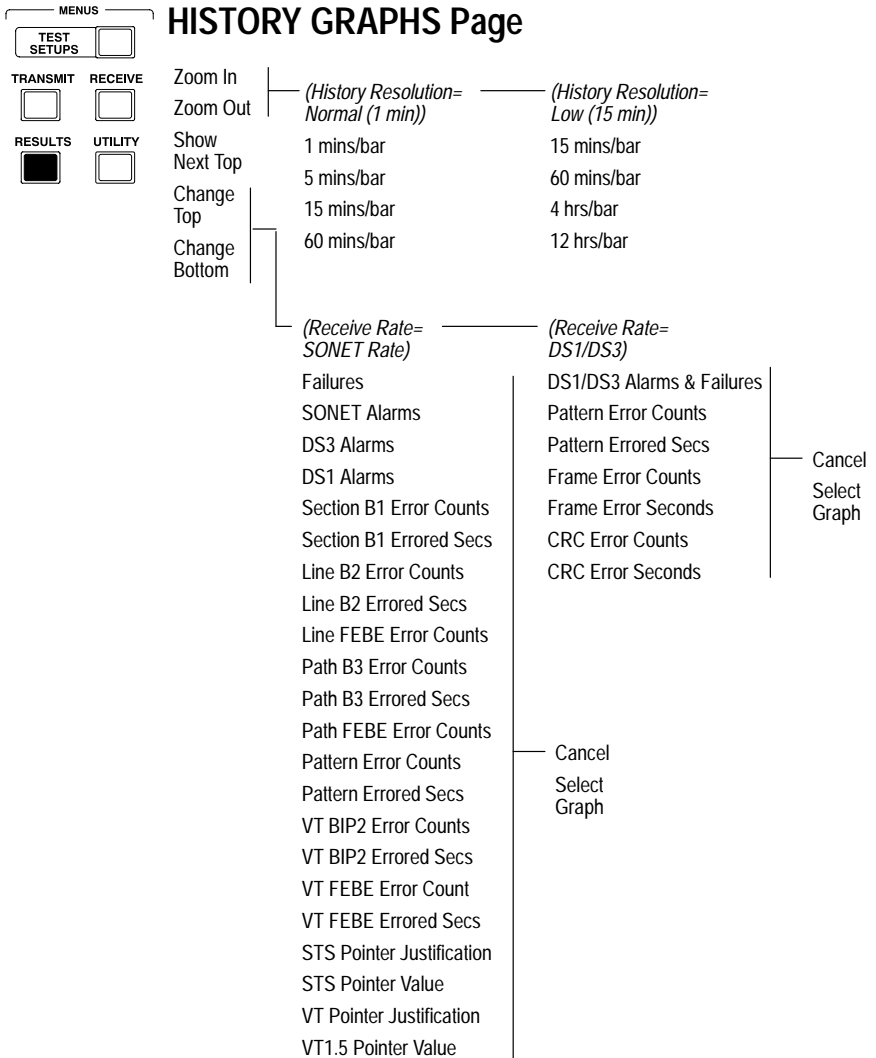

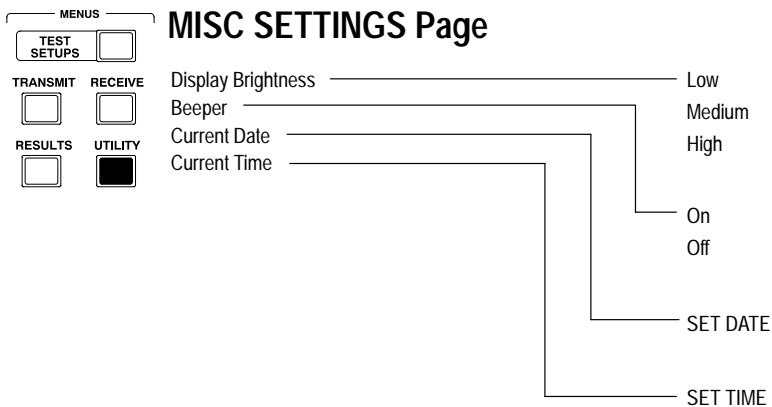
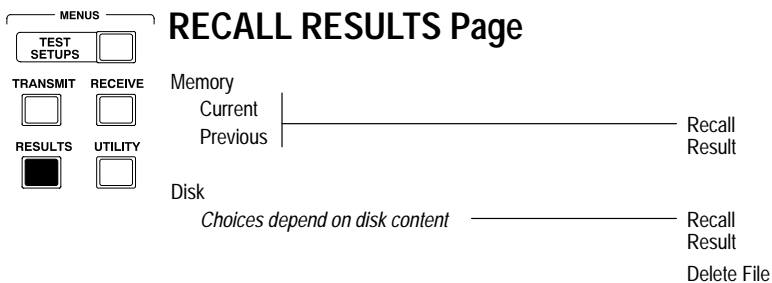
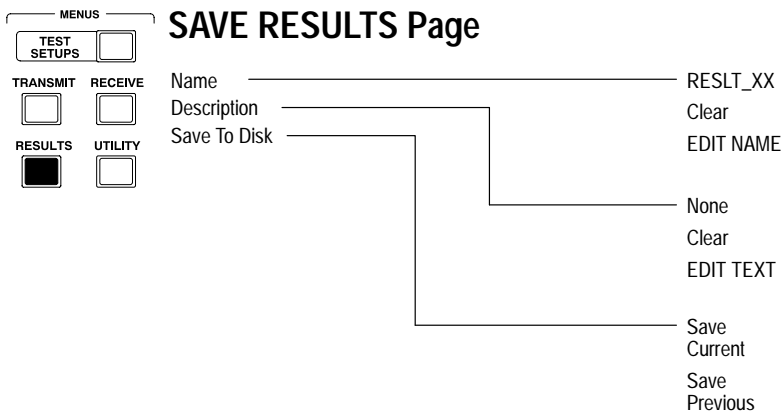

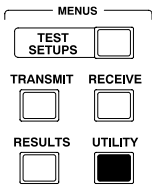

PRINTER SETUP Page

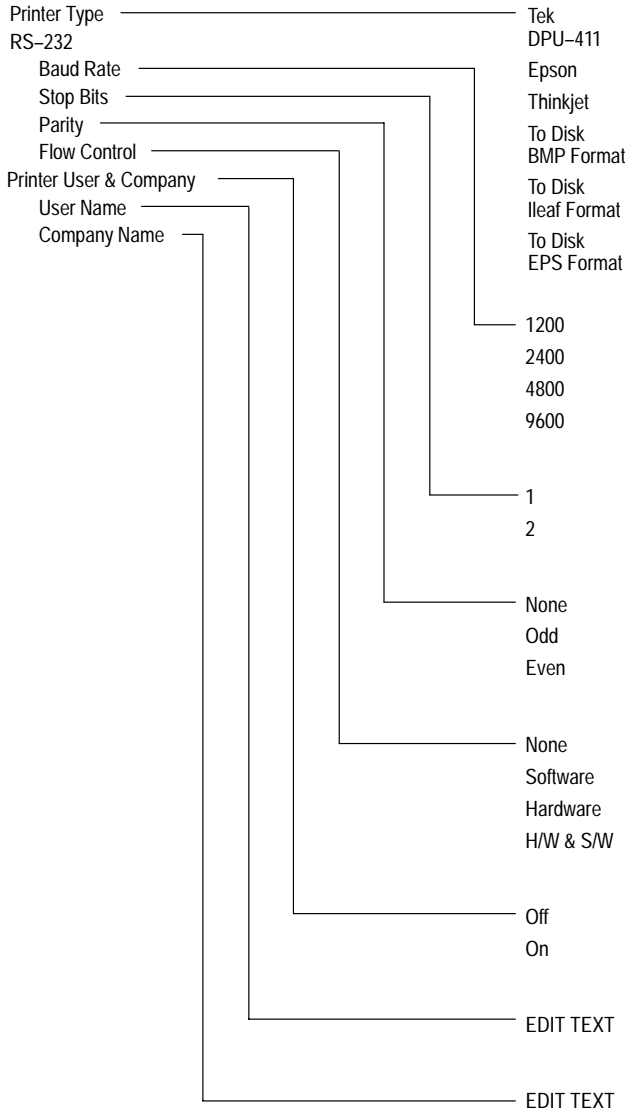

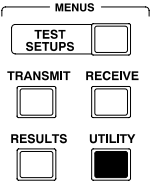

REMOTE CONTROL Page

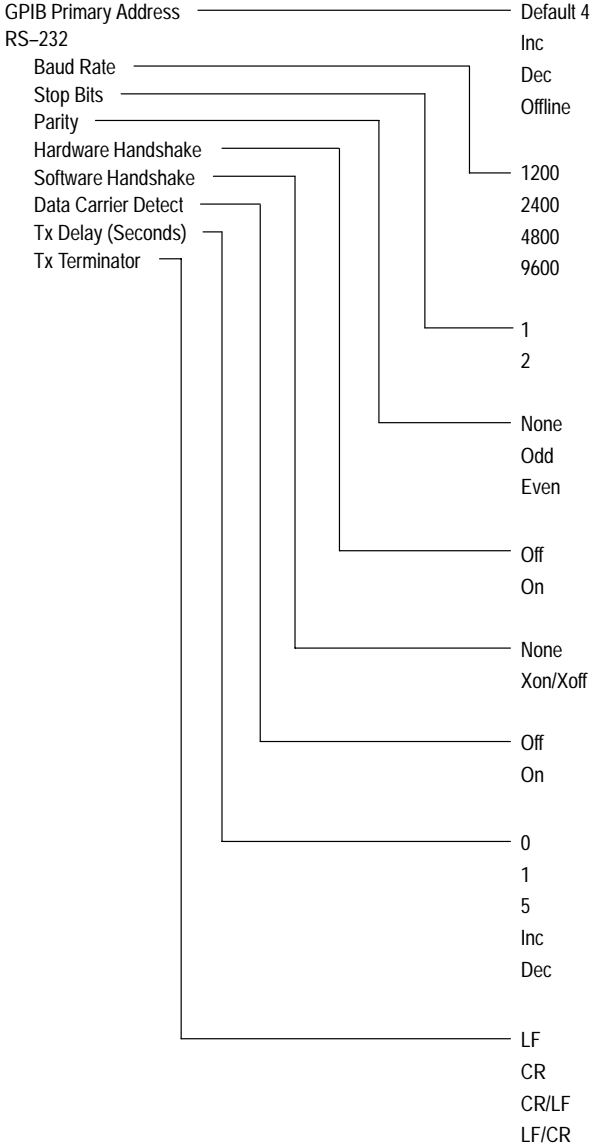

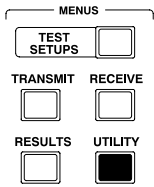

INSTR CONFIG Page

Model:
 Serial Number:
 Hardware Revision:
 Option Revision:
 Firmware Revision:
 Options:
 Interface Module:
 DS1/DS3 Option:

Displayed information depends on instrument

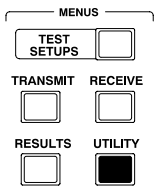

SELF TEST Page

Self Test Control
 Self Test Group
 Self Test Routine
 Self Test Loop control
 View Results

Run
 Abort
 Self Test
 SYS Int.
 SYS Ext.
 Protocol Bd
 Clock Bd
 O/E Mod.
 Tributary
 CPU
 Display
 Front Panel
 Disk
 All
 Once
 Ten
 Thousand
 Until Error
 Forever
 Page Up
 Page Down

Appendix B: Status and Error Messages

This appendix describes the status and error messages that appear on the CTS 710 display. Status messages are statements about actions the CTS 710 has completed. Status messages appear during normal operation. Error messages are statements about actions the CTS 710 was unable to complete. Error messages appear when the CTS 710 is unable to perform a requested action.

Status Messages

Autoscan complete. The CTS 710 has successfully completed the Autoscan sequence.

Burst pointer movement transmitted. The POINTER ACTION button was pressed with the Pointer Control set to Burst.

Disk root directory read. The CTS 710 has successfully read the disk directory.

Factory settings restored, non-volatile settings cleared. This message appears when the instrument is turned on after it was turned off during a state change. The instrument settings were corrupted during the shutdown and so the factory default settings were loaded at turn-on and all information stored in RAM was cleared.

File has been deleted. The CTS 710 has successfully deleted the selected file.

Hardcopy complete. The CTS 710 has successfully completed a printout.

Instrument factory reset complete. The recall of default factory settings, from the RECALL INSTRUMENT SETUP page, was completed successfully.

Instrument returned to previous setup. This message appears if you select Cancel while an Autoscan is in progress.

Instrument setup for received signal. The CTS 710 has completed an Autoscan and has changed its settings to match those of the received signal.

Internal diagnostics completed. An instrument self test has been initiated and completed successfully.

No Setup file with '.SET' extension found. You selected the Disk action on the RECALL INSTRUMENT SETUP page and no instrument setup files were found on the disk.

Previous power down instrument state restored. This message appears when the CTS 710 turns on. It means that the settings in effect when the CTS 710 was last turned off have been successfully restored.

Reading disk.... The CTS 710 is reading the disk directory.

Recall of instrument setup complete. This message confirms that the recall of an instrument setup was successfully completed.

Recall of measurement results/histories complete. The CTS 710 has successfully recalled the selected results from disk.

Recall of pass/fail test complete. The CTS 710 has successfully recalled the selected pass/fail test from disk.

Save of instrument setup complete. This message confirms that an instrument setup was successfully written to disk.

Save of measurement results/histories complete. The CTS 710 has successfully saved test results to disk.

Save of pass/fail test complete. The CTS 710 has successfully saved the pass/fail test to disk.

Single pointer movement transmitted. You pressed the POINTER ACTION button with the Pointer Control set to Single.

Test restarted due to change in receiver settings. You changed the receive settings while a test was running. When any settings are changed, a running test is restarted.

Transmit rate change complete. The CTS 710 has successfully changed transmit rate. This message can occur when an instrument setup file is recalled from disk.

Error Messages

Alarm generation invalid while in through mode. You attempted to transmit an alarm while the CTS 710 was in Through Mode. Transmit settings cannot be changed while the transmit rate is set to Through Mode.

Autoscan already in progress. You pressed the Autoscan front-panel button while an Autoscan was in progress.

Button disabled in edit mode. You pressed a front-panel button while the CTS 710 was in edit mode. You must exit edit mode before you can use the front-panel buttons.

Button disabled when dialog box is displayed. You pressed a front-panel button while a dialog box (for example, PRINT CONTROL) was displayed. Some front-panel buttons are disabled while a dialog box is displayed. Exit the dialog box to enable all the front-panel buttons.

Can not insert tributary error/alarm while adding external signal. An attempt was made to insert a tributary error or alarm while adding an external signal.

Could not create disk file. The CTS 710 was unable to create a file on the disk. Try saving the file on a different disk.

Could not delete file. You attempted to delete a file and a disk error occurred that prevented the CTS 710 from deleting the file. The file is probably corrupted, though you might be able to fix the problem with an MS-DOS disk recovery program.

Could not open disk file. The CTS 710 has attempted to read a file from disk and was unable to do so. The file is probably corrupted, though you might be able to recover the file using an MS-DOS file recovery program.

Could not read disk's root directory. The CTS 710 was unable to read the disk directory. The disk directory is probably corrupted, though you might be able to recover files from the disk with an MS-DOS disk recovery utility.

Diagnostics invalid while disk or autoscan busy. You tried to run Self Test diagnostics while accessing the disk or completing an Autoscan. Wait until disk access is complete or the Autoscan is complete before running a self test routine.

Disk file too large for memory buffer, truncated. You recalled a file and it was too large to load into memory. This can occur if an instrument settings file is recalled that has been edited on a PC and the edited file is larger than the original file.

Disk has changed, operation aborted. You attempted to recall a disk file and the disk has been changed since the directory was read. Reinsert the original disk and recall the file again.

Disk is busy. You tried to save a file to disk while the disk was active. Wait until the disk activity light turns off and save to disk again.

Disk is full. You tried to save a file to disk and there is not enough room on the disk for the file. Insert a disk with space available and save the file again.

Disk not present in drive. You tried to save a file to disk, but no disk is in the drive. Insert a formatted disk and save the file again.

Disk is write-protected, cannot write to file. You tried to save a file to a disk that is write-protected.

Disk operation failed. A disk error occurred while reading or writing to the disk. If you were trying to save a file to disk, save the file to a different disk. If you were trying to read a file from disk, you might be able to recover the file using an MS-DOS disk recovery program.

Error insertion disabled while in Through Mode. You pressed the INSERT ERROR button while the CTS 710 was in Through Mode. You cannot insert errors while the CTS 710 is in Through Mode because the transmit signal must match the received signal.

Errors in test recall, test not loaded. The CTS 710 encountered disk errors while recalling a pass/fail test and the operation was aborted. You might be able to recover the file with an MS-DOS disk recovery program.

Extra data in history file ignored. You recalled a history file that contains extra data. This can occur if the history file has been edited with a file editor and the edited file contains inappropriate information.

Failure generation invalid while in through mode. You attempted to transmit a failure while the CTS 710 was in Through Mode. Transmit settings cannot be changed while the transmit rate is set to Through Mode.

File name required. You entered a name for an instrument setup, a pass/fail test, or a results file and then you removed the name by selecting Clear. This message is just a reminder that a name must be

entered for the file to be saved to disk; that is, there is no default file name.

Filename not found. This message appears if the disk was swapped after the directory was read and you attempted to recall a file. Insert the original disk and recall the file again.

File not read. A disk error occurred while reading a file. The file is probably corrupted, though you might be able to recover the file with an MS-DOS disk recovery program.

Frequency offset disabled with current transmit clock. You attempted to change from Pointer/Timing Mode to Frequency Offset while the transmit clock was set to External. Frequency Offset can be selected only when the transmit clock is set to Internal or Recovered.

Hardcopy already in progress. You tried to start a printout while a printout was already in progress. Wait until the current printout completes and then select Print again.

Instrument unable to drop signal while transmitting current rate. You attempted to turn on tributary drop while the transmit rate was set to a tributary rate. Because the tributary transmit connector and tributary drop connector are the same connector, you cannot transmit a tributary signal and drop a tributary signal at the same time.

Internal diagnostics failed. A malfunction has occurred that requires servicing. Contact a Tektronix representative for assistance.

Internal Error N: Contact Tektronix Service. A hardware malfunction has occurred that requires servicing. Contact a Tektronix representative for assistance.

Internal format of file incorrect; file not read. You recalled a file that does not contain data in the correct format. This occurs when a file is recalled that happens to have the same extension as the type of CTS 710 file being recalled, but it is not a CTS 710 file.

Invalid history data format in file. You recalled a file that does not contain data in the correct format. This occurs when a file is recalled that happens to have the correct extension for a history file (and thus shows up on the RECALL RESULTS page) even though it is not a CTS 710 history file.

Loss of added signal. You have selected an externally generated tributary signal, but no valid signal is present.

Loss of external clock. You have selected an external clock source that does not have a valid clock source attached.

Measurements are running, recall not allowed. You tried to recall instrument setups from memory or disk while a test is running. Wait until the test is completed and then recall the file.

Measurements are running, results cannot be saved. You attempted to save results to disk while a test was running. Wait until the test is completed and then save the results to disk.

No Result file with '.RES' extension found. This message appears when you select Disk (on the RECALL RESULTS page) but the disk does not contain any results files.

Not available without tributary option. The requested action requires that the Add/Drop/Test tributary option be installed.

No Test file with '.TST' extension found. This message appears when you select Disk (on the RECALL PASS/FAIL TESTS page) but the disk does not contain any pass/fail test files.

Numeric value greater than maximum limit. You attempted to enter a numeric value larger than the maximum value.

Numeric value less than minimum limit. You attempted to enter a numeric value smaller than the minimum value.

Operation invalid while a test is running. You tried to perform an action that cannot be completed while a test is running. For example, this message would appear if you attempted to recall instrument settings while a test is running.

Optical power has been overloaded. You have connected an optical signal that has saturated the CTS 710 optical receiver.

Pointer burst active, request ignored. You pressed the POINTER ACTION button while a pointer burst movement was occurring.

Pointer movements disabled while in Through Mode. You pressed the POINTER ACTION button while the CTS 710 was in Through Mode. Pointer movements are not allowed while the CTS 710 is in Through Mode because the transmit signal must match the received signal.

Root directory is full. You tried to save a file to disk but the directory shows that the disk is full. Insert a disk with space available and save the file again.

Through Mode invalid while receiving a tributary signal. You attempted to change the transmit rate to Through Mode while a test was running at a tributary rate. Any change in settings would invalidate the test, so no change was made.

Unexpected End Of File, file not read. You tried to recall an instrument setup file, a pass/fail file, or a history file and a disk error occurred. The file is corrupted and cannot be recovered.

Warning: No received signal currently identified. You started a test while there was no received signal.

Write Failure on Disk. The CTS 710 was unable to write to the disk. Try saving the file on a different disk.

Appendix C: Default Factory Settings

Table C-1 lists the instrument settings after Default Factory Settings have been recalled.

Table C-1: Default Factory Settings

Parameter	Default Value
Transmit Rate	STS-1
Transmit Clock	Internal
Transmit Level	Cross Connect
STS Under Test	1
Mapping	Bulk Fill No Mapping (Equipped)
Transmit Test Pattern	PRBS 2 ²³ -1
Transmit Overhead Path Trace	" " (64 null characters)
Transmit Overhead External Add	None
Transmit Error Rate	None
Transmit Error Type	Section B1 BIP Error
Transmit Alarm	None
Transmit Failure	None
Transmit Pointer/Timing Mode	Pointer Movements
Transmit Pointer Type	STS
Transmit Pointer Control	Single
Transmit Pointer Value	522
Transmit Pointer Set with New Data Flag	Yes
APS Mode	RING
Receive Rate	STS-1
Receive Level	Cross Connect

Table C-1: Default Factory Settings (Cont.)

Parameter	Default Value
Receive STS Under Test	1
Receive Mapping	No Mapping (Equipped)
Receive Tributary Drop	Off
Receive Test Pattern	PRBS 2 ²³ -1
Test Duration	Continuous
Receive Path Overhead External Drop	None
Beeper	Off
Display Brightness	Medium
Printer Type	TEK DPU-411
Print User & Company	Off

Appendix D: Specifications

Table D-1: Standard CTS 710 Specifications

Characteristic	Description
Generator Output	
Electrical Output	
Data Rates	STS-1: 51.84 Mb/s STS-3: 155.52 Mb/s
Data Formats	STS-1: AMI, B3ZS STS-3/STS-3c: CMI
Signal Level at Transmit Output	STS-1 Hi: ± 1.0 Vpk $\pm 10\%$ into 75 Ω with 450 feet of cable loss STS-1: ± 1.0 Vpk $\pm 10\%$ into 75 Ω with 450 feet of cable loss STS-3 Hi: ± 0.5 Vpk $\pm 10\%$ into 75 Ω with 225 feet of cable loss STS-3: ± 0.5 Vpk $\pm 10\%$ into 75 Ω with 225 feet of cable loss
Pulse Shape at Transmit Output	Meets ANSI T1-102, Bellcore GR-NWT-000253 Eye Pattern Masks
Return Loss	>15 dB
Connector	Unbalanced, 75 Ω BNC
Optical Output	
Data Rates	OC-1: 51.84 Mb/s OC-3: 155.52 Mb/s OC-12: 622.08 Mb/s
Optical Module Options	Opt. 03, 1310 nm, IR, OC-1/3 Opt. 04, 1310 nm, IR, OC-1/3/12 Opt. 05, 1550 nm, LR, OC-1/3/12 Opt. 06, 1310/1550 nm, OC-1/3/12
Signal Level & Wavelength	-10 dBm, typical 1310 nm (Opt. 03, 04, 06) 0 dBm, typical, 1550 nm (Opt. 05, 06)
Pulse Shape	Meets Bellcore GR-253-CORE Eye Pattern Masks
Wavelength	1308 nm, typical (Opt. 03, 04, 06) 1550 nm, typical (Opt. 05, 06)

Table D-1: Standard CTS 710 Specifications (Cont.)

Characteristic	Description
Spectral Width	≤ 4 nm, 1310 nm (Opt. 03, 04, 06) ≤ 1 nm, 1550 nm (Opt. 05, 06)
Laser Classification	Class 1 laser, complies with 21 CFR 1040.10 and 1040.11, complies with IEC 825, Section 9.4
Connectors	FC-PC Standard: Optical Connector kit with ST, SC, and DIN 47256 included
Signal Structure	
Standards Compliance	Meets the requirements of ANSI T1.105A, Section 8 and Bellcore GR-NWT-000253
Payload Channel (SPE)	One active STS-1 in STS-3 Selection (The other 2 channels are unequipped) One active STS-1 in STS-12 (The other 11 channels are unequipped) One active STS-3c in STS-12 (The other 3 channels are unequipped)
Unequipped Payload	C2 byte is set to 00
Internal Pattern Generator	
Patterns Bulk Fill in a selected SPE channel (STS-1 or STS-3c)	PRBS: 2 ⁹ -1, 2 ¹⁵ -1, 2 ²⁰ -1, 2 ²³ -1; All 1s, All 0s, 8-bit programmable word
Errors Single or Continuous	Section BIP (B1) Line BIP (B2) Path BIP (B3), Path FEBE Payload pattern bit
Error Rate Range	1 × 10 ⁻³ to 1 × 10 ⁻¹⁰ with 0.1 resolution ¹
Alarms	Line AIS, Line FERF Path AIS, Path FERF
Failures	LOS, LOF, LOP
Transmitter Clock	
Internal Clock	

¹ Depends on error type.

Table D-1: Standard CTS 710 Specifications (Cont.)

Characteristic	Description
Accuracy	± 4.6 ppm, for instrument calibrated within 24 months
External Clock Reference	
Rate	1.544 MHz ± 40 ppm
Input	Balanced, 100 Ω $\pm 5\%$, Bantam connector
Recovered Clock	
Loop timing	Clock is recovered from received signal
Transmit Line Frequency Offset	
Frequency offset rate	± 100 ppm of nominal line rate
Receive Input	
Electrical Input	
Data Rates	STS-1: 51.84 Mb/s ± 100 ppm STS-3: 155.52 Mb/s ± 100 ppm
Data Formats	STS-1E: AMI, B3ZS coded STS-3/STS-3c: CMI
Signal Sensitivity	STS-1 Hi: 0.5 Vpk min to 1.2 Vpk max STSX-1: 0.25 Vpk min to 0.6 Vpk max STS-1 Lo: 0.125 Vpk min to 0.35 Vpk max STS-1 Monitor: 20 dB of flat loss below Xcon STS-3: 0.35 Vpk min to 0.6 Vpk max STSX-3: 0.35 Vpk min to 0.6 Vpk max STS-1 Lo: 0.07 Vpk min to 0.3 Vpk max STS-3 Monitor: 26 dB of flat loss below Hi
Signal Level Display	Readout for: Electrical signal level in mV
Signal Equalization	STS-1: Cross-connect equalization for 450 feet of AT&T 728A cable Low-level equalization for 900 feet of AT&T 728A cable STS-3: Automatic equalization for 0 to 450 feet of cable loss to ITU-T Rec. G.708 and ANSI TI-102

Table D-1: Standard CTS 710 Specifications (Cont.)

Characteristic	Description
Return Loss	>15 dB
Connector	Unbalanced, 75 Ω BNC
Optical Input	
Data Rates	OC-1: 51.84 Mb/s (±100 ppm) OC-3: 155.52 Mb/s (±100 ppm) OC-12: 622.08 Mb/s (±100 ppm)
Maximum Input Power	-7 dBm: Opt. 05 and 06 include a 10 dB attenuator
Operating Wavelength	1310 nm and 1550 nm: 1100 nm to 1570 nm operating range
Signal Sensitivity	-28 dBm for BER ≤10 ⁻¹⁰
Optical Power Meter Accuracy	2 dBm, Typical: For input power in a range of -30 dBm to -6 dBm
Connectors	FC-PC standard: Optical connector kit with ST, SC, and DIN 27256 included
Through Mode	Monitors a selected channel and passes the signal through unchanged

Transmit and Receive Functional Specifications

Transport Overhead	
Access	Set overhead bytes to any value from binary 00000000 to 11111111: A1, A2, C1, E1, F1, D1-D3, K1, K2, D4-D12, S1, Z2, M2, E2 View all Transport Overhead bytes
Add/Drop	Insert data from the Overhead Add/Drop connector into the Section DCC, Line DCC or F1 user byte. Drops data from the Section DCC, Line DCC, or F1 user byte out to the Overhead Add/Drop connector.
K1 and K2 (APS)	Set the APS Bytes, K1 and K2, to any code defined in ANSI T1.105A Selectable by text description for all Span and Ring messages

Table D-1: Standard CTS 710 Specifications (Cont.)

Characteristic	Description
Path Overhead	
Access	Set Path Overhead bytes to any value from binary 00000000 to 11111111: C2, F2, Z3, Z4, and Z5 View all Path Overhead bytes
Add/Drop	Insert data from the Overhead Add/Drop connector into the F2 user byte Drop data from the F2 user byte out to the Overhead Add/Drop connector
Path Trace Byte J1	Send user-defined 64-byte sequence, or set to 00000000 View Path Trace J1
Pointer Movement	
Single	Single pointer justification (increment or decrement)
Burst	Bursts of two to eight pointer justifications spaced four frames apart. All adjustments within a given burst are in the same direction. Subsequent bursts are in alternating directions
Continuous	Pointer justifications occur continuously at a predetermined rate in an incrementing, decrementing, or alternating direction. Rate between movements: 2 ms to 10 s, with a resolution of 1 ms.
Set to Value	Set to a new location with or without the NDF being set. Range is 0 to 1023 (783 – 1023 are illegal locations).
Pointer Test Sequences	
Single pointer adjustment	Time between pointer adjustments: 30 s.
Alternating pointer adjustment	Alternating, single Alternate, double
Pointer adjustment burst	Time between 3 pointers is 0.5 ms, 0.5 ms Time between pointer burst: 30 s

Table D-1: Standard CTS 710 Specifications (Cont.)

Characteristic	Description
Phase transient pointer adjustment burst	Time between 7 pointers is 0.25 s, 0.25 s, 0.5 s, 0.5 s, 0.5 s, 0.5 s. Time between pointer burst: 30 s.
Periodic pointer adjustment – 87-3 pattern	– 87-3 pattern – 87-3 pattern with Cancelled pointer movement number 87 – 87-3 pattern with Added pointer after the 43rd pointer
Periodic pointer adjustment – continuous pattern	– continuous pattern – continuous pattern with cancellation of one pointer – continuous pattern with added pointer
Pointer Direction	Positive or Negative
Initialization Period	On or Off Thirty second burst of 1 pointer per second in the same direction as the selected test
Cool Down Period	On or Off This will last at least 60 seconds
Measurements	
Error Count, Error Rate, and Errored Seconds for:	B1, B2, B3, Payload, Line-FEBE, Path-FEBE
Alarm and Failure Seconds for	LOS, OOF, LOF, SPE LOP, Line AIS & FERF, Path AIS & FERF, Loss of Power, Loss of Pattern Sync
STS SPE Pointer Measurements	Seconds: Count: LOP Illegal pointers Illegal pointers Positive justifications NDF Negative justifications
T1M1.3 Analysis	
Section B1 Seconds and ratio	Error Blocks, ES, SES, UAS Background Block Errors
Line B2 & FEBE Seconds and % of total time	Error-Count, ES, ES-A, ES-B, SES, UAS, EFS FEBE-Count, FEBE-ES, FEBE-UAS, FEBE-EFS
Path B3 & FEBE Seconds and % of total time	Error-Count, ES, ES-A, ES-B, SES, UAS, EFS FEBE-Count, FEBE-ES, FEBE-UAS, FEBE-EFS

Table D-1: Standard CTS 710 Specifications (Cont.)

Characteristic	Description
Pattern Bit Seconds and % of total time	Error-Count, ES, ES-A, ES-B, SES, UAS, EFS
LEDs	
Status Indicators	LOS, LOF, LOP, Line AIS, Line FERF, Path AIS, Path FERF, Errors, Pointer Adjust, Signal Present, Pattern Lock
Histograms	
Error Count, Bit Error Rate and Errored Seconds	B1, B2, B3, Line-FEBE, Path-FEBE, Pattern Bit
Alarms & Failures On/Off	LOS, OOF, LOF, SPE-LOP, Line-AIS, Line-FERF, Path-AIS, Path-FERF, Pattern Loss, Loss of Power
Pointers	STS Pointer Value, Pointer Justification
Measurement Utilities	
Measurement Control	Manual Start/Stop Timed: 1 s to 99 days with 1 s resolution Continuous
Histogram Display Resolution	1 min, 5 min, 15 min, 1 hour (displays 72 hours with 1 min resolution) 15 min, 60 min, 4 hrs, 12 hrs (displays 45 days with 15 min resolution)
Result Logging	All measurements are recorded with start, stop time and date. The current and previous results are stored in memory both totalized and graphical. Both graphical and totalized results can be stored on a disk.
Utilities	
TroubleScan	Scans all measurement results for key violations

Table D-1: Standard CTS 710 Specifications (Cont.)

Characteristic	Description
AutoScan	AutoScan to incoming signal (rate, mapping, framing, and pattern). Identifies incoming signal and presents graphical display of SPE and VT structure. Identifies VT signal status by showing VT number, equipped vs unequipped, alarms and pattern.
Stored Setups	5 front panel setups in memory 200 front panel setups per disk
Pass/Fail Tests	Predefined Pass/Fail Tests can be created, stored and executed Pass/Fail tests are stored on disk 200 Pass/Fail test setups per disk
Add/Drop Interface for Data Communication Channels and User Channels	A DB-37 female connector provides the interface to an external protocol analyzer. Clock and data signals are differential TTL, conform to RS-422 specifications, and are also compatible with single-ended TTL signals. Add/Drop: D1–D3, D4–D12, F1, F2 Connector: 37 Pin DIN (DTE and DCE)
Triggering	Pulse at start of each frame, (Tx and Rx), Connector: 37 Pin DIN
Disk Drive	3.5 inch, 1.44 MB, DOS compatible Measurement Result stored in ASCII Stored Setups and Pass/Fail Tests in IEEE 488.2 format
Printer	Optional printer in pouch (thermal): HC 411 Printer support: Epson, HP Thinkjet Serial Printer Port: RS-232 Print to disk: BMP format, Interleaf format, and Encapsulated PostScript
Computer Interface	IEEE-488.2 interface RS-232-C interface (DB9)

Table D-1: Standard CTS 710 Specifications (Cont.)

Characteristic	Description
Help Mode	Online task-oriented help
Display	7 inch diagonal CRT, magnetic deflection Horizontal raster-scan green phosphor Resolution: 640 by 480 pixels VGA output: 15 pin connector

Table D-2: Option 22 DS1/DS3/VT1.5 Capabilities

Characteristic	Description
DS1/DS3 Generator	
Electrical Output	
Data Rates	DS1 (1.544 Mb/s) DS3 (44.736 Mb/s)
Formats	DS1: AMI, B8ZS coded DS3: B3ZS coded
Signal Level	DS1: 3 V peak ± 0.6 V into 100 Ω DS3: 0.6 V peak ± 0.24 V into 75 Ω
Pulse Shape	Meets ANSI T1-102 Pulse Masks
Connectors	DS1: Bantam 100 Ω DS3: BNC 75 Ω
Data Source	DS1: DS1 Generator SONET VT1.5 Drop DS3: DS3 Generator SONET SPE Drop
DS1/DS3 Internal Pattern Generator	
Framing	DS1: SF(D4) ESF Unframed DS3: M13 C-bit Parity Unframed
Patterns	PRBS: 2 ¹⁵ -1, 2 ²⁰ -1, 2 ²³ -1; All 1's, All 0's, Fixed Pattern 8 bit, Fixed Pattern 16 bit, Fixed Pattern 24 bit, QRSS (DS1 only), 1 in 8 (DS1 only), 3 in 24 (DS1 only)
Errors Single or Continuous	DS1: Frame Bit Error CRC-6 Error (ESF only) Pattern Bit Error DS3: Frame Bit Error P Parity Bit Error (M13 framing only) C Parity Bit Error (C-Bit parity only) Pattern Bit Error

Table D-2: Option 22 DS1/DS3/VT1.5 Capabilities (Cont.)

Characteristic	Description
Error Rate Range	1×10^{-2} to 1×10^{-8} with 0.1 resolution ¹
Alarms and Failures	DS1: Yellow AIS DS3: Yellow AIS (DS3 blue) Idle
VT1.5/DS3 Mapping	
VT1.5 Map Signal Source	Internal DS1 Generator Received DS1 signal
VT1.5 Mapping	Floating Asynch
VT1.5 Active Map Channel Selection	Allows selection of any one of 28 VT channels Remaining 27 VT channels are background
VT1.5 Background Channels	
Background Channel Content	When internal DS1 generator is used: QRSS or Idle pattern (11010101) When external source is used: QRSS
Background Channel Framing	When internal DS1 generator is used: Same as active channel When external source is used: Unframed
VT1.5 Errors (Signal or Continuous)	VT BIP-2 VT FEBE
VT1.5 Alarms and Failures	VT AIS VT FERF VT Loss of Pointer VT Loss of Multiframe
DS3 SPE Add Source	Internal DS3 Generator Received DS3 signal
Transmitter Clock	
Internal Clock	
Accuracy	± 4.6 ppm, for instrument calibrated within 24 months

¹ Depends on error type.

Table D-2: Option 22 DS1/DS3/VT1.5 Capabilities (Cont.)

Characteristic	Description
External Clock Reference	
Rates	1.544 MHz \pm 40 ppm
Input	Balanced, 100 Ω \pm 5%, DS1 Bantam connector
Recovered Clock	
Loop timing	Clock is recovered from received signal
Transmit Line Frequency Offset	
Frequency offset rate	\pm 100 ppm of nominal line rate with 0.1 ppm resolution
External DS1/DS3	Clock Input (for Jitter Generation)
Rates	1.544 Mb/s, 44.736 Mb/s
Input	Unbalanced, 75 Ω BNC, AC coupled
Signal Level	0.5 volts to 1.5 volts peak to peak
DS1/DS3 Receiver	
Electrical Input	
Data Rates	DS1: (1.544 MHz) \pm 150 ppm DS3: (44.736 MHz) \pm 150 ppm
Formats	DS1: AMI, B8ZS DS3: B3ZS
Impedance	DS1: 100 Ω balanced DS1 Bridged: 1 k Ω balanced DS3: 75 Ω to ground, unbalanced
Signal Level	DSX-1: 3 Vpk \pm 0.6 V into 100 Ω DS-1 Monitor: 20 dB flat loss below DSX-1 DSX-3: 0.6 Vpk \pm 0.24 V into 75 Ω DS-3 Monitor: 20 dB flat loss below DSX-3
Connectors	DS1: Bantam 100 Ω DS3: BNC 75 Ω

Table D-2: Option 22 DS1/DS3/VT1.5 Capabilities (Cont.)

Characteristic	Description
DS1/DS3 Internal Pattern Receiver	
Pattern Receiver Source	DS1: Rx Signal (ext) VT1.5 Drop DS3: Rx Signal (ext) SONET SPE Drop
Framing	DS1: SF(D4) ESF Unframed DS3: M13 C-bit Parity Unframed
Demultiplexing	
Demux DS3 to DS1	Allows selection of any one of 28 DS1 channels from a DS3
VT1.5/DS3 Demapping	
VT1.5 Demapping	Floating Async
VT1.5 Active Demap Channel Selection	Allows selection of any one of 28 VT channels
Drop VT1.5 to	Internal DS1 Receiver External DS1 signal output
Drop DS3 from	Selected STS-1 Channel
Drop DS3 to	Internal DS3 Receiver External DS3 signal output
VT Path Overhead	
VT1.5 Path Overhead Access	V5 control (---xxx-) Set VT Path Overhead bytes to any value from binary 00000000 to 11111111: Z3, Z4, and Z5 View all Path Overhead bytes
VT1.5 Path Trace Byte J2	Send user-defined 16-byte sequence, or set to 00000000 View Path Trace J2

Table D-2: Option 22 DS1/DS3/VT1.5 Capabilities (Cont.)

Characteristic	Description
VT Pointer Movement	
VT1.5 Pointer Interaction	VT1.5 or STS, but not both at the same time
Single	Single pointer justification (increment or decrement)
Burst	Bursts of two to eight pointer justifications spaced four multi-frames apart. All adjustments within a given burst are in the same direction. Subsequent bursts are in alternating directions
Continuous	Pointer justifications occur continuously at a predetermined rate in an incrementing, decrementing, or alternating direction. Rate between movements: 48 ms to 1 s, with a resolution of 1 ms
Set to Value	Set to a new location with or without the NDF being set. Range is from 0 to 1023 (104 – 1023 are illegal locations).
VT Pointer Test Sequences	
Single pointer adjustment	Time between pointer adjustments: 30 s
Alternating pointer adjustment	Single Double
Pointer adjustment burst	Time between 3 pointers is 2 ms, 2 ms Time between pointer burst: 30 s
Phase transient pointer adjustment burst	Time between 7 pointers is 0.25 s, 0.25 s, 0.5 s, 0.5 s, 0.5 s, 0.5 s Time between pointer burst: 30 s
Periodic pointer adjustment test sequence – 26-1 pattern	– 26-1 pattern – 26-1 pattern with Cancelled pointer movement number 26 – 26-1 pattern with Added pointer after the 13th pointer

Table D-2: Option 22 DS1/DS3/VT1.5 Capabilities (Cont.)

Characteristic	Description
Periodic pointer adjustment – continuous pattern	– continuous pattern – continuous pattern with cancellation of one pointer – continuous pattern with added pointer
Pointer Direction	Positive or Negative
Initialization Period	On or Off Thirty second burst of 1 pointer per second in the same direction as the selected test.
Cool Down Period	On or Off This will last at least 60 seconds.
Measurements	
DS1 Error Count, Error Rate and Error seconds for	Frame Bit CRC-6 (ESF only) Pattern Bit
DS3 Error Count, Error Rate and Error seconds for	Frame Bit P Parity Bit (M13 framing only) C Parity Bit (C-Bit parity only) Pattern Bit
VT1.5 Error Count, Error Rate and Error seconds for	VT BIP-2 VT FEBE
DS1 Alarm and Failure Seconds for	AIS Yellow Loss of Pattern Sync Loss of Frame Loss of Signal
DS3 Alarm and Failure Seconds for	AIS (DS3 Blue) Yellow (DS3 FERF) Idle Loss of Pattern Sync Loss of Frame Loss of Signal
VT1.5 Alarm and Failure Seconds for	VT AIS VT FERF VT Loss of Pointer VT Loss of Multiframe

Table D-2: Option 22 DS1/DS3/VT1.5 Capabilities (Cont.)

Characteristic	Description
VT1.5 Pointer Measurements	Seconds: Count: LOP Illegal pointers Illegal pointers Positive justifications NDF Negative justifications
T1M1.3 Analysis	
VT1.5 BIP-2 & FEBE Seconds and % of total time	Error-Count, ES, ES-A, ES-B, SES UAS, EFS, FEBE-Count, FEBE-ES, FEBE-UAS, FEBE-EFS
DS1 Frame Error (SF) & CRC-6 Error (ESF), Seconds and % of total time	Error-Count, ES, ES-A, ES-B, SES, UAS, EFS
DS3 P-Bit Error (M13) & C-Parity Error (C-Bit Parity), Seconds and % of total time	Error-Count, ES, ES-A, ES-B, SES, UAS, EFS
DS1/DS3 Payload (Pattern Bit Errors), Seconds and % of total time	Error-Count, ES, ES-A, ES-B, SES,UAS, EFS
LEDs	
Status Indicators	VT AIS DS1/DS3 AIS VT FERF DS1/DS3 YELLOW VT BIP-2 ERROR DS1/DS3 ERROR
Histograms for DS1, DS3 and VT1.5	
DS1/DS3/VT1.5 Error Count, Bit Error Rate and Errored Seconds	CRC, Frame, Parity, VT-BIT2, VT-FEBE, Pattern Bit
DS1/DS3/VT1.5 Alarms & Failures On/Off	LOS, LOF, AIS, Yellow (FERF), VT-LOP, VT-AIS, VT-FERF, VT-LOM, Pattern Loss, Loss of Power
VT1.5 Pointers	VT Pointer Value, Pointer Justification
Measurement Utilities	
Measurement Control	Manual Start/Stop Timed: 1 s to 99 days with 1 s resolution Continuous

Table D-2: Option 22 DS1/DS3/VT1.5 Capabilities (Cont.)

Characteristic	Description
Histogram Display Resolution	1 min, 5 min, 15 min, 1 hour (displays 72 hours with 1 min resolution) 15 min, 60 min, 4 hrs, 12 hrs (displays 45 days with 15 min resolution)
Result Logging	All measurements are recorded with start, stop time and date. The current and previous results are stored in memory both totalized and graphical. Both graphical and totalized results can be stored on a disk.

Table D-3: Environmental Specifications

Characteristic	Description
Environmental	
Temperature	Operating: 0° C to +50° C Nonoperating: -40° C to +75° C
Altitude	Operating: 4,572 m (15,000 ft) Nonoperating: 12,192 m (40,000 ft)
Humidity	Operating: To 95%, relative humidity at or below +45° C for 2 hours or less To 90% relative humidity at or below 30° C, continuous
Transportation Handling	Qualifies under National Safe Transit Association 1s Pre-shipment Test; 1A-B-1.

Table D-4: Physical Characteristics

Characteristic	Description
Dimensions	Height: 165 mm (6.5 in) 191 mm (7.5 in) with accessory pouch Width: 362 mm (14.25 in) Depth: 490 mm (19.25 in) with front cover 564 mm (22.2 in) with handle extended
Weight	Net: Approximately 8.7 kg (19.3 lb) Shipping: Approximately 14.1 kg (31 lb)
Power Requirements	Line Voltage Range: 90 to 250 V _{RMS} Line Frequency: 48 to 62 Hz. Power Consumption: 240 Watts max.

Table D-5: Certifications and compliances

Characteristic	Description
EC Declaration of Conformity – EMC	Meets intent of Directive 89/336/EEC for Electromagnetic Compatibility. Compliance was demonstrated to the following specifications as listed in the Official Journal of the European Communities: EN 55011 Class A Radiated and Conducted Emissions EN 50082-1 Immunity: IEC 801-2 Electrostatic Discharge Immunity IEC 801-3 RF Electromagnetic Field Immunity IEC 801-4 Electrical Fast Transient/Burst Immunity IEC 801-5 Power Line Surge Immunity
FCC Compliance	Emissions comply with FCC Code of Federal Regulations 47, Part 15, Subpart B, Class A Limits

Table D-5: Certifications and compliances (cont.)

Characteristic	Description
EC Declaration of Conformity – Low Voltage	<p>Compliance was demonstrated to the following specification as listed in the Official Journal of the European Communities:</p> <p>Low Voltage Directive 73/23/EEC</p> <p>EN 61010-1/A1 Safety requirements for electrical equipment for measurement, control, and laboratory use</p>
Approvals	<p>UL1244 – Electrical and Electronic Measuring and Testing Equipment</p> <p>CAN/CSA-22.2 No. 231 – CSA Safety requirements for Electrical and Electronic Measuring and testing Equipment</p>
Conditions for Safety Certification	<p>Operating temperature: +5 to +40 °C</p> <p>Max. Operating altitude: 2000 m</p> <p>Equipment Type: Test and measuring</p> <p>Safety Class: Class I, grounded product (IEC1010-1)</p> <p>Overtoltage Category: CAT II (IEC1010-1)</p> <p>Polution Degree: Polution Degree 2, rated for indoor use only (IEC1010-1)</p>

Table D-5: Certifications and compliances (cont.)

Characteristic	Description
Installation Category Descriptions	<p>Terminals on this product may have different installation category designations. The installation categories are:</p> <p>CAT III Distribution-level mains (usually permanently connected). Equipment at this level is typically in a fixed industrial location</p> <p>CAT II Local-level mains (wall sockets). Equipment at this level includes appliances, portable tools, and similar products. Equipment is usually cord-connected</p> <p>CAT I Secondary (signal level) or battery operated circuits of electronic equipment</p>

Appendix E: Incoming Inspection Test

The purpose of the incoming inspection test is to verify that the CTS 710 SONET Test Set is functioning properly. The incoming inspection test relies on the front panel status lights to indicate the results of the test. Figure E-1 shows the location of the status lights used in these procedures.

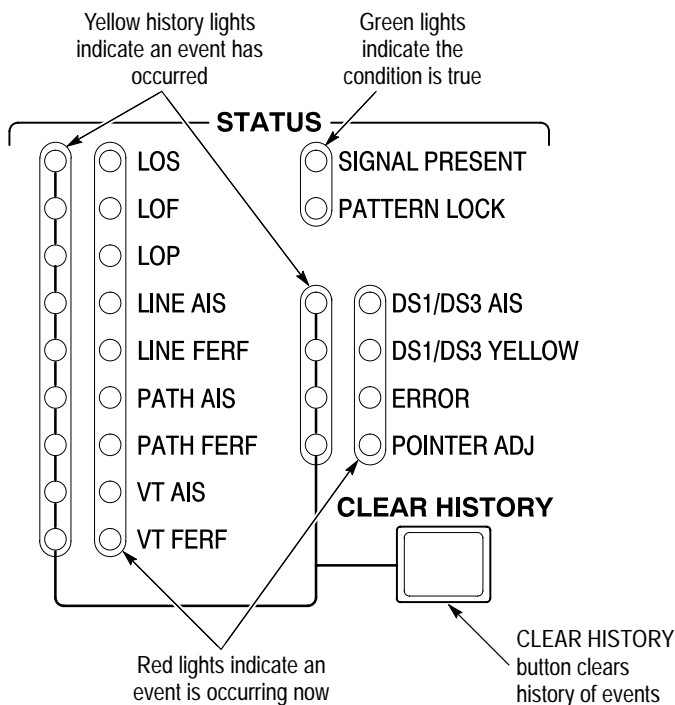

Figure E-1: Front-Panel Status Lights

Table E-1 details the equipment required to complete the incoming inspection test.

Table E-1: Required Equipment

Item Number and Description	Minimum Requirements	Example	Purpose	
1	Optical Fiber Cable ¹	62.5/125 μm multimode fiber; FC/PC connector on one end; compatible with CTS 710 connector option on other end	FC/PC to FC/PC, Tektronix part number 174-2322-00	Interconnect optical signals
2	75 Ω Coaxial Cable	75 Ω impedance; \approx 1 m length, BNC connectors	Tektronix part number 012-1338-00	Interconnect electrical signals
3	110 Ω Bantam Cable	110 Ω impedance; \approx 6 ft length, bantam connectors	Tektronix part number 012-1314-00	Interconnect electrical signals

¹ This equipment is required to test a CTS 710 with any one of the optional Optical/Electrical Plug-in Interface Modules installed; otherwise, it is not required.

Loop-Back Connection

The incoming inspection test requires an external loop-back connection from the TRANSMIT/OUT output to the RECEIVE/IN input. For the SONET rate electrical loop-back, you can use the 75 Ω BNC coaxial cable provided as a standard accessory to the CTS 710. If the Add/Drop/Test Option is installed, you can use the 75 Ω coaxial cable for checking DS3 operation, and will need to use a bantam cable (a standard accessory with the Add/Drop/Test Option) to check DS1 operation. If one of the Electrical/Optical Plug-in Interface Modules is installed in your CTS 710, you also need a short optical cable that is compatible with the optical connectors on your instrument. Optical cables are not included as standard accessories to the CTS 710.

How to Proceed

If the CTS 710 fails any of these tests, it has failed the incoming inspection test. Double check the electrical and optical connections and repeat any failed test. If the failure persists, contact your local Tektronix field office or representative for assistance.

You can perform the following tests in any order. Each test is independent and does not depend on the setup from the previous test.

- Turn on the CTS 710. Allow it to warm up for 20 minutes before proceeding with the tests.

System Self Test with External Loop-Back

This test executes the Self Test including coverage of the transmitter and receiver I/O circuitry.

Equipment Required	75 Ω BNC coaxial cable for electrical loop-back Optical loop-back cable if Electrical/Optical Plug-in Interface Module is installed
Prerequisites	CTS 710 warmed-up at least twenty minutes
Time Required	Approximately two minutes

1. Attach electrical and optical loop-back cables from the TRANSMIT/OUT outputs to the RECEIVE/IN inputs.

NOTE. Connectors labeled *OUT* and *IN* are present only on instruments equipped with the *Add/Drop/Test Option*.

2. Set up and execute the system self test with the following sequence:

Press Menu Button	Select Menu Page	Highlight Parameter	Select Choice
UTILITY	SELF TEST	Self Test Group	Sys: Ext
		Self Test Control	Run

SONET Signals

This test checks that the CTS 710 transmits and receives error-free signals at all SONET rates.

Equipment Required	75 Ω BNC coaxial cable for electrical loop-back Optical loop-back cable if Electrical/Optical Plug-in Interface Module is installed
Prerequisites	CTS 710 warmed up at least twenty minutes
Time Required	Approximately five minutes

1. Attach electrical and optical loop-back cables from the TRANSMIT outputs to the RECEIVE inputs.

2. Perform the initial setup of the CTS 710 with the following sequence:

Press Menu Button	Select Menu Page	Highlight Parameter	Select Choice
TEST SETUPS	RECALL INSTRUMENT SETUPS	DEFAULT FACTORY SETTINGS	Recall Setup
TRANSMIT	TRANSMIT SETTINGS	Tx/Rx Settings	Coupled
	POINTERS & TIMING	Pointer Control	Set Value
		Pointer Value set to	Default 522

3. To check the STS-1 rate, press the **CLEAR HISTORY** button, wait two seconds, and then verify that no yellow history lights are on.
4. To check the STS-3 rate, set the transmit rate as follows:

Press Menu Button	Select Menu Page	Highlight Parameter	Select Choice
TRANSMIT	TRANSMIT SETTINGS	Transmit Rate	STS-3

NOTE. When changing the transmit rate, the LOP, LOS, and LOF history lights may turn on; this is normal. However, the red event lights should not stay on.

5. Press the **CLEAR HISTORY** button, wait two seconds, and then verify that no yellow history lights are on.
6. Steps 7 through 10 of this procedure apply only if one of the Electrical/Optical Plug-in Interface Modules (Option 03 or Option 04) is installed in your CTS 710.

7. To check the OC-3 rate, perform the setup sequence:

Press Menu Button	Select Menu Page	Highlight Parameter	Select Choice
TRANSMIT	TRANSMIT SETTINGS	Transmit Rate	OC-3

8. Press the **CLEAR HISTORY** button, wait two seconds, and then verify that no yellow history lights are on.
9. If your CTS 710 does not have OC-12 capability, you have completed the incoming inspection test. To check the OC-12 rate, perform the setup sequence:

Press Menu Button	Select Menu Page	Highlight Parameter	Select Choice
TRANSMIT	TRANSMIT SETTINGS	Transmit Rate	OC-12

10. Press the **CLEAR HISTORY** button, wait two seconds, and then verify that no yellow history lights are on.

Tributary Signals (Add/Drop/Test Option Only)

This test checks that the CTS 710 transmits and receives error-free signals at all tributary rates.

Equipment Required	75 Ω BNC coaxial cable for DS3 electrical loop-back 110 Ω Bantam Cable for DS1 electrical loop-back
Prerequisites	CTS 710 warmed up at least twenty minutes
Time Required	Approximately five minutes

1. Attach electrical and optical loop-back cables from the OUT outputs to the IN inputs.
2. Perform the initial setup of the CTS 710 with the following sequence:

Press Menu Button	Select Menu Page	Highlight Parameter	Select Choice
TEST SETUPS	RECALL INSTRUMENT SETUPS	DEFAULT FACTORY SETTINGS	Recall Setup
TRANSMIT	TRANSMIT SETTINGS	Tx/Rx Settings	Coupled
		Transmit Rate	DS1

3. To check the DS1 rate, press the **CLEAR HISTORY** button, wait two seconds, and then verify that no yellow history lights are on.
4. To check the DS3 rate, set the transmit rate as follows:

Press Menu Button	Select Menu Page	Highlight Parameter	Select Choice
TRANSMIT	TRANSMIT SETTINGS	Transmit Rate	DS3

NOTE. When changing the transmit rate, the LOP, LOS, and LOF history lights may turn on; this is normal. However, the red error lights should not stay on.

5. Press the **CLEAR HISTORY** button, wait two seconds, and then verify that no yellow history lights are on.

This completes the incoming inspection test.

Appendix F: Example Disk Contents

This manual ships with a disk containing files that you can load into your CTS 710. The files are examples of instrument setups, test results and pass/fail tests. The files contained on the disk are described in the following paragraphs.

Instrument Setups

The STRESS file is an instrument setup file. The file sets up the CTS 710 to generate an STS-1 signal that contains alarms, errors and pointer movements. The STRESS file is an example of how the CTS 710 can save you time by storing instrument setups on disk for later recall.

Test Results

The ONEDAY file is a test results file. It contains one day (24 hours) of test results. Recall the file from the RECALL RESULTS page of the RESULTS menu. You can view the test results on the MAIN RESULTS and ERROR ANALYSIS pages of the RESULTS menu. You can view a graph of the test results on the HISTORY GRAPHS page of the RESULTS menu. The HISTORY GRAPHS page shows when alarms, errors and pointer movements occurred.

Pass/Fail Tests

The DEMO_10S file is a pass/fail test that runs for just 10 seconds. To make the test fail, press the INSERT ERROR button on the front panel. To run the test, connect an electrical cable between the TRANSMIT and RECEIVE connectors on the front panel and then recall the test from the RECALL PASS/FAIL TESTS page of the TEST SETUPS menu. You can see how the test was set up by viewing the test parameters on the SAVE PASS/FAIL TESTS page of the TEST SETUPS menu after you recall the test.

The BER_STS1 file is a 15-minute BER test. The test passes if the BER is better than $10E-7$. To run the test, connect an electrical cable between the TRANSMIT and RECEIVE connectors on the front panel and then recall the test from the RECALL PASS/FAIL TESTS page of the TEST SETUPS menu. You can see how the test was set up by viewing the test parameters on the SAVE PASS/FAIL TESTS page of the TEST SETUPS menu after you recall the test.

Appendix G: Rear-Panel Connectors

This appendix describes the connectors located on the rear panel of the CTS 710.

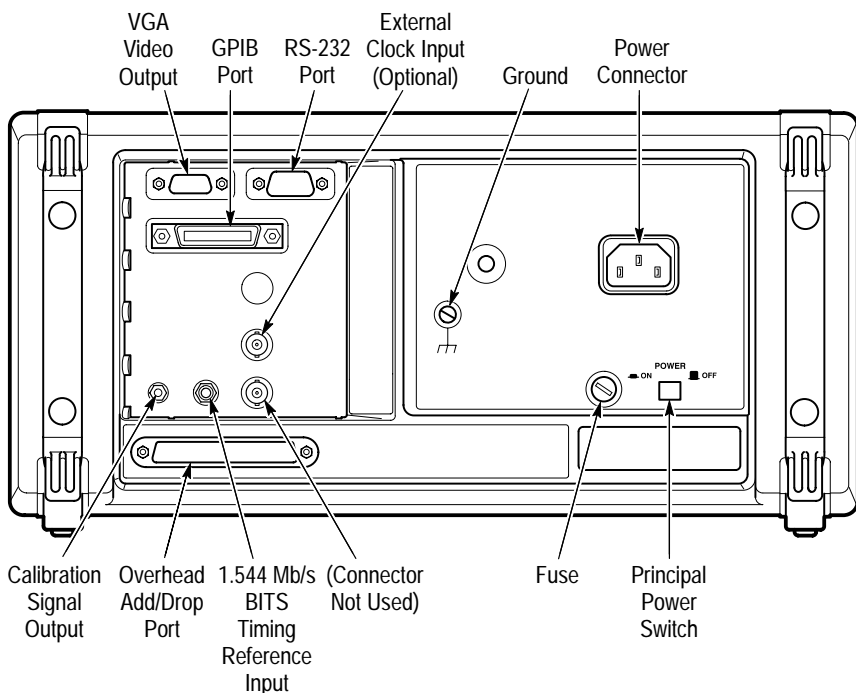

Figure G-1: CTS 710 Rear Panel Connectors

VGA Video Output

The CTS 710 can drive an external IBM-compatible VGA monitor. There are no parameters to set in order to drive an external monitor. The output is monochrome (green only); the resolution is 640 pixels × 480 pixels. Figure G-2 shows how the pins are numbered on the

VGA connector. Table G–1 lists the pin assignment for the rear-panel VGA connector.

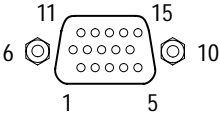

Figure G–2: The VGA Video Output Connector

Table G–1: VGA Video Output Connector Pin Assignment

Pin Number	Description
1	Ground
2	Video Signal (Green)
3	Ground
4	–
5	–
6	Ground
7	Ground
8	Ground
9	–
10	Ground
11	Ground
12	–
13	Horizontal Sync
14	Vertical Sync
15	–

GPIB Port

The GPIB (General Purpose Interface Bus) port is used for remote control of the CTS 710. For detailed information on remote control of the CTS 710, see the *CTS 710 SONET Test Set Programmer Manual* (Tektronix part number 070-8924-XX)

RS-232 Port

The rear panel RS-232 connector is used to connect to printers and instrument controllers. Set the RS-232 parameters for printers on the **PRINTER SETUP** page of the **UTILITY** menu. Set the RS-232 parameters for instrument controllers on the **REMOTE CONTROL** page of the **UTILITY** menu. You can find more detailed information on remote control of the CTS 710 in the *CTS 710 SONET Test Set Programmer Manual*. Figure G-3 shows how the pins are numbered on the RS-232 port. Table G-2 lists the pin assignment for the RS-232 port on the CTS 710 rear panel.

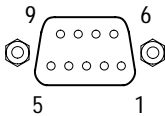

Figure G-3: The RS-232 Port

Table G-2: RS-232 Rear Panel Connector Pin Assignment

Pin Number	Name	Description
1	DCD	Data Carrier Detect
2	RxD	Receive Data
3	TxD	Transmit Data
4	DTR	Data Terminal Ready
5	GND	Signal Ground

Table G-2: RS-232 Rear Panel Connector Pin Assignment (Cont.)

Pin Number	Name	Description
6	DSR	Data Set Ready
7	RTS	Request To Send
8	CTS	Clear To Send
9	RI	Ring Indicator

External Clock Input

You use the external clock input to provide an external reference for the transmit clock. To set the transmit clock to an external clock:

Press Menu Button	Select Menu Page	Highlight Parameter	Select Choice
TRANSMIT	TRANSMIT SETTINGS	Transmit Clock	External BITS
			External DS _n

- Select **External** to use an external BITS reference clock for SONET or DS_n signals.
- Select **External DS_n** to use an external clock for DS1/DS3 signals. This selection enables you to input a jittered clock to provide DS_n line jitter.

Calibration Signal Output

You use the calibration signal output for servicing the CTS 710. Information on servicing the CTS 710 is located in the *CTS 710 SONET Test Set & CTS 750 SDH Test Set Service Manual*, Tektronix part number 070-8853-XX.

Overhead Add/Drop Port

You use the Overhead Add/Drop port to add/drop the section and line data communication channels (DCC), and the section and line user channels. The DCC and user channel add/drop functions are independent; for example, you can add a DCC while dropping a user channel. Only one DCC or user channel can be added or dropped at a time. The parameters for adding a DCC or a user channel are located on the TRANSPORT OVERHEAD and PATH OVERHEAD pages of the TRANSMIT menu. The parameters for dropping a DCC or a user channel are located on the TRANSPORT OVERHEAD and PATH OVERHEAD pages of the RECEIVE menu.

The Overhead Add/Drop port uses a gapped clock. Figure G-4 shows how the pins are numbered on the Overhead Add/Drop port. Tables G-3 and G-4 summarize the different communication channels.

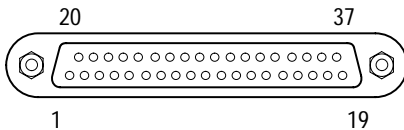

Figure G-4: The Overhead Add/Drop Port

Table G-3: Overhead Channels Added

Added Channel	Bytes Added	Data Rate	Clock Rate
Section DCC	D1, D2, D3	192 kbps	216 kHz
Line DCC	D4, D5, D6, D7, D8, D9, D10, D11, D12	576 kbps	2.16 MHz ¹
Section User Channel	F1	64 kbps	72 kHz
Path User Channel	F2	64 kbps	72 kHz

¹ The Line DCC signal has a 1/3–2/3 duty ratio.

Table G-4: Overhead Channels Dropped

Dropped Channel	Bytes Dropped	Data Rate	Clock Rate
Section DCC	D1, D2, D3	192 kbps	216 kHz
Line DCC	D4, D5, D6, D7, D8, D9, D10, D11, D12	576 kbps	2.16 MHz
Section User Channel	F1	64 kbps	72 kHz
Path User Channel	F2	64 kbps	72 kHz

Table G-5 summarizes the data signal pin assignments on the Overhead Add/Drop port. Table G-6 summarizes the additional pin assignments on the Overhead Add/Drop port. The signal lines listed in Table G-5 can drive 100 Ω , differential TTL lines. The signal lines are terminated with a 100 Ω impedance and can drive 100 Ω lines.

Table G-5: Overhead Add/Drop Port Data Signal Pin Assignments

Signal	+Pin	-Pin
Added Tx Data (input)	4	22
Added Tx Clock (output)	5	23
Tx Common (ground)	37	-
Dropped Rx Data (output)	6	24
Dropped Rx Clock (output)	8	26
Rx Common (ground)	20	-

Table G-6: Overhead Add/Drop Port Additional Pin Assignments

Signal	Pin
Shield (ground)	1
Signal Ground (ground)	19
Reserved	33
Tx Frame Pulse (output) ¹	15
Rx Frame Pulse (output) ¹	36

¹ The Frame Pulse signals are nominal 8 kHz, TTL, single-ended signals.

BITS Timing Reference Input

Use the BITS (Building Integrated Timing Supply) timing reference input connector to connect to a BITS reference. To synchronize the CTS 710 transmit clock with a BITS reference:

Press Menu Button	Select Menu Page	Highlight Parameter	Select Choice
TRANSMIT	TRANSMIT SETTINGS	Transmit Clock	BITS

Appendix H: Changing Optical Port Connectors

The following procedures are discussed in this appendix:

- Cleaning the Optical Ports
- Changing the Optical Port Connectors

Cleaning the Optical Ports

If the CTS 710 performance appears degraded, the optical fiber and optical port may be dirty. Clean the fiber connector with a clean cloth.

To clean an optical port:

1. Verify that the CTS 710 has been turned off with the principal power switch on the rear panel.
2. Remove the four screws that attach the bulkhead connector to the front panel (see Figure H-1).
3. Gently pull the bulkhead out of the unit and unscrew the fiber connector. Be careful not to pull beyond the fiber slack.
4. Using a soft, lint-free cloth with a high-quality glass cleaner, clean the tip of the fiber cable.
5. If available, use low-pressure compressed air or canned air to blow any dirt out of the bulkhead connector. If compressed air is not available, then the bulkhead will have to be taken apart and cleaned. Refer to the *Changing the Optical Port Connectors* procedure, on page H-2, for information about bulkhead disassembly.
6. After cleaning the bulkhead, reconnect the fiber and install the bulkhead. Be sure to reinstall the dustcap chain.

NOTE. To keep cleaning to a minimum, install the dustcap when no fiber is connected to the optical port.

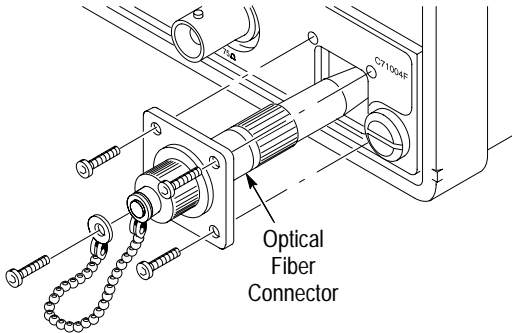

Figure H-1: Removing the Optical Bulkhead Connector

Changing the Optical Port Connectors

The CTS 710 is shipped with the FC connector bulkhead and dustcap installed. If you wish to change to the ST, DIN 47256, or SC connectors perform the following procedure:

1. Verify that the CTS 710 has been turned off with the principal power switch on the rear panel.
2. Remove the four screws that attach the bulkhead connector to the front panel (see Figure H-1).
3. Gently pull the bulkhead out of the unit and unscrew the fiber connector. Be careful not to pull beyond the fiber slack.
4. Disassemble the bulkhead as shown in Figures H-2 through H-5.

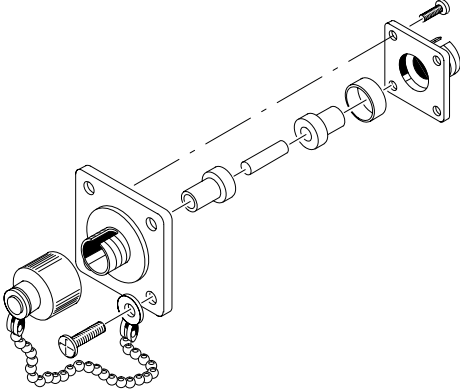

Figure H-2: FC Optical Bulkhead Assembly

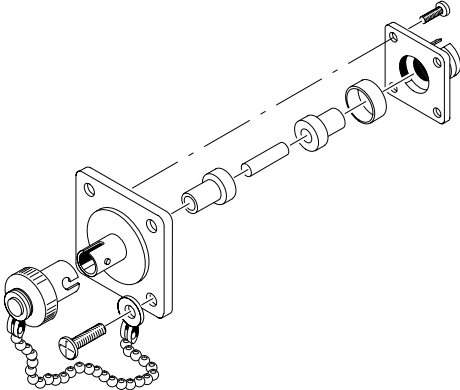

Figure H-3: ST Optical Bulkhead Assembly

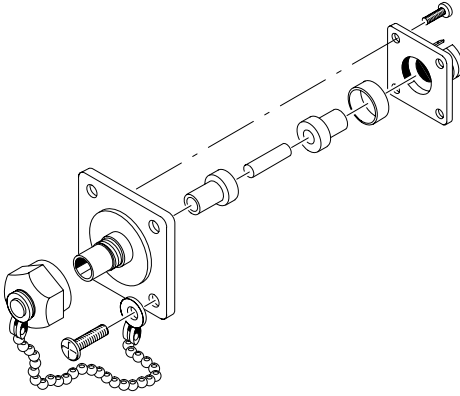

Figure H-4: DIN 47256 Optical Bulkhead Assembly

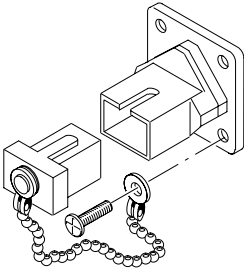

Figure H-5: SC Optical Bulkhead Assembly

5. Replace the current bulkhead with the one you wish to use and reassemble.
6. Installation is the reverse of steps 1 through 3.

Appendix I: Packing for Shipment

If you ship the CTS 710, pack it in the original shipping carton and packing material. If the original packing material is not available, package the instrument as follows:

1. Obtain a corrugated cardboard shipping carton with inside dimensions at least 15 cm (6 in) taller, wider, and deeper than the CTS 710. The shipping carton must be constructed of cardboard with 170 kg (375 lb) test strength.
2. If you are shipping the CTS 710 to a Tektronix field office for repair, attach a tag to the CTS 710 showing the instrument owner and address, the name of the person to contact about the instrument, the instrument type, and the serial number.
3. Wrap the CTS 710 with polyethylene sheeting or equivalent material to protect the finish.
4. Cushion the CTS 710 in the shipping carton by tightly packing dunnage or urethane foam on all sides between the carton and the CTS 710. Allow 7.5 cm (3 in) on all sides, top, and bottom.
5. Seal the shipping carton with shipping tape or an industrial stapler.



Glossary and Index

Glossary

AIS

An acronym for Alarm Indication Signal. An AIS is used to alert downstream equipment that an upstream failure has been detected.

APS

An acronym for Automatic Protection Switching.

ASCII

An acronym for American Standard Code for Information Interchange.

BER

An acronym for Bit Error Ratio (or Rate). The principal measure of quality of a digital transmission system. BER is defined as:

$$BER = \frac{\text{Number of Errors}}{\text{Total Number of Bits}}$$

BER is usually expressed as a negative exponent. For example, a BER of 10^{-7} means that 1 bit out of 10^7 bits is in error.

BIP

An acronym for Bit Interleaved Parity. A method used to monitor errors in the transmitted signal.

Bit Error

An incorrect bit. Also known as a coding violation.

BITS

An acronym for Building Integrated Timing Supply.

COFA

An acronym for Change of Frame Alignment.

CV

An acronym for Coding Violation.

dB

The symbol for decibels.

dBm

The symbol for power level in decibels relative to 1 mW.

DM

An acronym for Degraded Minute. A minute with a BER greater than 10^{-6} .

DSn

An acronym for Digital Signal-n (DS1, DS2, DS3, and DS4). DS1 is the basic multiplex rate in North America; additional rates are DS2, DS3, and DS4. The following table lists the DS_n rates and their multiple of DS1:

Digital Signal Transmission Rates

Level	Rate	Multiple of DS1
DS1	1.544 Mb/s	1
DS1c	3.152 Mb/s	2
DS2	6.312 Mb/s	4
DS3	44.736 Mb/s	24

EFS

An acronym for Error Free Seconds.

ES

An acronym for Errored Second. A second with at least one error.

FEBE

An acronym for Far End Block Error. An indication returned to the transmitting LTE that an errored block has been detected at the receiving LTE.

FERF

An acronym for Far End Receive Failure. A FERF indicates to the transmitting LTE that the receiving LTE has detected an incoming line failure or is receiving a Line AIS.

ITU

An acronym for the International Telecommunication Union.

Line

The portion of a transmission line between two multiplexers.

Line Alarm Indication Signal (AIS)

A Line AIS is generated by Section Terminating Equipment upon Loss of Signal or Loss of Frame.

Line Coding Violation (CV)

The sum of the BIP errors detected at the Line layer. Line CVs are collected using the BIP codes in the B2 bytes of the Line Overhead.

Line Errored Second (ES)

A second during which at least one Line CV occurred, or a second during which the line was in the Line AIS state.

Line Far End Receive Failure (FERF)

An indication returned to a transmitting LTE from the receiving LTE that a Line AIS or incoming line failure has been detected.

Line Overhead (LOH)

Controls the payload information using the section layer and provides alarm indications, error monitoring, and message signalling between two LTEs.

Line Severely Errored Second (SES)

A second with N or more Line CVs, or a second during which the line was in the Line AIS state. The value of N varies with the transmit rate, but corresponds to a 2×10^{-7} BER.

LOF

An acronym for Loss of Frame.

LOP

An acronym for Loss of Pointer.

LOS

An acronym for Loss of Signal.

LTE

An acronym for Line Terminating Equipment.

Mapping

The process of placing a tributary signal into a SONET SPE.

Mb/s

Megabits per second.

NE

An acronym for Network Element.

OC

An acronym for Optical Carrier.

OOF

An acronym for Out of Frame.

Optical Carrier Level N (OC-N)

An optical version of an STS-N signal.

Path

The portion of a transmission network between two terminal multiplexers.

Path Overhead (POH)

A set of bytes allocated within the information payload to carry

status and maintenance information between two network elements.

POH

An acronym for Path Overhead.

PTE

An acronym for Path Terminating Equipment.

Rx

An abbreviation for Receive.

Section

The portion of a transmission line between a Network Element (NE) and a Line Terminating Equipment (LTE) or two LTEs.

Section Coding Violation (CV)

A BIP error that is detected at the Section layer. CVs for the Section layer are collected using the BIP-8 in the B1 byte located in the Section overhead of STS-1 number 1.

Section Errored Second (ES)

A second during which at least one Section CV or OOF/COFA event occurred, or a second during which the NE was (at any point during the second) in the LOS state.

Section Overhead (SOH)

A set of bytes allocated within each frame to carry framing and error monitoring information between an NE and LTE or between two LTEs. Part of the transport overhead.

SES

An acronym for Severely Errored Seconds.

Severely Errored Seconds (SES)

A second with more than N CVs. N varies with the transmit rate but corresponds to a BER of 2×10^{-7} .

SOH

An acronym for Section Overhead.

SONET

An acronym for Synchronous Optical NETWORK.

SPE

An acronym for Synchronous Payload Envelope.

STE

An acronym for Section Terminating Equipment.

STS

An acronym for Synchronous Transport Signal.

STS-N

An acronym for Synchronous Transport Signal level-N (STS-1, -3, -9, -12, -18, -24, -36, -48). The different STS-N rates (and their optical equivalents) for the SONET Signal Hierarchy are listed in the following table:

SONET Signal Hierarchy

Electrical Signal	Optical Signal	Data Rate (Mb/s)
STS-1	OC-1	51.84
STS-3	OC-3	155.52
STS-9	OC-9	466.56
STS-12	OC-12	622.08
STS-18	OC-18	933.12
STS-24	OC-24	1244.16
STS-36	OC-36	1866.24
STS-48	OC-48	2488.32

TE

An acronym for Terminal Equipment.

Through Mode

The ability to retransmit the incoming signal and manipulate its contents.

TOH

An acronym for Transport Overhead.

Transport Overhead (TOH)

A set of bytes allocated within each frame to carry operation, administration, and maintenance information from one end of the system to the other.

Tributary

The lower rate signal that is input to a multiplexer for combination (multiplexing) with other low rate signals to form a higher rate signal.

Tx

An abbreviation for Transmit.

VT

An acronym for Virtual Tributary. A structure (not a signal) designed for transport and switching of sub-STs payloads. The sizes of VT currently in use are VT1.5, VT2, VT3, and VT6.

Yellow Signal

A code sent upstream to indicate that a failure condition has been declared downstream.

Index

A

- Abort
 - PRINT CONTROL dialog box, 3-197, 3-198
 - Self Test Control, 3-211
- accessories
 - optional, 1-2
 - standard, 1-2
- accessory pouch, installing, 1-3
- Added Tx Clock, Overhead Add/Drop Port, G-6
- Added Tx Data, Overhead Add/Drop Port, G-6
- adding a tributary signal, 3-72
- adjusting pointers, 3-141
- AIS, APS COMMANDS, 3-170
- Alarm, Fail If condition, 3-39
- alarm, audible. *See* beeper
- Alarms, MAIN RESULTS, 3-175, 3-177
- Alternate, Pointer Direction, 3-148
- AMI, Transmit Line Code, 3-94
- Analyze VT, AUTOSCAN dialog box, 3-57
- APS Mode, APS COMMANDS, 3-161
- APS response, checking, 3-161
- Architecture, APS COMMANDS, 3-169
- AUTOSCAN button, 3-55

B

- B3ZS, Transmit Line Code, 3-94
- B8ZS, Transmit Line Code, 3-94

- Baud Rate
 - PRINTER SETUP, 3-205
 - REMOTE CONTROL, 3-209
- Beeper, MISC SETTINGS, 3-61, 3-201
- BITS, Transmit Clock, 3-69
- BITS rear-panel connector, G-7
- BR, APS COMMANDS, 3-170
- BR&SW, APS COMMANDS, 3-170
- Bridge, Receive Level, 3-124
- bright text, 2-16
- Burst, 3-153, 3-155
 - Pointer Control, 3-143
- Burst Size, POINTERS & TIMING, 3-143
- buttons
 - AUTOSCAN, 3-55
 - CLEAR HISTORY, 2-5, 3-60
 - HELP, 2-12
 - INSERT ERROR, 3-133
 - menu, 2-11
 - ON/STBY, 1-9, 1-10
 - POINTER ACTION, 3-142
 - principal power switch, 1-9
 - PRINT, 3-197
 - START/STOP, 3-27, 3-49

C

- Change Bottom, HISTORY GRAPHS, 3-191
- Change Top, HISTORY GRAPHS, 3-190
- changing. *See* editing

Channel Requesting, APS COMMANDS, 3-165, 3-167

checking

APS response, 3-161

continuity, 3-2

error and alarm response, 3-8

fault tolerance, 3-8

line frequency offset response, 3-16

mapping and demapping, 3-6

pointer movements, 3-13

signal quality, 3-4

Clear

Description

SAVE PASS/FAIL TESTS, 3-45

SAVE RESULTS, 3-193

Name

SAVE PASS/FAIL TESTS, 3-45

SAVE RESULTS, 3-192

Operator End Prompt, 3-48

Operator Start Prompt, 3-46

CLEAR HISTORY button, 2-5, 3-60

Company Name, PRINTER SETUP, 3-206

connecting signals, 2-13

connectors

front panel, 2-3

rear panel, 2-4

Continuous, Test Duration, 3-23

controls, front panel, 2-2

Cool Down Period, 3-152

Cool Down Time, POINTERS & TIMING, 3-159

cooling requirements, 1-7

Coupled, Tx/Rx Settings

RECEIVE SETTINGS, 3-102, 3-123

TRANSMIT SETTINGS, 3-66, 3-91

coupling settings, 3-65, 3-101

Current Date, MISC SETTINGS, 3-202

Current Time, MISC SETTINGS, 3-202

D

D1-D3

External Add, 3-85

External Drop, 3-118

D4-D12

External Add, 3-85

External Drop, 3-118

Data Carrier, REMOTE CONTROL, 3-209

Data Communication Channel, 3-84, 3-117

date, setting, 3-202

Day, Test Duration, 3-25

DCC, G-5

adding, 3-84

dropping, 3-117

Dec, GPIB Primary Address,

REMOTE CONTROL, 3-207

Decrement, Pointer Direction, 3-148

Default

Operator End Prompt, 3-48

Operator Start Prompt, 3-46

- Default (XXXXXXXX), TRANSPORT OVERHEAD, 3-79
- Default 0ppm, Frequency Offset, 3-150
- Default 4, GPIB Primary Address, REMOTE CONTROL, 3-207
- Default 50ms, Pointer Rate, 3-147
- Default 522, Pointer Value Set to, 3-145
- Default 78, Pointer Value Set to, 3-146
- default settings, C-1
- Default Trace, J1 byte, 3-83
- Delete, Edit Mode, 2-22
- Delete File
 - RECALL INSTRUMENT SETUPS, 3-36
 - RECALL PASS/FAIL TESTS, 3-53
 - RECALL RESULTS, 3-195
- deleting a pass/fail test from disk, 3-53
- deleting test results, 3-195
- deleting text, 2-22
- Description
 - SAVE INSTRUMENT SETUPS, 3-33
 - SAVE PASS/FAIL TESTS, 3-38, 3-45
 - SAVE RESULTS, 3-193
- Destination Node ID, APS COMMANDS, 3-165
- Detected, SAVE PASS/FAIL TESTS, 3-39
- dimmed text, 2-16
- Disk
 - RECALL INSTRUMENT SETUPS, 3-34
 - RECALL PASS/FAIL TESTS, 3-52
 - RECALL RESULTS, 3-194, 3-195
 - SAVE PASS/FAIL TESTS, 3-50
- disk drive, 2-23
- disk file names, reading, 2-24
- Display Brightness, MISC SETTINGS, 3-200
- displaying history graphs, 3-182
- displaying results, 3-173, 3-175, 3-177
- DNR, APS COMMANDS, 3-164
- Do Nothing, On Test Completion, 3-49
- DONE, Edit Mode, 2-19, 2-21, 2-23
- Double Alternating, 3-155, 3-156
- Dropped Rx Clock, Overhead Add/Drop Port, G-6
- Dropped Rx Data, Overhead Add/Drop Port, G-6
- dropping a tributary signal, 3-110
- DS1 add, 3-72
- DS1 drop, 3-110
- DS1 ESF
 - DS1 Framing, 3-108, 3-128
 - Framing, 3-95, 3-125
 - Payload, 3-74, 3-111
- DS1 Ext Add, Payload, 3-74
- DS1 Path Analysis, ERROR ANALYSIS, 3-181

DS1 SF (D4)
 DS1 Framing, 3-108, 3-128
 Framing, 3-94, 3-125
 Payload, 3-74, 3-111
DS1 Unframed
 DS1 Framing, 3-108, 3-128
 Framing, 3-94, 3-125
 Payload, 3-74, 3-111
DS1/DS3 AIS, status light, 3-60
DS1/DS3 Option, INSTR CONFIG, 3-200
DS1/DS3 YELLOW, status light, 3-60
DS3, Mapping, 3-71, 3-73, 3-106
DS3 Analysis, ERROR ANALYSIS, 3-181
DS3 C-bit
 Framing, 3-95, 3-125
 Payload, 3-75, 3-111
DS3 drop, 3-110
DS3 Ext Add, Payload, 3-75
DS3 Idle, Transmit alarm set to, 3-137
DS3 M13
 Framing, 3-95, 3-125
 Payload, 3-75, 3-111
DS3 Unframed
 Framing, 3-95, 3-125
 Payload, 3-75, 3-111
DS3->DS1 Demux, Mapping, 3-106
DSn AIS, Transmit alarm set to, 3-137
DSn Path Analysis, 3-177
DSn Yellow, Transmit alarm set to, 3-137

E

EDIT BYTE
 K1 Full Byte, 3-163
 K2 Full Byte, 3-167
 Test Pattern, 3-97
 TRANSPORT OVERHEAD, 3-79
edit mode, 2-19
EDIT NAME, Name
 SAVE INSTRUMENT SETUPS, 3-32
 SAVE PASS/FAIL TESTS, 3-45
 SAVE RESULTS, 3-193
EDIT TEXT
 Description
 SAVE PASS/FAIL TESTS, 3-45
 SAVE RESULTS, 3-193
 Operator End Prompt, 3-48
 Operator Start Prompt, 3-46
EDIT TRACE, J1 byte, 3-83
Edit XX bits, Test Pattern, 3-97
editing
 binary numbers, 2-20
 bytes, 2-20
 decimal numbers, 2-17
 text, 2-21, 2-22
electrical connections, 2-13
Enter, Edit Mode, 2-22
entering text, 2-22
ERROR, status light, 3-60
Error Count, Fail If condition, 3-41
error messages, B-3
error rate, 3-133
 maximum, 3-133

- Error Ratio, Fail If condition, 3–39
 - Error type set to, ERRORS & ALARMS, 3–132
 - Errored Seconds, Fail If condition, 3–42
 - Errors, MAIN RESULTS, 3–175, 3–177
 - example disk contents, F–1
 - EXER, APS COMMANDS, 3–164
 - EXER–R, APS COMMANDS, 3–163
 - EXER–S, APS COMMANDS, 3–163
 - EXIT
 - Help dialog box, 2–13
 - PRINT CONTROL dialog box, 3–197, 3–198
 - External Add
 - PATH OVERHEAD, 3–86
 - TRANSPORT OVERHEAD, 3–85
 - External BITS, Transmit Clock, 3–93
 - External Drop
 - PATH OVERHEAD, 3–119
 - TRANSPORT OVERHEAD, 3–117
 - External DSn, Transmit Clock, 3–93
 - external monitor connector, G–1
- F**
- F1
 - External Add, 3–85
 - External Drop, 3–118
 - F2
 - External Add, 3–86
 - External Drop, 3–119
 - Fail If conditions, Pass/Fail Test, 3–38
 - Failure, Fail If condition, 3–39
 - Failure set to, ERRORS & ALARMS, 3–138
 - Failures, MAIN RESULTS, 3–175, 3–177
 - FERF, APS COMMANDS, 3–170
 - 15 min, Test Duration, 3–23
 - files, disk, 2–23
 - Firmware Revision, INSTR CONFIG, 3–199
 - 5 min, Test Duration, 3–23
 - Flow Control, PRINTER SETUP, 3–205
 - 4 x STS-3c, Signal Structure, TRANSMIT SETTINGS, 3–70
 - Framing, RECEIVE SETTINGS, 3–124
 - Frequency Offset
 - Pointer/Timing Mode, 3–149
 - POINTERS & TIMING, 3–150
 - FS, APS COMMANDS, 3–165
 - FS–R, APS COMMANDS, 3–164
 - FS–S, APS COMMANDS, 3–164
 - fuse, 1–7
- G**
- GPIB connector, G–3
 - GPIB parameters, 3–206
 - GPIB Primary Address, REMOTE CONTROL, 3–207
 - GPIB programming. *See* Programmer Manual
 - green lights, 2–4, 3–59

H

Hardware Handshake, REMOTE CONTROL, 3–209
Hardware Revision, INSTR CONFIG, 3–199
HELP button, 2–12
Help dialog box, 2–12
High
 Receive Level, 3–103
 Transmit Level, 3–69
high-intensity text, 2–16
history graphs
 displaying, 3–182
 elements of, 3–186
 resolution, 3–189
 zooming, 3–188
History Resolution, 3–27
Hour, Test Duration, 3–25

I

icons, 2–8
IDLE, APS COMMANDS, 3–170
Illegal (Max +1), Pointer Value Set to, 3–145, 3–146
Inc, GPIB Primary Address, REMOTE CONTROL, 3–207
Increment, Pointer Direction, 3–148
Independent, Tx/Rx Settings
 RECEIVE SETTINGS, 3–102, 3–124
 TRANSMIT SETTINGS, 3–66, 3–92
Initialization Period, 3–152
Initialization Time, POINTERS & TIMING, 3–158
initializing the CTS, 3–35
INSERT ERROR button, 3–133
installation, 1–7

instrument setups
 creating, 3–32
 recalling, 3–34
Interface Module, INSTR CONFIG, 3–200
Internal, Transmit Clock, 3–68, 3–92

J

J1 Path Trace byte
 editing, 3–82
 viewing, 3–116, 3–117

K

K1 Full Byte, APS COMMANDS, 3–162
K2 Full Byte, APS COMMANDS, 3–167
knob, 2–3
knob icon, 2–19

L

lights
 red, 3–60
 status, 2–4, 3–58
 yellow, 3–60
Line
 ERROR ANALYSIS, 3–177, 3–178
 Offset Mode, 3–150
LINE AIS, status light, 3–60
Line AIS, Transmit alarm set to, 3–136
Line Clock Offset, TRANSMIT SETTINGS, 3–93
Line DCC, Overhead Add/Drop Port, G–5, G–6

LINE FERF, status light, 3–60
Line FERF, Transmit alarm set to,
3–136
line rate, 3–64, 3–90
LOF
Failure set to, 3–138
status lights, 3–60
LONG, APS COMMANDS, 3–169
LOP, status light, 3–60
LOS
Failure set to, 3–138
status light, 3–60
Low, Receive Level, 3–103
Low (15 min), History Resolution,
3–27
LP, APS COMMANDS, 3–165
LP–S, APS COMMANDS, 3–164

M

manuals, related, xxii
Mapping, TRANSMIT SET-
TINGS, 3–71
mapping a tributary signal, 3–72
Mapping line, RECEIVE SET-
TINGS page, 3–105
Max +100ppm, Frequency Offset,
3–150
Max 103, Pointer Value Set to,
3–146
Max 2ms, Pointer Rate, 3–147
Max 48ms, Pointer Rate, 3–147
Max 782, Pointer Value Set to,
3–145
Memory
RECALL INSTRUMENT SET-
UPS, 3–34
RECALL RESULTS, 3–196

Memory 1–6, Save to Memory,
3–33
menu pages, 2–9
menus
RECEIVE, 2–9
RESULTS, 2–9
TEST SETUPS, 2–9
TRANSMIT, 2–9
UTILITY, 2–9
Min 0, Pointer Value Set to, 3–144,
3–146
Min 10000ms, Pointer Rate, 3–147
mini-graphs, 3–191
Minimum Res, history graphs,
3–186
Minute, Test Duration, 3–25
Model, INSTR CONFIG, 3–199
Monitor, Receive Level, 3–103,
3–124
monitoring performance, 3–18
–more– indicator, 2–16
MS, APS COMMANDS, 3–164
MS–R, APS COMMANDS, 3–163
MS–S, APS COMMANDS, 3–163

N

Name
SAVE INSTRUMENT SETUPS,
3–32
SAVE PASS/FAIL TESTS, 3–37,
3–44
SAVE RESULTS, 3–192
network stress testing, 3–135
Next, VT Under Test, 3–74
No Mapping (Equipped), Mapping,
3–71

No Mapping (Unequipped), Mapping, 3-71, 3-72

None

Description

SAVE PASS/FAIL TESTS, 3-45

SAVE RESULTS, 3-193

Error type set to, 3-133

External Add, 3-85

PATH OVERHEAD, 3-86

External Drop

PATH OVERHEAD, 3-119

TRANSPORT OVERHEAD, 3-118

Failure set to, 3-138

Transmit alarm set to, 3-136

none, in tables, xxii

Normal, Receive Level, 3-124

Normal (1 min), History Resolution, 3-27

Not Detected, SAVE PASS/FAIL TESTS, 3-39

NR, APS COMMANDS, 3-163, 3-164

Null Trace, J1 byte, 3-83

O

Offline, GPIB Primary Address, REMOTE CONTROL, 3-207

Offset Mode, POINTERS & TIMING, 3-150

On, Tributary Drop, 3-112

On AMI, Tributary Drop, 3-112

On B8ZS, Tributary Drop, 3-112

On Test Completion, SAVE PASS/FAIL TESTS, 3-38

1 hour, Test Duration, 3-23

1 in 8, Test Pattern, 3-75, 3-96, 3-126

1+1, APS COMMANDS, 3-169

1:N, APS COMMANDS, 3-169

1 x STS-3c, Signal Structure, TRANSMIT SETTINGS, 3-70

#1-15, APS COMMANDS, 3-166, 3-168

Operator End Prompt, SAVE PASS/FAIL TESTS, 3-38, 3-48

Operator Start Prompt, SAVE PASS/FAIL TESTS, 3-38, 3-46

optical connections, 2-13

Options, INSTR CONFIG, 3-199

overhead bytes, 3-77

editing, 3-77

viewing, 3-115

P

packaging for shipment, I-1

page tabs, 2-7, 2-9

pages, 2-9

parameters

changing, 2-15

selecting, 2-16

Parity

PRINTER SETUP, 3-205

REMOTE CONTROL, 3-209

Pass/Fail test

condition type, 3-38

creating, 3-37, 3-44

specific condition, 3-38

starting, 3-49

threshold, 3-38

Path

APS COMMANDS, 3-169

ERROR ANALYSIS, 3-177

PATH AIS, status light, 3-60

Path AIS, Transmit alarm set to, 3-136

Path Analysis, ERROR ANALYSIS, 3-177, 3-179

PATH FERF, status light, 3-60

- Path FERF, Transmit alarm set to, 3-136
- Path Overhead, viewing, 3-80, 3-116, 3-117
- path overhead bytes, setting, 3-77
- Path User Channel (F2), Overhead Add/Drop Port, G-5, G-6
- PATTERN LOCK, status light, 3-59
- Pause Control line, PATH OVERHEAD page, 3-120
- Payload, Offset Mode, 3-150
- Payload Analysis, ERROR ANALYSIS, 3-177, 3-180
- payload mapping, 3-104
 - DS3, 3-110
 - setting, 3-71
 - unequipped, 3-114
 - VT1.5 Floating Async, 3-72, 3-110
- performance monitoring, 3-18
- Periodic 26-1, 3-154, 3-156
 - With Add, 3-155, 3-156
 - With Cancel, 3-155, 3-156
- Periodic 87-3, 3-154, 3-156
 - With Add, 3-154, 3-156
 - With Cancel, 3-154, 3-156
- Periodic Continuous, 3-153, 3-156
 - With Add, 3-154, 3-156
 - With Cancel, 3-156
 - with Cancel, 3-153
- Phase Transient, 3-153, 3-155
- pin assignments
 - Overhead Add/Drop Port, G-5
 - RS-232, G-3
 - VGA video output, G-1
- Pointer, Fail If condition, 3-43
- POINTER ACTION button, 3-142
- POINTER ADJ, status light, 3-60
- pointer adjust mode, 3-141
- Pointer Control, POINTERS & TIMING, 3-147
- Pointer Direction, POINTERS & TIMING, 3-148, 3-157
- Pointer Rate, POINTERS & TIMING, 3-147, 3-158
- Pointer S-Bits, Pointers & Timing, 3-146
- Pointer Type, POINTERS & TIMING, 3-142, 3-157
- Pointer Value Set to, POINTERS & TIMING, 3-144, 3-145
- Pointer/Timing Mode, POINTERS & TIMING, 3-141, 3-149, 3-156
- Pointers, MAIN RESULTS, 3-175, 3-177
- power connector, 1-9
- power requirements, 1-9
- POWEROUT, history graphs, 3-187
- Preview
 - Operator End Prompt, 3-48
 - Operator Start Prompt, 3-46
- Previous, VT Under Test, 3-74
- Print
 - AutoScan dialog box, 3-58
 - PRINT CONTROL dialog box, 3-197, 3-198
- PRINT button, 3-197
- Print Error Analysis, PRINT CONTROL dialog box, 3-197
- Print Last Screen, PRINT CONTROL dialog box, 3-198
- Print Main Results, PRINT CONTROL dialog box, 3-197
- Print Summary, On Test Completion, 3-49
- Print User & Company, PRINTER SETUP, 3-206

printer setup, 3–203
Printer Type, PRINTER SETUP,
3–204
printers
RS-232 parameters, 3–204
supported, 3–204
printing results, 3–196
Programmer Manual, xxii

R

reading disk file names, 2–24
Recall, RECALL PASS/FAIL
TESTS, 3–50
Recall Result, RECALL RE-
SULTS, 3–194, 3–196
Recall Setup, RECALL INSTRU-
MENT SETUPS, 3–34, 3–35
RECEIVE, APS COMMANDS,
3–172
RECEIVE button, 2–11
Receive Level, RECEIVE SET-
TINGS, 3–103, 3–124
Receive Rate, RECEIVE SET-
TINGS, 3–100, 3–122
receive settings, coupled vs. inde-
pendent, 3–101
Received Optical Power, SIGNAL
STATUS, 3–114
Received Peak Voltage, SIGNAL
STATUS, 3–114
Recovered, Transmit Clock, 3–68,
3–93
red lights, 2–4, 3–60
Reference (programmer), xxii
Reference manual, xxii
repackaging for shipment, I–1

Reset Overhead
J1 byte, PATH OVERHEAD,
3–83
TRANSPORT OVERHEAD,
3–79
RESLT_XX, Name, SAVE RE-
SULTS, 3–192
results, displaying, 3–175, 3–177
RESULTS button, 2–11
Ring, APS COMMANDS, 3–161
RR, APS COMMANDS, 3–164
RR–R, APS COMMANDS, 3–163
RR–S, APS COMMANDS, 3–163
RS-232 connector, G–3
RS-232 parameters, 3–208
Run, Self Test Control, 3–211
Rx Common, Overhead Add/Drop
Port, G–6
Rx Frame Pulse, Overhead Add/
Drop Port, G–7

S

S–Bits, Pointers, Pointers & Tim-
ing, 3–146
Save Current, Disk Operation,
SAVE RESULTS, 3–194
Save File
Disk Operation, 3–52
SAVE PASS/FAIL TESTS,
3–49
SAVE INSTRUMENT SETUPS,
3–34
Save Previous, Disk Operation,
SAVE RESULTS, 3–194

- Save to Disk
 - On Test Completion, 3-49
 - SAVE INSTRUMENT SETUPS, 3-34
 - SAVE RESULTS, 3-194
- Save to Memory, SAVE INSTRUMENT SETUPS, 3-33
- saving test results, 3-192
- Scan All VTs, AUTOSCAN dialog box, 3-57
- SD-HP, APS COMMANDS, 3-164
- SD-LP, APS COMMANDS, 3-164
- SD-P, APS COMMANDS, 3-163
- SD-R, APS COMMANDS, 3-163
- SD-S, APS COMMANDS, 3-163
- Second, Test Duration, 3-25
- Section, ERROR ANALYSIS, 3-177, 3-178
- Section DCC, Overhead Add/Drop Port, G-5, G-6
- Section User Channel (F1), Overhead Add/Drop Port, G-5, G-6
- selected parameter, 2-7
- self test, 1-10, 3-210
- Sequence Period, 3-152
- Sequence Type, POINTERS & TIMING, 3-157
- Serial Number, INSTR CONFIG, 3-199
- Service Manual, xxii
- SET DATE, MISC SETTINGS, 3-202
- SET TIME, MISC SETTINGS, 3-202
- Set Value, Pointer Control, 3-144
- Set with New Data Flag, POINTERS & TIMING, 3-146
- settings, default, 3-35, C-1
- SETUP_XX, Name, SAVE INSTRUMENT SETUPS, 3-32
- SF-HP, APS COMMANDS, 3-165
- SF-LP, APS COMMANDS, 3-164
- SF-R, APS COMMANDS, 3-163
- SF-S, APS COMMANDS, 3-164
- SHORT, APS COMMANDS, 3-169
- Show Next Top, HISTORY GRAPHS, 3-190
- Showing Overhead for, TRANSPORT OVERHEAD, 3-78, 3-116
- SIGNAL PRESENT, status light, 3-59
- signal status, checking, 3-55
- signal status indicators, 2-7
- Signal Structure, RECEIVE SETTINGS, 3-103
- Single, 3-153, 3-155
 - Pointer Control, 3-142
- Single Alternating, 3-155, 3-156
- Software Handshake, REMOTE CONTROL, 3-209
- Source Node ID, APS COMMANDS, 3-167
- Span, APS COMMANDS, 3-161
- standard accessories, 1-2
- START/STOP button, 3-27, 3-49
- Status, APS COMMANDS, 3-170
- status lights, 2-4, 2-5, 3-58-3-62
- status messages, B-1
- Stop Bits
 - PRINTER SETUP, 3-205
 - REMOTE CONTROL, 3-209
- Stress +4.6ppm, Frequency Offset, 3-150
- Stress -4.6ppm, Frequency Offset, 3-150
- STS LOP, Failure set to, 3-138
- STS Under Test
 - RECEIVE SETTINGS, 3-104
 - TRANSMIT SETTINGS, 3-70

STS-1, Signal Structure, RECEIVE SETTINGS, 3-104

STS-3c, Signal Structure, RECEIVE SETTINGS, 3-104

symbols (icons) in display, 2-8

T

TEST BEGIN dialog box, 3-50

Test Duration

SAVE PASS/FAIL TESTS, 3-38, 3-47

TEST TIME, 3-23

test duration limits, 3-26

Test Pattern

RECEIVE SETTINGS, 3-125

TRANSMIT SETTINGS, 3-75, 3-96

test results, displaying, 3-173

TEST SETUPS button, 2-11

test state indicator, 2-7

TEST_XX, Name, SAVE PASS/FAIL TESTS, 3-44

tests

actions not allowed during, 3-28

changes not allowed during, 3-28

setting history resolution, 3-27

setting test duration, 3-23, 3-25

starting and stopping, 3-27-3-30

3 in 24, Test Pattern, 3-75, 3-96

3 x STS-1, Signal Structure,

TRANSMIT SETTINGS, 3-70

Through Mode, Transmit Rate, 3-67

time, setting, 3-202

To Disk BMP Format, 3-204

To Disk EPS Format, 3-204

To Disk Ileaf Format, 3-204

Transmit alarm set to, ERRORS & ALARMS, 3-135

TRANSMIT button, 2-11

Transmit Clock, TRANSMIT SETTINGS, 3-68, 3-92

TRANSMIT column, APS COMMANDS, 3-170

Transmit Default, Transmit Setup, 3-171

Transmit Illegal, Transmit Setup, 3-171

Transmit Level, TRANSMIT SETTINGS, 3-69

transmit parameters, 3-63

Transmit Rate, TRANSMIT SETTINGS, 3-64, 3-90

transmit settings, coupled vs. independent, 3-65, 3-90

Transmit Setup, APS COMMANDS, 3-171

Transmit User Setup, Transmit Setup, 3-171

transport overhead bytes, 3-77

tributary signal, dropping, 3-110

TroubleScan, 3-173

turn on sequence, 1-9

12 x STS-1, Signal Structure, TRANSMIT SETTINGS, 3-70

Tx Common, Overhead Add/Drop Port, G-6

Tx Delay (Seconds), REMOTE CONTROL, 3-209

Tx Frame Pulse, Overhead Add/Drop Port, G-7

Tx Terminator, REMOTE CONTROL, 3-210

Tx/Rx Settings

RECEIVE SETTINGS, 3-102, 3-123

TRANSMIT SETTINGS, 3-65, 3-66, 3-90, 3-91, 3-92

Tx/Rx Settings line, RECEIVE
SETTINGS page, 3-101

U

Unknown, Test Pattern, 3-129
RECEIVE SETTINGS, 3-109,
3-113, 3-126
USER, Fail If table, SAVE PASS/
FAIL TESTS, 3-48
User Channel, G-5
adding, 3-84
dropping, 3-117
USER DEFINED
Error rate set to, 3-135
Frequency Offset, 3-150
Line Clock Offset, 3-93
Pointer Rate, 3-147
Pointer Value Set to, 3-145
Test Duration
SAVE PASS/FAIL TESTS,
3-47
TEST CONTROL, 3-24
User Name, PRINTER SETUP,
3-206
User Trace, J1 byte, 3-83
User Word, Test Pattern, RECEIVE
SETTINGS, 3-109, 3-113,
3-129
User Word 16 bit, Test Pattern,
3-75
RECEIVE SETTINGS, 3-126
TRANSMIT SETTINGS, 3-96
User Word 24 bit, Test Pattern,
3-75
RECEIVE SETTINGS, 3-126
TRANSMIT SETTINGS, 3-96
User Word 8 bit, Test Pattern, 3-75
RECEIVE SETTINGS, 3-126
TRANSMIT SETTINGS, 3-96

UTILITY button, 2-11

V

V5 byte, editing, 3-80
VGA connector, G-1
View Help, Help dialog box, 2-12
viewing APS response, 3-172
VT 1.5 Analysis, ERROR ANAL-
YSIS, 3-179
VT 1.5 Async, Mapping, 3-71,
3-105
VT AIS
status light, 3-60
Transmit alarm set to, 3-136
VT FERF
status light, 3-60
Transmit alarm set to, 3-137
VT LOM, Failure set to, 3-138
VT LOP, Failure set to, 3-138
VT#1, VT Under Test, 3-74
VT#28, VT Under Test, 3-74
VT1.5 Async, Mapping, 3-73
VT1.5 Floating Async payload
mapping, 3-72, 3-110
VT1.5 Overhead, 3-116

W

WTR, APS COMMANDS, 3-163,
3-164

X

XConnect
Receive Level, 3-103
Transmit Level, 3-69

Y

yellow lights, 2–5, 3–60

Z

0. DEFAULT memory, RECALL
INSTRUMENT SETUPS page,
3–35

Zoom In, HISTORY GRAPHS,
3–189

Zoom Out, HISTORY GRAPHS,
3–189